

**PHILIPS**

Data handbook



Electronic  
components  
and materials

**Electron tubes**

**Book T10 1985**

**Plumbicon camera tubes and accessories**

**Elcoma** – Philips Electronic Components and Materials Division – embraces a world-wide group of companies operating under the following names:

**IBRAPE**

**PHILIPS**

**MBLE**



**Miniwatt**

**signetics**

**Mullard**

**VALVO**

Elcoma offers you a technological partnership in developing your systems to the full. A partnership to which we can bring

- world-wide production and marketing
- know-how
- systems approach
- continuity
- broad product line
- fundamental research
- leading technologies
- applications support
- quality

# PLUMBICON CAMERA TUBES AND ACCESSORIES

|  | <i>page</i> |
|--|-------------|
| <b>General Section</b>                       |             |
| Principles of operation . . . . .            | 3           |
| Rating system . . . . .                      | 11          |
| Survey and type selection . . . . .          | 12          |
| Plumbicon tubes 30 mm . . . . .              | 13          |
| Plumbicon tubes 25,4 mm . . . . .            | 14          |
| Plumbicon tubes 18 mm . . . . .              | 15          |
| Plumbicon tubes 14 mm . . . . .              | 16          |
| Accessories . . . . .                        | 17          |
| General operational notes . . . . .          | 19          |
| Test specification. . . . .                  | 29          |
| <b>Device data</b>                           |             |
| 30 mm dia. Plumbicon tubes . . . . .         | 37          |
| 25,4 mm dia. Plumbicon tubes . . . . .       | 97          |
| 18 mm dia. Plumbicon tubes . . . . .         | 187         |
| 14 mm dia. Plumbicon tubes . . . . .         | 239         |
| Deflection and focusing assemblies . . . . . | 249         |
| <b>Index of type numbers. . . . .</b>        | <b>293</b>  |



## DATA HANDBOOK SYSTEM

Our Data Handbook System comprises more than 60 books with specifications on electronic components, subassemblies and materials. It is made up of four series of handbooks:

|                          |        |
|--------------------------|--------|
| ELECTRON TUBES           | BLUE   |
| SEMICONDUCTORS           | RED    |
| INTEGRATED CIRCUITS      | PURPLE |
| COMPONENTS AND MATERIALS | GREEN  |

The contents of each series are listed on pages iv to viii.

The data handbooks contain all pertinent data available at the time of publication, and each is revised and reissued periodically.

When ratings or specifications differ from those published in the preceding edition they are indicated with arrows in the page margin. Where application information is given it is advisory and does not form part of the product specification.

Condensed data on the preferred products of Philips Electronic Components and Materials Division is given in our Preferred Type Range catalogue (issued annually).

Information on current Data Handbooks and on how to obtain a subscription for future issues is available from any of the Organizations listed on the back cover.

Product specialists are at your service and enquiries will be answered promptly.

## ELECTRON TUBES (BLUE SERIES)

The blue series of data handbooks comprises:

- T1 Tubes for r.f. heating**
- T2a Transmitting tubes for communications, glass types**
- T2b Transmitting tubes for communications, ceramic types**
- T3 Klystrons**
- T4 Magnetrons for microwave heating**
- T5 Cathode-ray tubes**  
Instrument tubes, monitor and display tubes, C.R. tubes for special applications
- T6 Geiger-Müller tubes**
- T7 Gas-filled tubes (will not be reprinted)**
- T8 Picture tubes and components**  
Colour TV picture tubes, black and white TV picture tubes, colour monitor tubes for data graphic display, monochrome monitor tubes for data graphic display, components for colour television, components for black and white television and monochrome data graphic display
- T9 Photo and electron multipliers**
- T10 Plumbicon camera tubes and accessories**
- T11 Microwave semiconductors and components**
- T12 Vidicon and Newvicon camera tubes**
- T13 Image intensifiers**
- T14 Infrared detectors**
- T15 Dry reed switches**
- T16 Monochrome tubes and deflection units**  
Black and white TV picture tubes, monochrome data graphic display tubes, deflection units

} Data collations on these subjects are available now.  
Data Handbooks will be published in 1985.

## SEMICONDUCTORS (RED SERIES)

The red series of data handbooks comprises:

- S1 Diodes**  
Small-signal germanium diodes, small-signal silicon diodes, voltage regulator diodes ( $< 1,5 \text{ W}$ ), voltage reference diodes, tuner diodes, rectifier diodes
- S2a Power diodes**
- S2b Thyristors and triacs**
- S3 Small-signal transistors**
- S4a Low-frequency power transistors and hybrid modules**
- S4b High-voltage and switching power transistors**
- S5 Field-effect transistors**
- S6 R.F. power transistors and modules**
- S7 Surface mounted semiconductors**
- S8 Devices for optoelectronics**  
Photosensitive diodes and transistors, light-emitting diodes, displays, photocouplers, infrared sensitive devices, photoconductive devices.
- S9 Power MOS transistors**
- S10 Wideband transistors and wideband hybrid IC modules**
- S11 Microwave semiconductors** (to be published in this series in 1985)  
At present available in Handbook T11
- S12 Surface acoustic wave devices**

## INTEGRATED CIRCUITS (PURPLE SERIES)

The purple series of data handbooks comprises:

### EXISTING SERIES

Superseded by:

|             |  |                        |
|-------------|--|------------------------|
| <b>IC1</b>  | <b>Bipolar ICs for radio and audio equipment</b>   |                        |
| <b>IC2</b>  | <b>Bipolar ICs for video equipment</b>   | <b>IC02N</b>           |
| <b>IC3</b>  | <b>ICs for digital systems in radio, audio and video equipment</b>   |                        |
| <b>IC4</b>  | <b>Digital integrated circuits</b><br>CMOS HE4000B family  |                        |
| <b>IC5</b>  | <b>Digital integrated circuits – ECL</b><br>ECL10 000 (GX family), ECL100 000 (HX family), dedicated designs | <b>IC08N</b>           |
| <b>IC6</b>  | <b>Professional analogue integrated circuits</b>   |                        |
| <b>IC7</b>  | <b>Signetics bipolar memories</b>  |                        |
| <b>IC8</b>  | <b>Signetics analogue circuits</b>   | <b>IC11N</b>           |
| <b>IC9</b>  | <b>Signetics TTL logic</b>   | <b>IC09N and IC15N</b> |
| <b>IC10</b> | <b>Signetics Integrated Fuse Logic (IFL)</b>   | <b>IC13N</b>           |
| <b>IC11</b> | <b>Microprocessors, microcomputers and peripheral circuitry</b>  |                        |



## NEW SERIES

|              |  |                  |
|--------------|--|------------------|
| <b>IC01N</b> | <b>Radio, audio and associated systems</b><br>Bipolar, MOS                 |                  |
| <b>IC02N</b> | <b>Video and associated systems</b><br>Bipolar, MOS                        | (published 1985) |
| <b>IC03N</b> | <b>Telephony equipment</b><br>Bipolar, MOS                                 |                  |
| <b>IC04N</b> | <b>HE4000B logic family</b><br>CMOS  |                  |
| <b>IC05N</b> | <b>HE4000B logic family uncased integrated circuits</b><br>CMOS            | (published 1984) |
| <b>IC06N</b> | <b>High-speed CMOS; PC54/74HC/HCT/HCU</b><br>Logic family                  | (published 1985) |
| <b>IC07N</b> | <b>PC54/74HC/HCU/HCT uncased integrated circuits</b><br>HCMOS              |                  |
| <b>IC08N</b> | <b>10K and 100K logic family</b><br>ECL                                    | (published 1984) |
| <b>IC09N</b> | <b>Logic series</b><br>TTL   | (published 1984) |
| <b>IC10N</b> | <b>Memories</b><br>MOS, TTL, ECL   |                  |
| <b>IC11N</b> | <b>Linear LSI</b>  | (published 1985) |
| <b>IC12N</b> | <b>Semi-custom gate arrays &amp; cell libraries</b><br>ISL, ECL, CMOS      |                  |
| <b>IC13N</b> | <b>Semi-custom</b><br>Integrated Fuse Logic                                | (published 1985) |
| <b>IC14N</b> | <b>Microprocessors, microcontrollers &amp; peripherals</b><br>Bipolar, MOS |                  |
| <b>IC15N</b> | <b>Logic series</b><br>FAST TTL  | (published 1984) |

### Note

Books available in the new series are shown with their date of publication.

## COMPONENTS AND MATERIALS (GREEN SERIES)

The green series of data handbooks comprises:

- C1 Programmable controller modules**  
PLC modules, PC20 modules
- C2 Television tuners, coaxial aerial input assemblies, surface acoustic wave filters**
- C3 Loudspeakers**
- C4 Ferroxcube potcores, square cores and cross cores**
- C5 Ferroxcube for power, audio/video and accelerators**
- C6 Synchronous motors and gearboxes**
- C7 Variable capacitors**
- C8 Variable mains transformers**
- C9 Piezoelectric quartz devices**
- C10 Connectors**
- C11 Non-linear resistors**  
Voltage dependent resistors (VDR), light dependent resistors (LDR), negative temperature coefficient thermistors (NTC), positive temperature coefficient thermistors (PTC)
- C12 Potentiometers, encoders and switches**
- C13 Fixed resistors**
- C14 Electrolytic and solid capacitors**
- C15 Ceramic capacitors**
- C16 Permanent magnet materials**
- C17 Stepping motors and associated electronics**
- C18 Direct current motors**
- C19 Piezoelectric ceramics**
- C20 Wire-wound components for TVs and monitors**
- C21 Assemblies for industrial use**  
HNIL FZ/30 series, NORbits 60-, 61-, 90-series, input devices
- C22 Film capacitors**

## GENERAL SECTION



## PRINCIPLES OF OPERATION

### 1 PHOTOCONDUCTIVE CAMERA TUBES

#### 1.1 General description

A lens system focuses an image of the scene to be televised onto the faceplate of the camera tube. A photoconductive layer on the faceplate converts this image into a charge distribution which is then scanned line-by-line by an electron beam and transformed into an electrical signal.

Figure 1 illustrates the electrode and coil arrangement for a vidicon or Plumbicon tube with magnetic focusing and deflection. An electron gun produces the scanning electron beam, which is directed by the focusing and deflection coils to land upon a target containing the photoconductive layer.

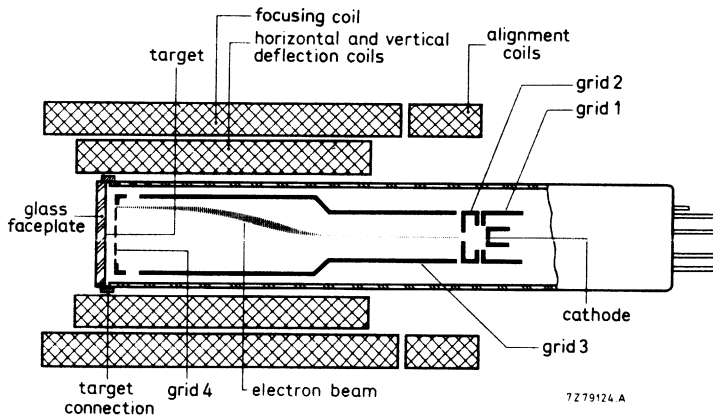

Fig. 1 Electrode and coil arrangement of a vidicon or Plumbicon tube.

The electron gun comprises an indirectly heated cathode and grids 1 to 4. The voltage on grid 1 controls the electron beam current. Grid 2 (first anode) accelerates the electrons, which subsequently pass through a cylindrical electrode (grid 3) and a fine mesh (grid 4), which establishes a uniform decelerating field in front of the target.

The focusing coil produces an axial magnetic field that, in combination with an appropriate voltage applied to grid 3, focuses the beam on the target. Focusing can be adjusted by varying either the grid 3 voltage or the focusing coil current.

Two sets of alignment coils produce an adjustable transverse magnetic field, enabling the beam to be aligned parallel to the tube axis so that it lands perpendicularly on the target.

Finally, two sets of deflection coils supply the varying magnetic field needed to deflect the beam for line-by-line scan of the target.

The target section is illustrated in Fig. 2. It consists of:

- an optically flat faceplate;
- a transparent conductive film on the inner surface of the faceplate, connected electrically to the external signal electrode contact;
- a thin layer of photoconductive material deposited on the conductive film. In darkness this material has a high specific resistance which decreases with increasing illumination.

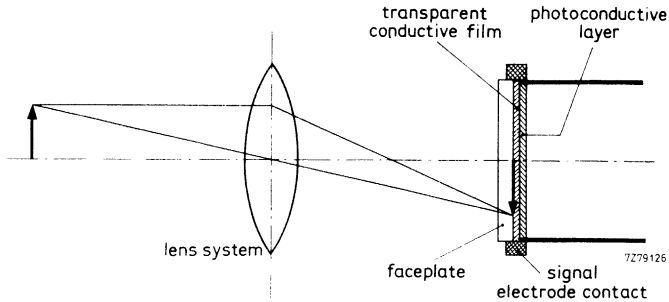

Fig. 2 Target section.

## 1.2 Operation

The external signal electrode contact is connected via a load resistor to a positive voltage of e.g. 45 V, see Fig. 3. The target may be assumed to consist of a large number of target elements corresponding to the number of picture elements. Each target element may be represented by a small capacitor  $C_e$ , connected on one side to the signal electrode via the transparent conductive film and shunted by a light dependent resistor  $R_e$ .

When the target is scanned, beam electrons — approaching the target at a low velocity — will continue to land until the scanned surface is approximately at cathode potential. This is called cathode potential stabilization. In this way a voltage difference is established across the layer, with each element capacitor charged to nearly the same potential as that applied to the signal electrode.

In the dark, the photoconductive material is a fairly good insulator, so that only a minute fraction of the charge of the element capacitors will leak away between successive scans. This fraction will be restored by the beam and the resulting current to the signal electrode is called 'dark current'.

When an optical image is focused on the target, those target elements which are illuminated will become conductive and will be partly discharged. As a consequence of this a pattern of positive charges corresponding to the optical image will be produced on the side of the target facing the electron gun.

While scanning this charge pattern, the electron beam will deposit electrons on the positive elements until the latter are restored to their original cathode potential, causing a capacitive current to the signal electrode — and hence a voltage across the load resistor  $R_L$ . This voltage is the video signal and is fed to the preamplifier.

A camera tube is called 'stabilized' when the magnitude of the beam current is sufficient to restore the scanned surface to the cathode potential. All element capacitors, including those at the highlights of the image, are then completely recharged by the passing electron beam.

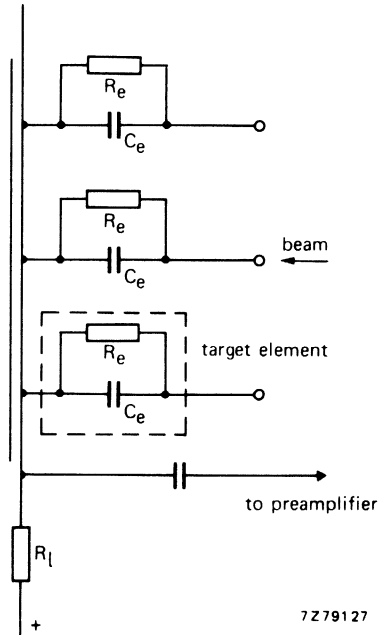

Fig. 3.

### 1.3 Separate mesh construction

The focusing coils commonly used do not produce an ideal focusing field distribution in the vicinity of the target. The resulting 'landing errors' of the scanning beam (non-perpendicular landing outside the central area) may cause picture defects such as geometrical distortion and 'stern waves' behind moving objects. An electron-optical lens formed between grids 3 and 4 can correct these landing errors. The grids are electrically separated with grid 4 (the mesh) positive relative to grid 3. Lens action is governed by the ratio of voltages on grids 3 and 4, the optimum ratio depending upon factors such as electron gun construction and type of coil assembly used.

Besides eliminating landing errors, separate-mesh construction reduces the space charge in the field-free region near the mesh, and so provides the bonus of improved resolution compared with the integral mesh (in which grids 3 and 4 are internally connected). Moreover, since this space charge increases with increasing beam current, separate mesh tubes can operate with higher beam currents than integral mesh tubes.

All currently available Plumbicon tubes have separate mesh construction. Some vidicon tubes, however, have integral meshes.

### 1.4 Electrostatic focus

Focusing and deflection may both be electrostatic. Figure 4 shows a possible arrangement of electrodes and coils for a camera tube with electrostatic focusing and magnetic deflection.

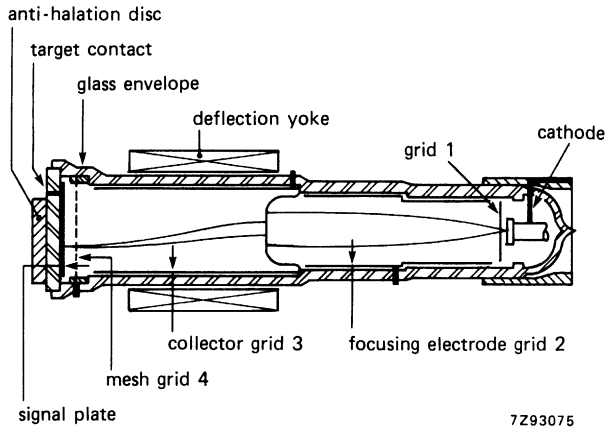

Fig. 4 Schematic electrode and coil arrangement with electrostatic focusing.

In an electrostatically focused tube the electron gun includes an indirectly heated cathode, a control electrode (grid 1), a focusing electrode (grid 2), a cylindrical electrode (grid 3) and a fine mesh (grid 4). Since this tube uses no focusing coils, it dissipates significantly less power than the magnetically focused tube.

**1.5 Anti-comet-tail gun**

To cope with extreme highlights, which cannot be stabilized with normal beam currents, a special electron gun known as the anti-comet-tail (ACT) gun has been developed. The General Operational Notes on Plumbicon tubes give a short description of this gun.

**1.6 The diode gun**

In the diode gun grid 1 is made positive relative to the cathode. This modifies the electron beam and provides larger beam reserve for highlight handling. A brief description of the diode gun will be found in the General Operational Notes on Plumbicon tubes.

**2 MAIN PROPERTIES**

**2.1 Luminous sensitivity**

The *luminous sensitivity*,  $S_L$ , of a camera tube is defined as the *average* signal current,  $I_s$ , generated per unit luminous flux falling uniformly on the scanned area,  $A$ , of its target; i.e.

$$S_L = \frac{I_s}{AB_{ph}} \text{ } \mu\text{A/lumen}$$

in which  $B_{ph}$  is the illuminance of the photoconductive layer (in lumens/m<sup>2</sup>).



Often, what is of interest to the camera designer is not the average signal current, but the current,  $I_p$ , over the active scanning line, since this a better indication of the peak signal currents likely to occur in practice. For a camera tube with a blanking period  $\beta$  (given as a percentage of the total line period), the signal current  $I_p$  is given by:

$$I_p = \frac{100}{100 - \beta} I_s = \alpha I_s.$$

For the CCIR system  $\alpha = 1.3$ .

For a black/white camera, the illuminance,  $B_{ph}$ , of the photoconductive layer is related to the scene illuminance,  $B_{SC}$ , by:

$$B_{ph} = B_{SC} \frac{RT}{4F^2 (m + 1)^2}$$

in which: R is the average scene reflectivity, T the lens transmission factor, F the lens aperture, and m the linear magnification from scene to target.

A similar relationship holds for the red, green and blue channels of a colour camera, but in this case the situation is complicated by the extra components that must be included in the optical system.

## 2.2 Radiant sensitivity and spectral response

The *radiant sensitivity*,  $S_r$ , of a camera tube is the average signal current generated per unit radiant energy falling uniformly on the scanned area of its target. Radiant energy is commonly expressed in mA/W, and at a given wavelength  $\lambda$  it is related to the *luminous sensitivity*,  $S_L$  by:

$$S_r(\lambda) = 0,680 V(\lambda) S_L(\lambda)$$

in which  $V(\lambda)$  is the normalized spectral sensitivity of the eye at wavelength  $\lambda$ . Note:  $V(\lambda)$  is an empirical function that has been internationally agreed; its peak value is unity which occurs at a wavelength of 555 nm.

The radiant sensitivity of a camera tube varies with wavelength. The *spectral response curves* given in Fig. 5 show this variation for some typical camera tubes; these curves are merely exemplary, and for spectral response details of specific tubes the relevant data sheet should be consulted.

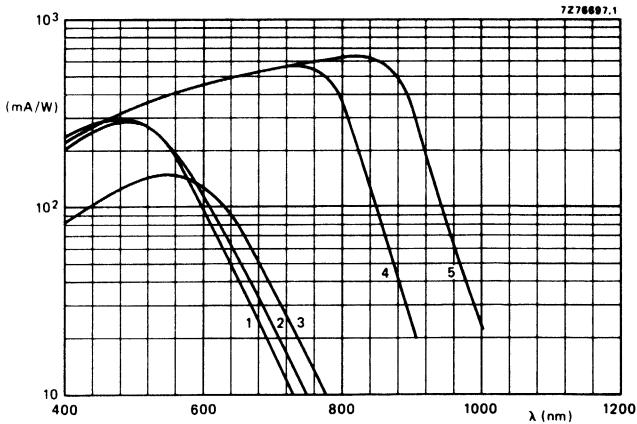

Fig. 5 Spectral response of various camera tubes. (1) Plumbicon tube XQ1073; (2)  $Sb_2S_3$  vidicon XQ1280; (3)  $Sb_2S_3$  vidicon XQ1240; (4) Newvicon tube XQ1274; (5) Newvicon tube XQ1276.

### 2.3 Resolution

The resolution of a camera tube is commonly expressed in terms of its *modulation depth*, which is defined as the ratio (expressed as a percentage) of the amplitudes of a 5 MHz and a 0,5 MHz square-wave signal as measured on a waveform monitor.

The square-wave signal can be produced by a test pattern comprising vertical black and white bars of equal thickness. The pattern may be specified in terms of the video frequency, or in terms of the corresponding number of TV lines, i.e. the number of bars that will fill a TV picture when arranged horizontally. For the CCIR system (52  $\mu$ s scan), 5 MHz corresponds to about 530 vertical bars or 400 TV lines, and 0,5 MHz corresponds to about 40 TV lines.

A pattern can also be specified by the number of line-pairs per mm (lp/mm), a line-pair being an adjacent pair of black and white bars. 400 TV lines corresponds to:

- 12,5 lp/mm for a 30 mm tube with enlarged scanning (scanned area 15,6 mm x 20,8 mm);
- 15,6 lp/mm for a 30 mm tube (scanned area 12,8 mm x 17,1 mm);
- 20,8 lp/mm for a 25 mm tube (scanned area 9,6 mm x 12,8 mm);
- 30,3 lp/mm for a 18 mm tube (scanned area 6,6 mm x 8,8 mm);
- 40,6 lp/mm for a 14 mm tube (scanned area 4,8 mm x 6,4 mm).

The modulation depth values given in this handbook include the slight degradation produced by the camera lens. For the purpose of these measurements, a lens aperture of 5,6 is taken.

### 2.4 Lag

In a camera tube there is always a delay in establishing a new signal current following a rapid change in target illumination. This is the phenomenon of *lag*. Two types of lag occur in a photoconductive camera tube: *photoconductive lag* determined principally by the nature of the target, and *discharge (or capacitive) lag* attributed to the way in which the electron beam discharges the target.

We define two forms of lag for measurement purposes:

- *decay lag* occurring at the transition from light to dark. This is measured after the target has been illuminated for at least 5 s, and is usually given as the ratio (expressed as a percentage) of the residual signal current to the initial current, the residual current being measured 60 ms and 200 ms (at 50 Hz) after the light is cut off.
- *build-up lag* occurring at the transition from dark to light. This is measured after 10 s of darkness, and is given as the ratio (expressed as a percentage) of the intermediate signal current to the final current, the intermediate current being measured 60 ms and 200 ms (at 50 Hz) after restoring the light.

## 3 Camera tube types

### 3.1 Plumbicon tube - lead oxide photoconductive layer

The photoconductive layer forms a continuous array of reverse-biased PIN-diodes, giving it an extremely low dark current. Its linear transfer characteristic, high sensitivity, very low photoconductive lag, excellent resolution and low burn-in make it pre-eminently suited to colour TV. Lead oxide does not respond to wavelengths greater than about 650 nm, but a small amount of sulphur included in the layer extends its response to wavelengths in the deep red (*extended red* Plumbicon tubes).

N.B. Plumbicon tubes do not permit automatic sensitivity control by means of regulation of the signal electrode voltage. Adequate control is therefore to be achieved by other means (iris control and neutral density filters).

When the tube is to be applied in a camera originally designed for vidicons, the automatic sensitivity control circuitry should, to prevent permanent damage or destruction of the target, be made inoperative and the signal electrode voltage be set to 45 V.

### 3.2 Vidicon tube - antimony trisulphide ( $\text{Sb}_2\text{S}_3$ ) photoconductive layer

The sensitivity of an  $\text{Sb}_2\text{S}_3$  layer depends on the target voltage (the voltage across the layer), so it is possible to control the sensitivity by varying this voltage. The dark current is strongly dependent upon target voltage as well as upon temperature.

The  $\text{Sb}_2\text{S}_3$  layer suffers from photoconductive lag and is prone to burn-in. The layer also has a non-linear transfer characteristic and so is less suited to colour TV. However, since the layer is thin its resolution is high.

Standard vidicons are relatively inexpensive to manufacture, so despite their drawbacks they are used extensively in less critical applications. Variants of the standard vidicon have been developed for use in medical X-ray equipment where they are coupled to an X-ray image intensifier.

### 3.3 Newwicon tube - heterojunction photoconductive layer

The photoconductive layer contains sublayers of zinc selenide ( $\text{ZnSe}$ ) and of a zinc telluride ( $\text{ZnTe}$ ) cadmium telluride ( $\text{CdTe}$ ) mixture. In operation the layer is reverse-biased. The layer produces a non-negligible dark current that is temperature dependent.

The Newwicon tube has very high sensitivity which extends into the near infrared. It is not possible to adjust this sensitivity by varying the target voltage. The tube has a linear transfer characteristic and low burn-in. Its photoconductive layer is thin, so it has high lag and and high resolution.

## 4 Equipment design and operating conditions

### 4.1 Signal electrode connection

The signal electrode connection should be made by a spring contact that bears against the target connection. The spring contact may be part of the coil assembly.

### 4.2 Deflection circuitry

The signal current is a function of target illumination and of scanning speed. The deflection circuitry must therefore provide constant scanning speed to ensure that the variation in signal current is a true representation of the intensity profile across the target.

### 4.3 Electrostatic shielding

To avoid interference in the picture the signal electrode must be electrostatically shielded, e.g. by one grounded shield inside the focusing coil at the faceplate end, and one inside the deflection yoke.

### 4.4 Polarity of focusing coil

The polarity of the focusing coil should be such that the target end will attract (for 30 mm tubes, repel) a north seeking pole.

### 4.5 Full size scanning

The full scanning area should always be covered during scan; underscanning of the photoconductive layer or failure to scan, even for a short time, can cause permanent damage.

To prevent the electron beam landing on the target during vertical and horizontal flyback (which would remove some picture information from the target), a blanking pulse must be applied - either a negative pulse to the control grid or a positive pulse to the cathode.

In tubes with a separate mesh construction corner resolution can be improved by applying suitable pulses to grid 3 (*dynamic focusing* or *focus modulation*).

The resolution of most types of photoconductive camera tube increases with increasing voltage on grids 3 and 4. High voltage operation, however, requires increased power for the deflection and focusing coils.

## RECOMMENDATIONS

- When the tube is used in a series heater chain, the heater voltage must not exceed 9,5 V (r.m.s.) when the supply is switched on. Preferably, each heater should be shunted by a zener diode.
- If cathode-current stabilization is used to stabilize beam current, the cathode heater should be arranged to operate for at least 1 minute before any beam current is drawn.

## CAUTION

Camera tubes with photoconductive layers contain toxic compounds. Dispose of them with care. If a tube is broken, take suitable precautions in collecting and disposing of fragments. Avoid direct contact or inhalation of particles.

# RATING SYSTEM

(in accordance with IEC Publication 134)

## ABSOLUTE MAXIMUM RATING SYSTEM

Absolute maximum ratings are limiting values of operating and environmental conditions applicable to any electronic device of a specified type as defined by its published data, which should not be exceeded under the worst probable conditions.

These values are chosen by the device manufacturer to provide acceptable serviceability of the device, taking no responsibility for equipment variations, environmental variations, and the effects of changes in operating conditions due to variations in the characteristics of the device under consideration and of all other electronic devices in the equipment.

The equipment manufacturer should design so that, initially and throughout life, no absolute maximum value for the intended service is exceeded with any device under the worst probable operating conditions with respect to supply variation, equipment component variation, equipment control adjustment, load variations, signal variation, environmental conditions, and variations in characteristics of the device under consideration and of all other electronic devices in the equipment.

## CLASSIFICATION

The devices are classified as follows:

**N = New type.** Recommended for new equipment design. Data is derived from development samples, made available for evaluation. It does not necessarily imply that the device will go into regular production.

**D = Design type.** Recommended for equipment design; production quantities available at date of publication.

**C = Current type.** No longer recommended for equipment design; available for equipment production and for use in existing equipment.

**M = Maintenance type.** No longer recommended for equipment production; available for maintenance of existing equipment.

**O = Obsolescent type.** Available until present stocks are exhausted.

Obsolescent types of which all stocks are exhausted are called **obsolete**; any data still published on these types is for reference purposes only.

The status of all types is given in the Survey of Plumbicon tubes together with data in condensed form.

## SURVEY OF PLUMBICON® TUBES

Abbreviations used in the tables:

● **Photoconductive layer**

|       |  |                  |
|-------|--|------------------|
| SR    | = standard resolution  | cut-off ≈ 650 nm |
| HR    | = high resolution  | cut-off ≈ 650 nm |
| ER    | = with extended red response, high resolution  | cut-off ≈ 900 nm |
| ER(F) | = with extended red response, high resolution and IR reflecting filter on anti-halation glass disc | cut-off ≈ 750 nm |

● **Quality grade**

|     |              |
|-----|--------------|
| Br  | = broadcast  |
| Ind | = industrial |
| Med | = medical    |

Industrial grade (IG) versions of all tube types with broadcast quality are also available. IG types are electrically and mechanically identical to the broadcast quality types, the only difference being the degree of freedom from blemishes on the photoconductive target.

The type number of IG tubes is established by using the first three digits of the corresponding broadcast quality type, followed by a digit which is one higher than that of the broadcast type, e.g.:

|                        |                 |
|------------------------|-----------------|
| broadcast type XQ1020, | IG type: XQ1021 |
| XQ1427                 | XQ1428          |
| XQ1505                 | XQ1506          |
| XQ1523                 | XQ1524          |

● **Applications**

|     |   |
|-----|---|
| B/W | = for black and white cameras                                 |
| L   | = for luminance channel                                       |
| R   | = for red chrominance channel                                 |
| G   | = for green chrominance channel                               |
| B   | = for blue chrominance channel                                |
| Med | = medical; coupled to X-ray image intensifier                 |
| Sc  | = scientific, surveillance; coupled e.g. to image intensifier |

● **Notes** (see tables on following pages)

1. Without anti-halation glass disc.
2. With infrared reflecting filter on anti-halation glass disc.
3. Without anti-halation glass disc: add suffix/01 to type number.
4. Add suffix/02 for rear loading type, with provisions for adjustable light bias.
5. Add suffix/03 for front loading type, with provisions for adjustable light bias.
6. Add suffix/05 for rear loading type, without provisions for adjustable light bias.

**PLUMBICON TUBES - 30 mm (1¼ inch)**

Maintenance types 300 mA; (including adapter)  
6,3 V

| type         | photo-conductive layer | quality grade  |     |     |     |   | applications |   |   |     |   | notes |
|--------------|------------------------|--|-----|-----|-----|---|--------------|---|---|-----|---|-------|
|              |                        | Br   | Ind | Med | B/W | L | R            | G | B | Med |   |       |
| XQ1020       | SR                     | ●  |     |     | ●   | ● | ●            | ● | ● | ●   |   |       |
| XQ1021       | SR                     |  | ●   |     | ●   |   | ●            | ● | ● |     |   |       |
| XQ1022       | SR                     |  |     | ●   |     |   |              |   |   |     | ● | 1     |
| XQ1023       | ER                     | ●  |     |     |     |   |              |   | ● |     |   |       |
| XQ1024       | ER                     |  | ●   |     |     |   |              |   | ● |     |   |       |
| XQ1025       | ER(F)                  | ●  |     |     | ●   | ● | ●            |   |   |     |   | 2     |
| XQ1026       | ER(F)                  |  | ●   |     | ●   | ● | ●            |   |   |     |   | 2     |
| Design types | 190 mA;<br>6,3 V       | <input type="checkbox"/> provision for both fixed and adjustable light bias<br><input type="checkbox"/> high resolution  |     |     |     |   |              |   |   |     |   |       |
| XQ1410       | HR                     | ●  |     |     | ●   | ● | ●            | ● | ● |     |   |       |
| XQ1413       | ER                     | ●  |     |     |     |   |              |   | ● |     |   |       |
| XQ1415       | ER(F)                  | ●  |     |     | ●   | ● | ●            |   |   |     |   | 2     |
| Design types | 190 mA;<br>6,3 V       | <input type="checkbox"/> anti-comet-tail electron gun (ACT)<br><input type="checkbox"/> provision for both fixed and adjustable light bias<br><input type="checkbox"/> high resolution |     |     |     |   |              |   |   |     |   |       |
| XQ1520       | HR                     | ●  |     |     | ●   | ● | ●            | ● | ● |     |   |       |
| XQ1523       | ER                     | ●  |     |     |     |   |              |   | ● |     |   |       |
| XQ1525       | ER(F)                  | ●  |     |     |     |   |              |   | ● | ●   |   | 2     |
| New types    | 190 mA;<br>6,3 V       | <input type="checkbox"/> high resolution; "diode" electron gun (DBC)<br><input type="checkbox"/> provision for both fixed and adjustable light bias                                    |     |     |     |   |              |   |   |     |   |       |
| XQ3440       | HR                     | ●  |     |     | ●   | ● | ●            | ● | ● |     |   |       |
| XQ3443       | ER                     | ●  |     |     |     |   |              |   | ● |     |   |       |
| XQ3445       | ER(F)                  | ●  |     |     |     |   |              |   | ● |     |   | 2     |
| Design type  | 190 mA;<br>6,3 V       | <input type="checkbox"/> high resolution; "diode" electron gun (DBC)<br><input type="checkbox"/> enlarged scanning area  |     |     |     |   |              |   |   |     |   |       |
| XQ4502       | ER                     |  | ●   |     |     |   |              |   |   |     | ● |       |

Notes on page 12.

# GENERAL

## PLUMBICON TUBES - 25 mm (1 inch)

Maintenance types 95 mA;  
6,3 V

○ front and rear loading types, with or without provision for adjustable light bias

| type   | photo-conductive layer | quality grade |     |     |     |   | applications |   |   |     |   | notes   |
|--------|------------------------|---------------|-----|-----|-----|---|--------------|---|---|-----|---|---------|
|        |                        | Br            | Ind | Med | B/W | L | R            | G | B | Med |   |         |
| XQ1070 | SR                     | ●             |     |     | ●   | ● | ●            | ● | ● |     |   | 3, 4, 5 |
| XQ1071 | SR                     |               | ●   |     | ●   |   | ●            | ● | ● |     |   | 3, 4, 5 |
| XQ1072 | SR                     |               |     | ●   |     |   |              |   |   |     | ● | 1       |
| XQ1073 | ER                     | ●             |     |     |     |   |              | ● |   |     | ● | 3, 4, 5 |
| XQ1074 | ER                     |               | ●   |     |     |   |              | ● |   |     |   | 3, 4, 5 |
| XQ1075 | ER(F)                  | ●             |     |     | ●   |   |              | ● |   |     |   | 2, 4, 5 |
| XQ1076 | ER(F)                  |               | ●   |     | ●   |   |              | ● |   |     |   | 2, 4, 5 |

Maintenance types 95 mA;  
6,3 V

○ anti-comet-tail electron gun  
○ provision for adjustable light bias

|               |       |   |  |  |   |   |   |   |   |  |  |   |
|---------------|-------|---|--|--|---|---|---|---|---|--|--|---|
| XQ1080 XQ1090 | SR    | ● |  |  | ● | ● | ● | ● | ● |  |  |   |
| XQ1083 XQ1093 | ER    | ● |  |  |   |   |   | ● |   |  |  |   |
| XQ1085 XQ1095 | ER(F) | ● |  |  |   |   |   | ● |   |  |  | 2 |

Design types 190 mA;  
6,3 V

○ high resolution, anti-comet-tail electron gun  
○ provision for adjustable light bias

|               |       |   |  |  |   |   |   |   |   |  |  |   |
|---------------|-------|---|--|--|---|---|---|---|---|--|--|---|
| XQ1500 XQ1510 | HR    | ● |  |  | ● | ● | ● | ● | ● |  |  |   |
| XQ1503 XQ1513 | ER    | ● |  |  |   |   |   | ● |   |  |  |   |
| XQ1505 XQ1515 | ER(F) | ● |  |  |   |   |   | ● |   |  |  | 2 |

Current types 95 mA;  
6,3 V

○ high resolution, "diode" electron gun (DBC)  
○ provision for adjustable light bias

|        |       |   |  |  |   |   |   |   |   |  |   |            |
|--------|-------|---|--|--|---|---|---|---|---|--|---|------------|
| XQ2070 | HR    | ● |  |  | ● | ● | ● | ● | ● |  |   | 4, 5, 6    |
| XQ2073 | ER    | ● |  |  |   |   |   | ● |   |  | ● | 4, 5, 6    |
| XQ2075 | ER(F) | ● |  |  |   |   |   | ● |   |  |   | 2, 4, 5, 6 |

Design type 190 mA;  
6,3 V

○ high resolution, "diode" electron gun (DBC)  
○ provision for adjustable light bias

|        |  |  |  |  |   |  |  |  |  |  |   |      |
|--------|--|--|--|--|---|--|--|--|--|--|---|------|
| XQ2172 |  |  |  |  | ● |  |  |  |  |  | ● | 4, 5 |
|--------|--|--|--|--|---|--|--|--|--|--|---|------|

Design types 95 mA;  
6,3 V

○ high resolution, "diode" gun (DBC)  
○ provision for adjustable light bias  
○ low output capacitance (LOC)

|        |       |   |  |  |   |   |   |   |   |  |  |         |
|--------|-------|---|--|--|---|---|---|---|---|--|--|---------|
| XQ3070 | HR    | ● |  |  | ● | ● | ● | ● | ● |  |  | 4, 6    |
| XQ3073 | ER    | ● |  |  |   |   |   | ● |   |  |  | 4, 6    |
| XQ3075 | ER(F) | ● |  |  |   |   |   | ● |   |  |  | 2, 4, 6 |

Notes on page 12.



**PLUMBICON TUBES - 18 mm (2/3 inch)**

| Design types  | 95 mA;<br>6,3 V        |   |              |
|---------------|------------------------|---|--------------|
| type          | photo-conductive layer | quality grade   | applications |
|               |                        | Br Ind Med B/W L R G B  |              |
| XQ1427        | ER                     | ● ● ● ● ● ● ● ●   |              |
| XQ1428        | SR                     | ● ● ● ● ● ● ● ●   |              |
|               | ER                     | ● ● ● ● ● ● ● ●   |              |
|               | SR                     | ● ● ● ● ● ● ● ●   |              |
| Current types | 95 mA;<br>6,3 V        | ○ high resolution, "diode" electrode gun (DBC)  |              |
| XQ2427        | ER                     | ● ● ● ● ● ● ● ●   |              |
| XQ2428        | HR                     | ● ● ● ● ● ● ● ●   |              |
|               | ER                     | ● ● ● ● ● ● ● ●   |              |
|               | HR                     | ● ● ● ● ● ● ● ●   |              |
| Design types  | 95 mA;<br>6,3 V        | ○ high resolution, "diode" electrode gun (DBC)<br>○ low output capacitance (LOC)  |              |
| XQ3427        | ER                     | ● ● ● ● ● ● ● ●   |              |
| XQ3428        | HR                     | ● ● ● ● ● ● ● ●   |              |
|               | ER                     | ● ● ● ● ● ● ● ●   |              |
|               | HR                     | ● ● ● ● ● ● ● ●   |              |
| Design type   | 95 mA;<br>6,3 V        | ○ high resolution, "diode" electron gun (DBC)<br>○ low output capacitance (LOC)<br>○ magnetic focusing, electrostatic deflection (MS) |              |
| XQ3457        | ER                     | ● ● ● ● ● ● ● ●   |              |
|               | HR                     | ● ● ● ● ● ● ● ●   |              |
| Design type   | 95 mA;<br>6,3 V        | ○ electrostatic focusing  |              |
| XQ3467        | SR                     | ● ● ● ● ● ● ● ●   |              |
|               | ER                     | ● ● ● ● ● ● ● ●   |              |
| New type      | 55 mA;<br>9 V          | ○ high resolution, "HS diode" electron gun (DBC)<br>○ low output capacitance (LOC)<br>○ electrostatic focusing                        |              |
| XQ4187        | HR                     | ● ● ● ● ● ● ● ●   |              |
|               | ER                     | ● ● ● ● ● ● ● ●   |              |

# GENERAL

## PLUMBICON TUBES - 14 mm (1/2 inch)

|              |               |   |
|--------------|---------------|---|
| Design types | 55 mA;<br>9 V | <input type="checkbox"/> high resolution, "HS diode" electron gun (DBC)<br><input type="checkbox"/> low output capacitance (LOC)<br><input type="checkbox"/> electrostatic focusing |
|--------------|---------------|---|

| type   | photo-<br>conductive<br>layer | quality grade applications |     |     |     |   |   |   |   |
|--------|-------------------------------|----------------------------|-----|-----|-----|---|---|---|---|
|        |                               | Br                         | Ind | Med | B/W | L | R | G | B |
| XQ4087 | HR<br>ER                      |                            |     |     |     |   |   | ● | ● |
|        |                               |                            |     |     |     |   |   | ● | ● |

Accessories for Plumbicon tubes

|                  |                | 30 mm (1¼") dia. all magnetic |                | 30 mm (1¼") dia. enlarged scan all magnetic |   | 25 mm (1") dia. all magnetic |                         |                    |            |                    |                    |                    |
|------------------|----------------|-------------------------------|----------------|---|---|------------------------------|-------------------------|--------------------|------------|--------------------|--------------------|--------------------|
|                  | light bias     | ACT and LOC light bias        |                | DBC LOC                                     | front loading   | /02 versions light bias      | /03 versions light bias | ACT and light bias |            | ACT and light bias | DBC light bias LOC | DBC and light bias |
|                  |                | light bias                    | light bias     |   |   |                              |                         | light bias         | light bias |                    |                    |                    |
| example          | XQ1410         | XQ1520                        | XQ3440         | XQ4502                                      |   | XQ1070/02                    | XQ1070/03               | XQ1080             | XQ1090     | XQ3070/02          | XQ2070/03          |                    |
| coil unit colour | AT1130S        |                               |                | AT1107                                      | AT1116S (front loading)<br>AT1119/01 (rear loading)     |                              |                         |                    |            |                    |                    |                    |
| coil unit colour | AT1130/..*     |                               |                |   | AT1116/..* (front loading)<br>AT1126/..* (rear loading) |                              |                         |                    |            |                    |                    |                    |
| socket           | 56021<br>56025 | 56025                         | 56021<br>56025 | 56021                                       |   | 56098                        |                         | 56026              |            | 56098              |                    |                    |
| light bias lamp  | 56106          |                               |                |   |   | 56106                        |                         | 56027              |            | 56106              |                    |                    |
| adapters**       | R              | 56123                         |                |   |   |                              |                         |                    |            |                    |                    |                    |
| G                |                | 56124                         |                |   |   |                              |                         |                    |            |                    |                    |                    |
| B                |                | 56125                         |                |   |   |                              |                         |                    |            |                    |                    |                    |
|                  |                | 56126▲                        |                |   |   |                              |                         |                    |            |                    |                    |                    |
|                  |                | 56139▲▲                       |                |   |   |                              |                         |                    |            |                    |                    |                    |
| mask             | 56029          |                               |                |   |   |                              |                         | 56028              |            |                    |                    |                    |

\* Computer selected triplet, various versions.  
 \*\* Adapters for fixed light bias for XQ1410 series and XQ1520.  
 ▲ Adapter for adjustable light bias for XQ1410 series for use in Marconi Mark VIII camera (variant).  
 ▲▲ Adapter for fixed light bias for XQ1410 series for use in RCA TK47 camera.

Accessories for Plumbicon tubes (continued)

|                  | 18 mm (2/3") dia. all magnetic |            | 18 mm (2/3") dia. MS |            | 18 mm (2/3") dia. electrostatic focusing |         | 14 mm (1/2") dia. electrostatic focusing |  |
|------------------|--------------------------------|------------|----------------------|------------|--|---------|--|--|
|                  | DBC                            | DBC<br>LOC | DBC<br>LOC           |            | HS<br>DBC<br>LOC                         |         | HS<br>DBC<br>LOC                         |  |
|                  | rear loading                   |            | front loading        |            | front loading                            |         | front loading                            |  |
| example          | XQ2427                         | XQ3427     | XQ3457               | XQ3467     | XQ4187                                   | XQ4087  |  |  |
| coil unit B/W    | AT1109/01S                     |            | KV4722               | KV4780     | KV4736AS                                 | AT1120S |  |  |
| coil unit colour | AT1109/.*                      | AT1109/.*  | 3 x KV4722           | 3 x KV4780 | KV4736AT*                                | AT1120T |  |  |
| socket           | 56049                          |            | 56601                | 56604      | -  | -       |  |  |
| light bias lamp  | -                              | -          | -                    | -          | -  | -       |  |  |
| mask             | 56033                          | 56030      | -                    | 56033      | 56030                                    | -       |  |  |

\* Computer selected triplet, various versions.

## GENERAL OPERATIONAL NOTES

### 1 Properties of the lead oxide photoconductive layer

The Plumbicon tube has a lead oxide photoconductive layer. In tubes with extended red response a small amount of sulphur is added to the lead oxide.

#### 1.1 Sensitivity

Since the Plumbicon tube has a linear light transfer characteristic, its sensitivity can be specified completely by the number of  $\mu\text{A}/\text{lumen}$  delivered to the signal electrode. A typical value for a standard layer (without extended red response) in tungsten light with a colour temperature of 2856 K would be 400  $\mu\text{A}/\text{lumen}$  (d.c. value).

Sensitivity increases with target voltage, but at the recommended voltage (45 V) it is almost at maximum and rises only slightly with further voltage increases.

For a given target illumination, the signal current is a function of the scanned area; but it can be shown that in the Plumbicon tube with its linear light transfer characteristic, camera sensitivity is independent of tube size for the same depth of field and viewing angle.

#### 1.2 Spectral response

Figure 1 shows typical spectral response curves of some 30 mm Plumbicon tubes. Curve 1 relates to the high resolution layer used, for example, in the XQ1410; curve 2 relates to the extended-red layer as used in the XQ1413.

Because the sensitivity of the XQ1413 is high in the deep red region, an infrared reflecting filter should be used for proper colour rendition. The XQ1415, whose spectral response is given by curve 3, already has such a filter provided with the anti-halation disc cemented to its faceplate (see 1.5 below).

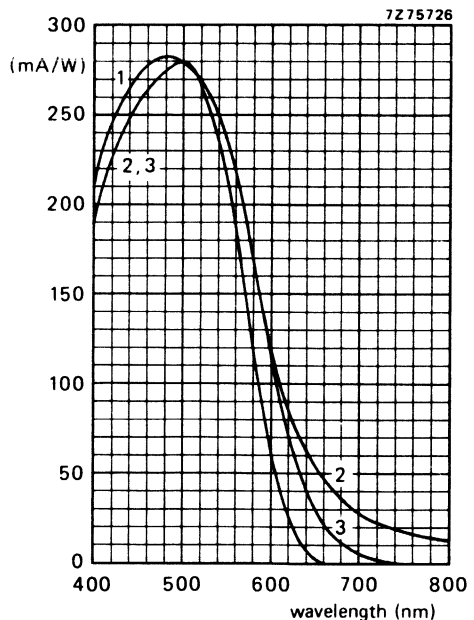

Fig. 1 Typical spectral response curves of 30 mm Plumbicon tubes.

1-inch Plumbicon tubes with extended red sensitivity, such as the XQ1073 and the XQ1083, have somewhat lower red and deep red sensitivities due to a smaller amount of sulphur in the photoconductive layer. For correction of the colour response therefore less filtering is needed. The Plumbicon tube types XQ1075 and XQ1085 are provided with the appropriate infrared reflecting filter.

1.3 Resolution

The resolution of the extended-red layer is higher than that of the standard layer, which is used, for example, in the XQ1020. A high resolution layer without extended-red response has been developed, which closely approaches the resolution of the extended-red layer.

Figure 2 shows typical modulation transfer characteristics of some Plumbicon tubes, measured in green light, as a function of the number of line pairs per mm.

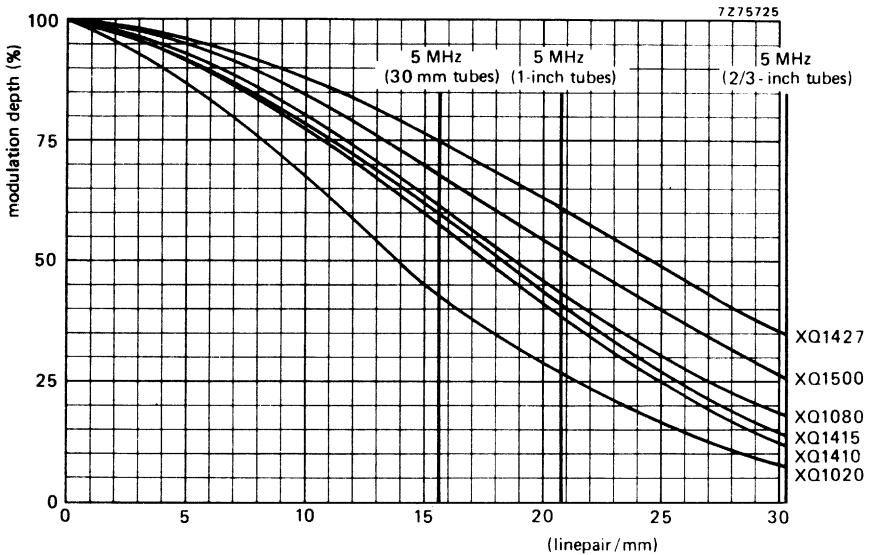

Fig. 2 Typical square-wave modulation transfer curves of some Plumbicon tubes.

The vertical lines in the figure correspond to 400 TV lines for 30 mm (15,6 lp/mm), 1-inch (20,8 lp/mm) and 2/3-inch (30,3 lp/mm) tubes. It can be seen that at 400 TV lines (5 MHz) resolution increases with increasing tube size (increased scanning area). For a given number of line pairs per mm the smallest tube has the highest resolution.

The XQ1020 has a standard layer, the XQ1415 and the XQ1427 have extended-red layers the XQ1410, XQ1080 and XQ1500 have high resolution layers. Due to a special gun construction the XQ1500 has an appreciably higher resolution than the XQ1080.

1.4 Lag

The photoconductive lag of the lead oxide layer is practically negligible. Due to the fact that the photoconductive layer in the tubes is relatively thick (10 to 18  $\mu\text{m}$ , depending on tube type), Plumbicon tubes show very little discharge lag at normal signal currents.

Discharge lag becomes evident under low key conditions, when signal currents are small. This type of lag depends on layer capacitance and beam resistance. The effective beam resistance is decreased by applying light bias and thereby the discharge lag is reduced. Figure 3 shows an example of the effect of light bias on discharge lag (30 mm Plumbicon tube type XQ1410, signal current of 40 nA, green light, beam setting 600 nA).

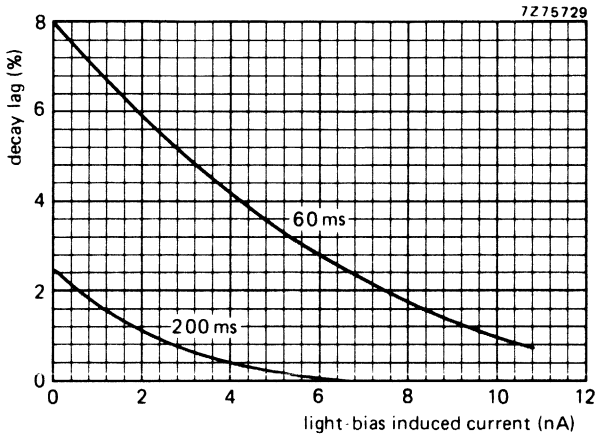

Fig. 3 Typical influence of light bias on decay lag in XQ1410.

In some types of Plumbicon tubes means are available for applying light bias on the gun side of the photoconductive layer (internal light bias). Figure 4 shows how this is achieved in the 30 mm Plumbicon tube XQ1410.

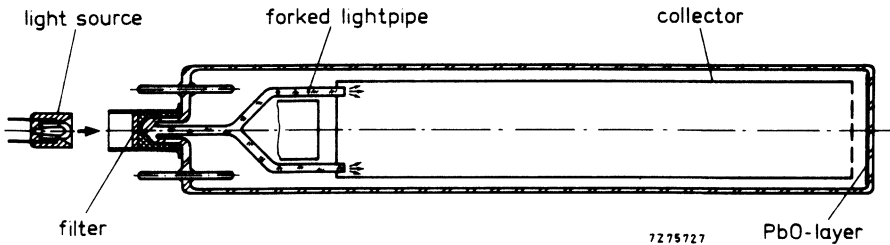

Fig. 4 Light bias in the XQ1410.

Light from a small lamp falls on the pumping stem of the tube and is conveyed by a forked glass light pipe into the collector space. It then falls directly or via reflection against the collector wall on the target. The light source (fixed or adjustable) fits in a metal sleeve fixed on the pumping stem.

## 1.4.1 Considerations

### 1.4.1.1 WITH ADJUSTABLE LIGHT BIAS (VIA PUMPING STEM)

For this purpose a light bias lamp, type 56106, is available.

#### **Amount of light bias**

##### *Black and white cameras*

The amount of light bias required in a black/white camera is not critical (see published data) and may be 3 to 5 nA(p) the upper limit being determined by the onset of objectionable black shading.

##### *Colour cameras without black shading compensation circuitry*

Depending on the type of camera and the subjective judgement of the camera engineer, the light bias should generally be set to 3 nA(p) for R, 2 nA(p) for G, and 3,5 nA(p) for B tubes respectively.

A suggested procedure is as follows:

The camera is focused onto a metronome, placed in front of a dark background, and carrying a small white square, which produces a peak output current in the green channel of, for instance, 30 nA. About 2 nA(p) of light bias is applied to the green tube by adjusting the current through its lamp. Subsequently the currents through the light bias lamps of the R and B tubes are adjusted for the best compromise with respect to build-up and decay lag aiming at non-coloured lag phenomena as observed on a colour monitor. Infrared light with a wavelength  $> 600$  nm should be avoided.

##### *Colour cameras with black shading compensation circuitry*

In colour cameras with black shading compensation still higher bias currents, and hence better lag performance, can be achieved.

### 1.4.1.2 WITH FIXED LIGHT BIAS

Also available for 30 mm tubes is an adapter for fixed light bias operation. The adapter carries a colour code in accordance with the application for which the tube is intended. The adapter is slipped over the pins of the tube before putting on the socket (see drawing) and connects a light bias lamp via a series resistor to the heater pins.

The light bias induced dark currents (at  $6,30 \pm 0,05$  V) will be approximately:

- 4,5 nA(p) for B/W tubes
- 3 nA(p) for R tubes
- 2 nA(p) for G, L tubes
- 3,5 nA(p) for B tubes

whereas an extra 95 mA (approx.) will be drawn from the heater supply.

Provided the heater voltage supply is capable of delivering a well stabilized voltage when these extra lamp currents are drawn, the tubes XQ1410, XQ1413, and XQ1415 – operated with the adapter – can be considered as plug-in replacements for standard tubes, however, with clearly improved lag (and resolution).

Optimum performance with respect to non-coloured lag phenomena is obtained only when adjustable light bias is applied.

### 1.4.1.3 WITH LIGHT BIAS (FIXED OR ADJUSTABLE) APPLIED VIA THE OPTICAL SYSTEM

Though excellent performance with respect to speed of response can be obtained it appears to be difficult to produce sufficient uniformity of the light bias induced dark currents and, in a colour camera, to adjust the light bias per tube for neutral i.e. non-coloured lag phenomena, when televising moving objects.



1.4.1.4 WITHOUT LIGHT BIAS

Acceptable performance with respect to speed of response will only be achieved with adequate scene illumination.

The envelopes of the tubes are blackened underneath the plastic base to prevent direct transfer from light bias – if this is applied to the pumping stem – through the envelope to the target, which would cause objectionable peak white shading (often referred to as ‘ears’) on the black level in the picture corners. This blackening, however, also absorbs the light emitted by the heater of the cathode, light which in tubes like XQ1020 induces some artificial dark current. This absence of heater light causes a slightly increased beam discharge lag in tubes XQ1410, XQ1413, and XQ1415.

**REMARK**

The life expectancy of the lamps used in 56106 and the adapter is, as stated by the manufacturer,  $> 2 \times 10^4$  h at full rating, i.e. 5,5 V, 110 mA, and they will therefore generally outlive the camera tubes. Spares and replacements can be supplied.

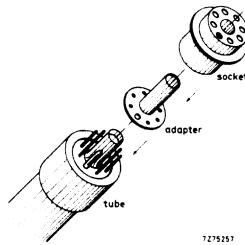

Fig. 5.

|                     |       |                 |
|---------------------|-------|-----------------|
| adapter for R tubes | 56123 | 9390 270 10XX00 |
| G, L tubes          | 56124 | 9390 270 20XX00 |
| B tubes             | 56125 | 9390 270 30XX00 |

1.4.1.5 INSTRUCTIONS FOR USE OF LIGHT BIAS LAMP TYPE 56106

Light bias lamp type 56106 is intended for use with those Plumbicon tubes that have a thin metal tube (provided with a filter) cemented to the pumping stem, e.g. XQ1410 series.

**INSTALLING THE LAMP**

Using the XQ1410 series as an example, the following installation procedure is recommended (Fig. 5).

1. Insert tube A into the deflection/focusing assembly.
2. Push lamp B firmly into the metal tube on the pumping stem.
3. Mate socket C with the base pins of the tube, allowing the lamp wires to pass through the pumping stem clearance hole in the socket.

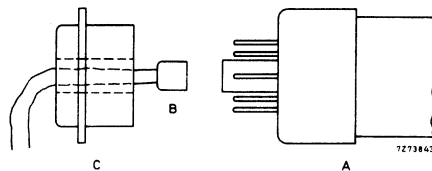

Fig. 6 Installing the light bias lamp.

**SUPPLYING THE LAMP**

**Black/white cameras**

Extreme stability is generally not needed. Lamp current can be supplied from a.c. or d.c. sources. Figure 7 shows suggested circuits.

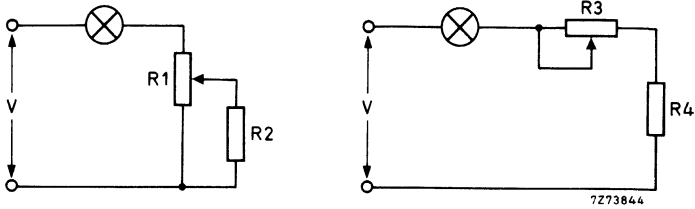

Fig. 7 Supplying the lamp in black/white cameras.

The values of R2 and R4 should limit the lamp current to its maximum value of 110 mA at 5 V. Thus:

$$\frac{R1 R2}{R1 + R2} = \frac{V - 5}{0,11} \Omega, \text{ and } R4 = \frac{V - 5}{0,11} \Omega.$$

When fully in series with the lamp, resistors R1 and R3 should decrease the lamp current to a value which causes negligible bias light, e.g. 50 mA. Thus:

$$R1_{\min} = \frac{V}{0,05} \Omega, \text{ and } R3_{\min} = \frac{V}{0,05} - R4 \Omega.$$

**Colour cameras**

A stabilized d.c. supply is preferred. In cameras with automatic black level compensation, the circuits shown in Fig. 7 may be used. For long-term stability in cameras not having black level compensation, it should be noted that the bias current, set at about 10 nA, changes by 0,5 nA when the voltage across the lamp changes by about 50 mV, and also when the current through the lamp changes by about 0,6 mA. Figure 8 shows a recommended circuit. The maximum voltage on the base of the transistor should be about 5,5 V.

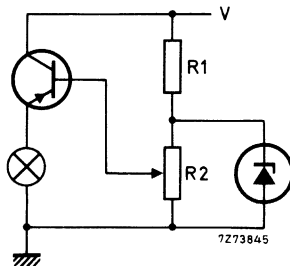

Fig. 8 Supplying the lamp in colour cameras.

**1.5 Stray light**

The reflectance of the target is not negligible. It is at its highest in the red part of the spectral range. Diffusely reflected light can be caught in the faceplate of the tube and cause stray light, 'halation'. To reduce this, an anti-halation glass disc is cemented on the faceplate, see Fig. 9.

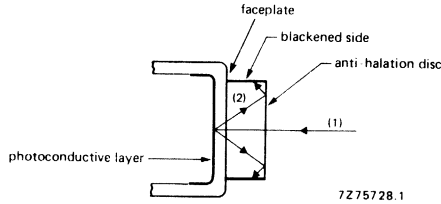

Fig. 9 Anti-halation disc on faceplate.

Further reduction of stray light can be obtained by fitting a mask on the anti-halation disc with an aperture slightly larger than the used scanning area.

**1.6 The anti-comet-tail gun**

The transfer characteristic of a Plumbicon tube is linear up to a point determined by the available beam current. This restricts its dynamic range. Local highlight levels on the target may cause blooming due to beam-bending and, in extreme cases, loss of stabilization. As it takes a number of scanlines to re-establish stabilization when an extreme highlight has moved away, 'comet tails' can occur behind a moving object.

The anti-comet-tail (ACT) gun was developed to reduce these effects. In a tube with such a gun the beam current is strongly increased during line flyback, and most of the re-charging of the target element capacitors in the areas of extreme highlight occurs in the flyback period. Figure 10 shows the principle of an ACT gun.

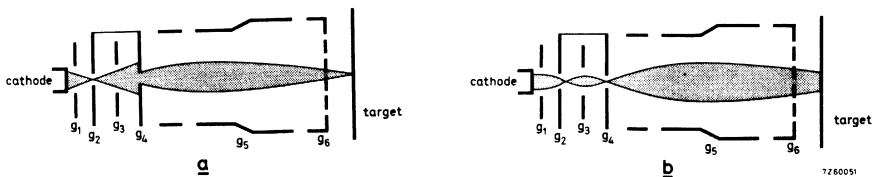

Fig. 10 Anti-comet-tail (ACT) gun; a = read-out mode; b = flyback mode.

The first anode - see Fig. 10 - has been split into two parts, the anode  $g_2$  and the limiter  $g_4$ , which are electrically connected. An additional electrode  $g_3$  has been placed between these parts. During the normal read-out scan this extra grid is maintained at a potential close to that of  $g_2$  and  $g_4$ . The scanning beam will then be in focus at the target, as shown in Fig. 10a.

During line flyback a negative-going pulse is applied to  $g_3$  to focus the scanning beam on the aperture in the limiter  $g_4$ , as shown in Fig. 10b. At the same time the beam current is strongly increased by a positive-going pulse on  $g_1$ . Thirdly, a positive-going pulse is applied to the cathode so that it is at a positive potential (e.g. +8 V) during flyback.

In this way a defocused beam carrying a large current (e.g.  $\approx 100 \mu\text{A}$ ) scans the surface of the photoconductive layer during line flyback. This beam contains sufficient current to recharge the areas of extreme highlights; it brings the surface here to cathode potential during flyback. Potential levels below this contain picture information and are not influenced. Consequently, during normal read-out, the scanning beam does not encounter target potentials higher than the cathode potential during flyback. Therefore stabilization is possible everywhere and blooming and comet-tails are strongly reduced.

**1.7 The diode gun and Dynamic Beam Control (DBC)**

In the conventional triode gun, grid 1 and the anode converge the electrons emitted by the cathode to produce a crossover in the electron beam. Electron interaction in the beam, particularly in the vicinity of the crossover, increases the differential beam resistance and so increases beam-discharge lag. In the *diode gun* grid 1 is made positive relative to the cathode. This reduces beam convergence and so eliminates the crossover. The result is reduced differential beam resistance and a larger beam reserve. The consequent reduction in lag permits the use of thinner photoconductive layers to improve resolution (particularly in smaller tubes used in portable cameras for outside broadcasts etc.).

Moreover, with the larger beam reserve of the diode gun tube, excessive highlights can be handled using *Dynamic Beam Control* (DBC). Figure 11 shows the principle of DBC. When the beam encounters a highlight, the sharp rise in signal current is detected by a feedback network which then increases the control grid voltage ( $V_{g1}$ ), so raising the beam current to read out the highlight.

N.B. Avoid continuous operation at high beam currents since this will shorten tube life.

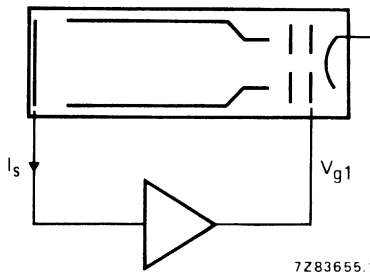

Fig. 11.

7Z83655.1

**1.8 Low output-capacitance tubes**

An important factor governing the performance of a TV camera is its signal-to-noise (S/N) ratio; the higher the S/N ratio the better the operational sensitivity of the camera. One way of increasing the S/N ratio is by reducing the total output capacitance of the tube/yoke assemblies within the camera.

In the range of low output-capacitance (LOC) Plumbicon tubes the capacitance of the tube in the deflection yoke is reduced by reducing the size on the transparent conductive film in the target.

**1.9 Burn-in or picture sticking**

The target of a Plumbicon tube has a high resistance to picture sticking but some sticking may occur at target voltages lower than specified.

### 1.10 Temperature effects

Plumbicon tubes tolerate short excursions of temperature up to 70 °C. Prolonged use at temperatures above 50 °C will, however, adversely influence tube life. It is therefore advisable to ensure that the faceplate temperature of a Plumbicon tube in a television camera does not exceed 50 °C under normal ambient temperature conditions.

## 2 RECOMMENDATIONS

2. 1 During transport, handling and storage the axis of the Plumbicon tube must be either vertical, with faceplate up, or horizontal. The faceplate should be covered with the hood provided.

2. 2 To avoid damage to the base pins, the Plumbicon tube should be inserted into its socket with care. Shocks, excessive force and bending loads on the pins are to be avoided.

2. 3 During prolonged idle periods - days or weeks - gas pressure may slowly build up in the tube due to residual gas molecules emerging from the electrodes and the glass wall. There is then a slight risk that the pressure is sufficiently high to cause cathode damage by ion bombardment if cathode current is drawn immediately after switching on the camera.

A cathode heating time of at least a minute before drawing cathode current is therefore recommended. After very long idle periods - e.g. months - it is advisable to extend this pre-heating time to 30 minutes.

2. 4 In isolated cases the properties of a Plumbicon tube may deteriorate slightly when it is kept idle for long periods such as may occur:

- between the factory's pre-shipment test and the actual delivery to the customer;
- between receipt of the tube and its installation;
- when the camera is not used for a long time.

Although the chances of such a deterioration are remote it is advisable to operate the tube for some hours at intervals not more than 4 weeks apart.

The following procedure and conditions are recommended then:

- Set grid  $g_1$ , bias control, to maximum negative bias (beam cut-off).
- Allow a heating-up time of the cathode of at least 1 minute before turning up the grid  $g_1$  control to produce a beam.
- Set scanning amplitudes to overscan condition.
- Apply an even illumination to the target to obtain a signal of approximately 0,15  $\mu\text{A}$  and adjust the beam current for correct stabilization.

2. 5 During long-term storage the ambient temperature should not exceed 30 °C.

2. 6 The light transfer characteristic of the Plumbicon tube has a gamma near unity. It may be desirable to incorporate a gamma correcting circuit in the video amplifier system with an adjustable gamma of 0,5 to 1.

2. 7 Plumbicon tubes do not permit automatic sensitivity control by means of regulation of the signal electrode voltage. Adequate control is therefore to be achieved by other means (iris control and neutral density filters).

2. 8 The beam current of a Plumbicon tube without an ACT gun is usually set at twice the value required for stabilization of normal peak white. Highlight handling is improved by using higher beam currents. Very high beam currents, however, cause increased lag, some loss of resolution, geometry shifts and reduction of tube life.

2.9 Alignment currents are used to correct for slight mechanical and electrical misalignments encountered in tubes and coil assemblies.

Alteration of alignment settings influences corner focus, geometry, beam size and registration. Poor alignment can moreover cause lag problems or a degradation of picture quality with regard to spots and blemishes.

2.10 During long standby periods, the following procedure should be adopted:

- Cap the camera lens.
- Adjust the grid 1 voltage to its maximum negative value to cut off the beam.
- Reduce the heater voltage to about 4 V.

To resume normal operation, reverse the above sequence as follows:

- Increase heater voltage to 6,3 V.
- After allowing heater to operate at 6,3 V for at least 1 minute, adjust the grid 1 voltage to restore the beam current to its required level.
- Uncap the camera lens.

# TEST SPECIFICATION FOR PLUMBICON<sup>®</sup> TUBES

(with plain glass faceplate)

## SECTION A

### Test conditions

All tests on Plumbicon tubes are carried out in the manufacturer's test channel under the following conditions:

1. *Light source:* 2856 K colour temperature (broadcast and industrial tubes);  
P20 light distribution (tubes for medical X-ray equipment).

2. *Filter:*

For chrominance tubes colour filters are inserted in the light path:

for R tubes: Schott OG570, thickness 3 mm

for G tubes: Schott VG9, thickness 1 mm

for B tubes: Schott RG12, thickness 3 mm

For tubes with extended red response but without an infrared reflecting filter on the anti-halation glass disc an additional infrared reflecting filter is inserted in the light path. The filter used is Balzers Calflex B1/K1.

For X-ray tubes: Schott VG9, thickness 1 mm

For transmission of the filters see Figs 4 and 5.

3. *Test transparency,* back-illuminated, projected onto the target by means of a high quality lens, producing an even illumination on the specified scanned area.

The test transparency has an aspect ratio of 3 : 4 for the evaluation of broadcast and industrial quality tubes. The area of the chart is divided into three quality zones by two concentric circles as shown in Fig. 1.

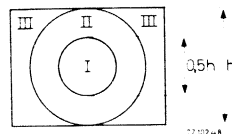

Fig. 1.

A circular test transparency is used for the evaluation of tubes for medical X-ray equipment. The area of the chart is divided into three quality zones by two concentric circles as shown in Fig. 2.

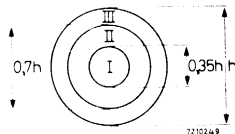

Fig. 2.

4. *The video amplifier frequency response* is essentially flat up to 5 MHz, with a sharp fall-off to 6 MHz.
5. *No gamma correction or aperture correction* are applied in the video amplifier.
6. *The light level* on the Plumbicon tube target is adjusted to produce a peak signal current  $I_s$  in accordance with Table 1.

® Registered Trade Mark for television camera tube.

7. *The electrical settings* of the tube are in accordance with its published data and the "Instructions for use".
8. *The beam current* of the Plumbicon tube is adjusted to just stabilize a peak signal current of magnitude  $I_b$  in accordance with Table 1.
9. *Monitor.* The obtained picture is observed on a monitor producing a non-blooming white.

**Table 1**  
 $I_s$  and  $I_b$   
settings

| tube diameter                  |                  | 30 mm<br>(1¼ inch)          |                  | 25 mm<br>(1 inch)                   |                  | 18 mm<br>(2/3 inch)                              |                  | 14 mm<br>(½ inch) |                  |
|--------------------------------|------------------|-----------------------------|------------------|-------------------------------------|------------------|--|------------------|-------------------|------------------|
| scanned area                   |                  | 12,8 mm x 17,1 mm           |                  | 9,6 mm x 12,8 mm                    |                  | 6,6 mm x 8,8 mm                                  |                  | 4,8 mm x 6,4 mm   |                  |
|                                |                  | $I_s$<br>$\mu A$            | $I_b$<br>$\mu A$ | $I_s$<br>$\mu A$                    | $I_b$<br>$\mu A$ | $I_s$<br>$\mu A$                                 | $I_b$<br>$\mu A$ | $I_s$<br>$\mu A$  | $I_b$<br>$\mu A$ |
| broadcast<br>quality<br>tubes  | luminance        | 0,30                        | 0,60             | 0,2                                 | 0,4              | 0,15   | 0,30             | 0,10              | 0,20             |
|                                | black & white    | 0,30                        | 0,60             | 0,2                                 | 0,4              | 0,15   | 0,30             | 0,10              | 0,20             |
|                                | red R            | 0,15                        | 0,30             | 0,1                                 | 0,2              | 0,075  | 0,15             | 0,05              | 0,10             |
|                                | green G          | 0,30                        | 0,60             | 0,2                                 | 0,4              | 0,15   | 0,30             | 0,10              | 0,20             |
|                                | blue B           | 0,15                        | 0,30             | 0,1                                 | 0,2              | 0,075  | 0,15             | 0,05              | 0,10             |
| industrial<br>quality<br>tubes | black & white    | 0,30                        | 0,60             | 0,2                                 | 0,4              | 0,15   | 0,30             | 0,10              | 0,20             |
|                                | red R            | 0,15                        | 0,30             | 0,1                                 | 0,2              | 0,075  | 0,17             | 0,05              | 0,10             |
|                                | green G          | 0,30                        | 0,60             | 0,2                                 | 0,4              | 0,15   | 0,30             | 0,10              | 0,20             |
|                                | blue B           | 0,15                        | 0,30             | 0,1                                 | 0,2              | 0,075  | 0,15             | 0,05              | 0,10             |
| X-ray<br>medical<br>tubes**    | P20 light source | scanned area*<br>18 mm dia. |                  | scanned area*<br>15 or 16,2 mm dia. |                  | tube diameter 30 mm<br>enlarged scan* 26 mm dia. |                  |                   |                  |
|                                |                  | 0,15                        | 0,30             | 0,1                                 | 0,2              | $I_s = 0,4$ $I_b = 0,8$                          |                  |                   |                  |

\* Scanning amplitude controls adjusted such that the circular quality area of the target is displayed on a standard monitor as a circular area with a diameter equal to the raster height.

\*\* For use in combination with X-ray image intensifier.

**SECTION B**

Spurious signal specification.

*Blemishes.* Both spots (sharply defined) and smudges (with vague contours) are termed blemishes. Blemishes are small areas producing uneven modulation of any signal current between black level (black current) and white level (peak signal current).



**SECTION C**

**Broadcast quality tubes**

The degrading effect caused by a blemish on the quality of the picture as observed on the monitor is expressed in its Spot Nuisance Value (S.N.V.).

The S.N.V. of a blemish is basically defined as the product of its size (measured in % of the picture height, with a special test transparency) and its contrast (or modulation depth) in % of the peak signal current produced by the circular area of the target, having a diameter of 5% of the picture height, which encircles this blemish.

The contrast is measured on a waveform oscilloscope provided with a line selector.

Tables II show which blemishes are to be neglected, because of their small size or contrast, and how the actual S.N.V. is determined per type of tube for dark and white blemishes (see also the addendum to this section).

Tables III define the maximum number of blemishes and the maximum sum of S.N.V.s per tube type, per zone, and the total which are allowed.

**Tubes with 30 mm, 25 mm diameter or 18 mm diameter**

notes

| Table II        |               | Black and white<br>Luminance L<br>Green G | Red R    | Blue B |   |
|-----------------|---------------|---|----------|--------|---|
| To be neglected | size          | ≤ 0,2%                                    | ≤ 0,2%   | ≤ 0,2% | 2 |
|                 | contrast      | ≤ 5%                                      | ≤ 8%     | ≤ 8%   |   |
| S.N.V. of       | white blemish | 2 x M.V.                                  | 1 x M.V. |        | 3 |
|                 | dark blemish  | 1 x M.V.                                  |          |        |   |
| Max. S.N.V.     | per blemish   | 20  | 20       | 20     |   |

| Table III          |  | bl/wh, L, G, R |    |     |      | B  |    |     |      |   |
|--------------------|--|----------------|----|-----|------|----|----|-----|------|---|
| Zone               |  | I              | II | III | tot. | I  | II | III | tot. |   |
| Max. number        |  | 0              | 2  | 3   | 4    | 1  | 3  | 4   | 6    |   |
| Max. sum of S.N.V. |  | 0              | 30 | 50  | 60   | 20 | 45 | 80  | 90   | 5 |

**Tubes with 14 mm diameter**

| Table II        |               | Black and white<br>Green G | Red R    | Blue B |   |
|-----------------|---------------|----------------------------|----------|--------|---|
| To be neglected | size          | ≤ 0,2%                     | ≤ 0,2%   | ≤ 0,2% | 2 |
|                 | contrast      | ≤ 6%                       | ≤ 8%     | ≤ 10%  |   |
| S.N.V. of       | white blemish | 2 x M.V.                   | 1 x M.V. |        | 3 |
|                 | dark blemish  | 1 x M.V.                   |          |        |   |
| Max. S.N.V.     | per blemish   | 20                         | 20       | 20     |   |

Notes see next page.

Table III

| Zone               | Black and white<br>Green G |    |     |      | Red R |    |     |      | Blue B |    |     |      |
|--------------------|----------------------------|----|-----|------|-------|----|-----|------|--------|----|-----|------|
|                    | I                          | II | III | tot. | I     | II | III | tot. | I      | II | III | tot. |
| Max. number        | 1                          | 2  | 3   | 4    | 1     | 3  | 4   | 6    | 2      | 4  | 6   | 8    |
| Max. sum of S.N.V. | 10                         | 30 | 50  | 60   | 15    | 45 | 80  | 100  | 20     | 50 | 90  | 110  |

notes  
4

5

**ADDENDUM**

Black blemishes with a white surrounding and white blemishes with a black core. On the oscilloscope the general shape of such a blemish will be as shown in Fig. 3.

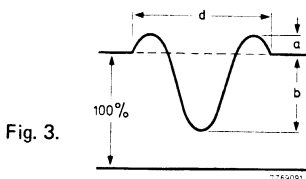

Fig. 3.

A blemish shall be considered to be a white blemish if  $a \geq b$  (S.N.V. =  $a \times d$  or  $2 \times a \times d$  in accordance with Table II) or a black blemish if  $b > a$  (S.N.V. =  $b \times d$ ).

**Notes**

1. No blemishes  $> 0,2\%$  shall be visible when the lens is capped.
2. Blemishes of this size are not counted unless their concentration causes a smudged appearance. Such concentrations are evaluated as blemishes and as contrast, the average contrast of the concentration is taken.
3. M.V. = measured value (size x contrast).
4. The minimum distance as measured in any direction between any two blemishes with S.N.V.  $\geq 10$  shall be 5% of picture height.
5. Arithmetic sum individual S.N.V.s.

**SECTION D**

notes

**Industrial quality tubes**

1

Number, size, and location of blemishes allowed.

| Dimensions of blemishes<br>in % of picture height | Permitted number of blemishes |         |          |       |   |
|---|-------------------------------|---------|----------|-------|---|
|   | Zone I                        | Zone II | Zone III | Total |   |
| ≤ 2% but > 1%                                     | 0                             | 1       | 2        | 2     | 2 |
| ≤ 1% but > 0,7%                                   |                               |         |          |       |   |
| ≤ 0,7% but > 0,45%                                | 1                             | 2       | 4        | 4     |   |
| ≤ 0,45% but > 0,2%                                | 2                             | 4       | 6        | 6     |   |
| ≤ 0,2%  |                               |         |          |       | 3 |
| Total permitted number<br>of blemishes            | 2                             | 4       | 6        | 6     | 4 |

**Notes**

1. Blemishes with contrast ≤ 10% shall not be counted.
2. Blemishes of these dimensions are not allowed when their contrast exceeds 20%.
3. Blemishes of this size are not counted unless their concentration causes a smudged appearance. Such concentrations are evaluated as blemishes and as contrast, the average contrast of the concentration is taken.
4. The distance between any two blemishes with dimensions > 0,45% shall be greater than 5% of picture height as measured in any direction.

**SECTION E**

**Tubes for medical X-ray equipment**

1

Number, size, and location of blemishes allowed.

| Dimensions of blemishes<br>in % of picture height | Permitted number of blemishes |         |          |   |
|---|-------------------------------|---------|----------|---|
|   | Zone I                        | Zone II | Zone III |   |
| > 0,7%  | 0                             | 0       | 0        |   |
| ≤ 0,7% but > 0,45%                                | 0                             | 1       | 3        |   |
| ≤ 0,45% but > 0,2%                                | 2                             | 3       | 6        |   |
| ≤ 0,2%  |                               |         |          | 2 |
| Total permitted number<br>of blemishes            | 2                             | 6       |          |   |

**Notes**

1. Blemishes with contrast ≤ 6% (if black) and ≤ 3% (if white) are neglected.
2. Blemishes of this size are not counted unless their concentration causes a smudged appearance. Such concentrations are evaluated as blemishes and as contrast, the average contrast of the concentration is taken.

## SECTION F

### Sensitivity

The luminous sensitivity is measured under the following conditions:

Light source: colour temperature 2856 K.

Filter: Appropriate filter inserted in the light path.

The illuminance level of the white light at the faceplate or for chrominance tubes before the filter is adjusted to 4,54 lx.

For 30 mm tubes the luminous flux at the scanned area on the faceplate or before the filter is now 1 mlm. In this case the measured signal current in nA gives directly the sensitivity in  $\mu\text{A}/\text{lm}(F)$ .

For 30 mm tubes with enlarged scanning the signal current readings should be multiplied by 0,67 to give the sensitivity in  $\mu\text{A}/\text{lm}(F)$ .

For 25 mm tubes the signal current reading should be multiplied by 1,8.

For 18 mm tubes the signal current reading should be multiplied by 3,8.

For 14 mm tubes the signal current reading should be multiplied by 7,1.

## SECTION G

### Resolution

Resolution is measured with a 50 mm Leitz Summicron lens having a sine response of approximately:

85% at 400 TV lines at  $f : 5,6$  for 30 mm and 25 mm tubes;

80% at 400 TV lines at  $f : 5,6$  for 18 mm tubes;

80% at 320 TV lines at  $f : 5,6$  for 14 mm tubes.

The resolution is measured with the appropriate colour filter inserted in the light path as described in section A. However, for 18 mm and 14 mm tubes a BG12 filter with a thickness of 1 mm is used for the blue tubes.

The beam current and signal current are to be adjusted as indicated in the relevant tube data. The horizontal amplitude response can be raised by the application of suitable correction circuits.

## SECTION H

### Lag

Lag is measured with the appropriate colour filters inserted in the light path. Beam current and signal current are to be adjusted as indicated in the relevant tube data.

**Build-up lag** is measured after a minimum of 10 s of darkness. The figures are typical percentages of the ultimate signal current obtained 60 ms and 200 ms respectively after introduction of the illuminance.

**Decay lag** is measured after a minimum of 5 s of illumination on the target. The figures represent typical residual signals in percentages of the original signal current, 60 ms and 200 ms respectively after removal of the illuminance.

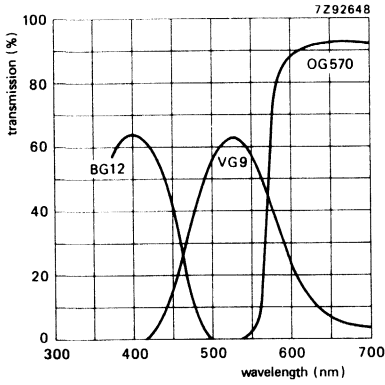

Fig. 4 Transmission of filters BG 12, VG9 and OG570.

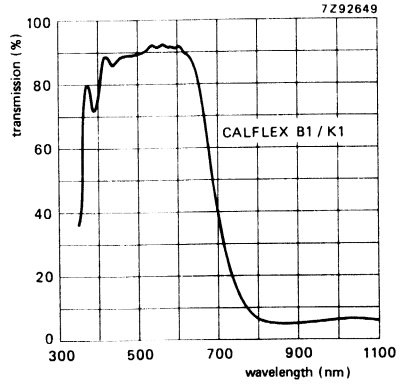

Fig. 5 Typical transmission curve of heat reflecting interference filter CALFLEX B1/K1.



30 mm dia. PLUMBICON TUBES





## CAMERA TUBES

30 mm (1,2 in) diameter Plumbicon® television camera tubes, with standard resolution lead-oxide photoconductive target, for use in high quality monochrome or colour cameras for broadcast, educational or industrial applications.

The XQ1020 series comprises the following versions:

|         |   |
|---------|---|
| XQ1020  | for use in monochrome cameras   |
| XQ1020L | for use in the luminance channel of colour cameras  |
| XQ1020R | for use in the red channel  |
| XQ1020G | for use in the green channel  |
| XQ1020B | for use in the blue channel   |
| XQ1023R | for use in the red channel; extended red response   |
| XQ1025  | for use in monochrome cameras, provided with IR filter  |
| XQ1025L | for use in the luminance channel of colour cameras  |
| XQ1025R | for use in the red channel; extended red response and IR filter   |
| XQ1021  | as XQ1020 series; only difference being the degree of freedom from blemishes on the target (industrial quality tubes) |
| XQ1024  | as XQ1023. Industrial grade   |
| XQ1026  | as XQ1025. Industrial grade   |

### QUICK REFERENCE DATA

|  |         |                  |
|--|---------|------------------|
| Diameter                               |         | 30 mm (1,2 inch) |
| Length                                 | approx. | 210 mm           |
| Provided with anti-halation glass disc |         |                  |
| Focusing                               |         | magnetic         |
| Deflection                             |         | magnetic         |
| Useful target area (scanning area)     |         | 12,8 x 17,1 mm   |
| Spectral response                      |         |                  |
| max. at                                | approx. | 500 nm           |
| cut-off: XQ1020                        | approx. | 650 nm           |
| XQ1023                                 | approx. | 850 to 950 nm    |
| XQ1025                                 | approx. | 750 nm           |
| Sensitivity                            |         |                  |
| XQ1020, XQ1020L                        | typ.    | 400 $\mu$ A/lm   |
| XQ1020R                                | typ.    | 80 $\mu$ A/lmF   |
| XQ1020G                                | typ.    | 165 $\mu$ A/lmF  |
| XQ1020B                                | typ.    | 38 $\mu$ A/lmF   |
| XQ1025, XQ1025L                        | typ.    | 435 $\mu$ A/lm   |
| XQ1023R, XQ1025R                       | typ.    | 130 $\mu$ A/lmF  |
| Resolution at 400 TV lines (5 MHz)     |         |                  |
| XQ1020, XQ1020L                        | typ.    | 40 %             |
| XQ1020R                                | typ.    | 35 %             |
| XQ1020G                                | typ.    | 40 %             |
| XQ1020B                                | typ.    | 50 %             |
| XQ1025, XQ1025L                        | typ.    | 55 %             |
| XQ1023R, XQ1025R                       | typ.    | 55 %             |
| Heater                                 |         | 6,3 V, 190 mA    |

® Registered trademark for television camera tubes.

## OPTICAL DATA

|   |                |
|---|----------------|
| Quality rectangle on photoconductive target (aspect ratio 3 : 4)  | 12,8 x 17,1 mm |
| Orientation of image on target:   |                |
| For correct orientation of the image on the target the vertical scan should be essentially parallel to the plane passing through the tube axis and the marker line on the protecting sleeve at the base |                |
| Faceplate   |                |
| Thickness   | 1,2 ± 0,1 mm   |
| Refractive index  | n = 1,49       |
| Anti-halation glass disc provided with anti-reflective coating  |                |
| Thickness   | 6 ± 0,2 mm     |
| Refractive index  | n = 1,52       |
| XQ1025, R, L are provided with infrared reflecting filter   |                |

## ACCESSORIES

|                                    |                     |
|------------------------------------|---------------------|
| Socket                             | type 56021 or 56603 |
| Deflection and focusing coil unit: |                     |
| Black/white                        | type AT1130S        |
| Colour                             | type AT1130T        |
| Mask for flare reduction           | type 56029          |

## ELECTRICAL DATA

|  |            |            |
|--|------------|------------|
| Deflection   |            | magnetic   |
| Focusing   |            | magnetic   |
| Heating, indirect by a.c. or d.c.; parallel supply   |            |            |
| Heater voltage   | $V_f$      | 6,3 V ± 5% |
| Heater current at $V_f = 6,3$ V  | $I_f$ nom. | 190 mA     |
| Heater current with shunt adaptor  |            | 300 mA     |
| The heater voltage must not exceed an r.m.s. value of 9,5 V. For optimum performance (lifetime and registration stability) stabilization of the heater voltage is recommended. |            |            |
| Capacitance  |            |            |
| Signal electrode to all  | $C_{as}$   | 3 to 6 pF  |
| This capacitance, which is effectively the output impedance, increases when the tube is inserted in the coil unit.   |            |            |

**LIMITING VALUES** (Absolute maximum rating system)

notes

Unless otherwise stated, all voltages are referred to the cathode.

|  |             |      |        |   |
|--|-------------|------|--------|---|
| Signal electrode voltage                     | $V_{as}$    | max. | 50 V   |   |
| Grid 4 voltage                               | $V_{g4}$    | max. | 1100 V |   |
| Grid 3 voltage                               | $V_{g3}$    | max. | 800 V  |   |
| Voltage between grid 4 and grid 3            | $V_{g4/g3}$ | max. | 350 V  |   |
| Grid 2 voltage                               | $V_{g2}$    | max. | 350 V  |   |
| Grid 1 voltage                               |             |      |        |   |
| positive                                     | $V_{g1}$    | max. | 0 V    |   |
| negative                                     | $-V_{g1}$   | max. | 125 V  |   |
| Cathode heating time before drawing          |             |      |        |   |
| cathode current                              | $t_h$       | min. | 1 min  |   |
| Cathode to heater voltage                    |             |      |        |   |
| positive peak                                | $V_{kfp}$   | max. | 50 V   |   |
| negative peak                                | $-V_{kfp}$  | max. | 50 V   |   |
|  |             | min. | 50 °C  |   |
| Ambient temperature, storage and operation   | $T_{amb}$   | min. | -30 °C |   |
|  |             | max. | 50 °C  | 1 |
| Faceplate temperature, storage and operation | T           | min. | -30 °C |   |
| Faceplate illuminance                        | E           | max. | 500 lx | 2 |

**OPERATING CONDITIONS**

For a scanned area of 12,8 x 17,1 mm

|  |             |  |             |   |
|--|-------------|--|-------------|---|
| Cathode voltage                          | $V_k$       |  | 0 V         | 3 |
| Signal electrode voltage                 | $V_{as}$    |  | 45 V        |   |
| Beam current                             | $I_b$       |  |             | 4 |
| Grid 4 voltage                           | $V_{g4}$    |  | 675 V       |   |
| Grid 3 voltage                           | $V_{g3}$    |  | 600 V       |   |
| Grid 2 voltage                           | $V_{g2}$    |  | 300 V       |   |
| Grid 1 voltage                           | $V_{g1}$    |  | V           | 4 |
| Blanking voltage on grid 1, peak to peak | $V_{g1p-p}$ |  | 50 ± 10 V   |   |
| Blanking voltage on cathode              | $V_{kp-p}$  |  | 25 V        |   |
| Faceplate illuminance                    | E           |  | 0 to 10 lx  | 5 |
| Faceplate temperature                    | T           |  | 20 to 45 °C |   |

**ELECTRON GUN CHARACTERISTICS**

Cut off

Grid 1 voltage for cut-off at  $V_{g2} = 300$  V,  
without blanking $V_{g1}$  -30 to -100 V

Blanking voltage, peak to peak

on grid 1

 $V_{g1p-p}$  50 ± 10 V

on cathode

 $V_{kp-p}$  25 V

Grid 2 current at normally required

beam currents

 $I_{g2} \leq 1$  mA

## PERFORMANCE

notes

|   |                     |          |                          |   |
|---|---------------------|----------|--------------------------|---|
| Dark current  | $I_d$               | $\leq$   | 3 nA                     |   |
| Sensitivity at colour temperature of illuminance = 2856 K |                     |          |                          |   |
| XQ1020, XQ1020L   | min. 375            | typ. 400 | $\mu\text{A}/\text{lm}$  | 6 |
| XQ1020R   | min. 70             | typ. 80  | $\mu\text{A}/\text{lmF}$ |   |
| XQ1020G   | min. 130            | typ. 165 | $\mu\text{A}/\text{lmF}$ |   |
| XQ1020B   | min. 35             | typ. 38  | $\mu\text{A}/\text{lmF}$ |   |
| XQ1025, XQ1025L   | min. 390            | typ. 435 | $\mu\text{A}/\text{lm}$  |   |
| XQ1023R, XQ1025R  | min. 120            | typ. 130 | $\mu\text{A}/\text{lmF}$ |   |
| Gamma of transfer characteristics                         |                     |          | $0,95 \pm 0,05$          |   |
| Spectral response, max. at                                | approx.             |          | 500 nm                   |   |
| Spectral response, cut-off at                             | approx.             |          | 650 to 950 nm            |   |
| Spectral response curves                                  | see Figs 1, 2 and 3 |          |                          |   |

Resolution

7

Modulation depth, i.e. uncompensated amplitude response at 400 TV lines at the centre of the picture.

|                                  | XQ1020L<br>XQ1020G | XQ1020R | XQ1020B | XQ1025<br>XQ1025L | XQ1023R<br>XQ1025R |    |
|----------------------------------|--------------------|---------|---------|-------------------|--------------------|----|
| Highlight signal current $I_s$   | 300                | 150     | 150     | 300               | 150                | nA |
| Beam current $I_b$               | 600                | 300     | 300     | 600               | 300                | nA |
| Modulation depth at 400 TV lines |                    |         |         |                   |                    |    |
| typ.                             | 40                 | 35      | 50      | 55                | 55                 | %  |
| min.                             | 35                 | 30      | 45      | 45                | 45                 | %  |

Modulation transfer characteristics: see Fig. 4

Lag (typical values)

8

Light source with a colour temperature of 2856 K. Appropriate filter inserted in the light path for the chrominance tubes R, G and B.

## LOW KEY CONDITIONS (without light bias)

|                  | build-up lag                  |                 | decay lag                     |        |
|------------------|-------------------------------|-----------------|-------------------------------|--------|
|                  | $I_s/I_b = 20/300 \text{ nA}$ |                 | $I_s/I_b = 20/300 \text{ nA}$ |        |
|                  | 60 ms                         | 200 ms          | 60 ms                         | 200 ms |
| XQ1020, L, G     | 95%                           | $\approx 100\%$ | 10%                           | 3,5%   |
| XQ1020R          | 85%                           | $\approx 100\%$ | 12%                           | 4%     |
| XQ1020B          | 70%                           | $\approx 100\%$ | 15%                           | 5%     |
| XQ1025L          | 80%                           | $\approx 100\%$ | 15%                           | 4%     |
| XQ1023R, XQ1025R | 75%                           | $\approx 100\%$ | 16%                           | 5%     |

MECHANICAL DATA

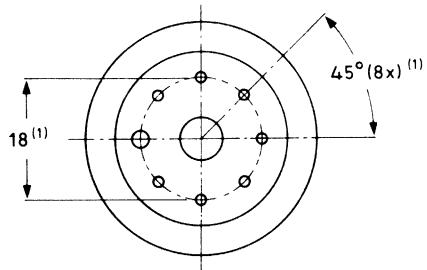
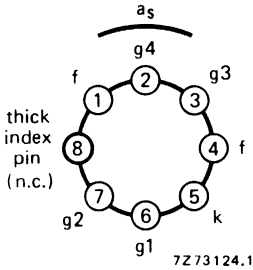
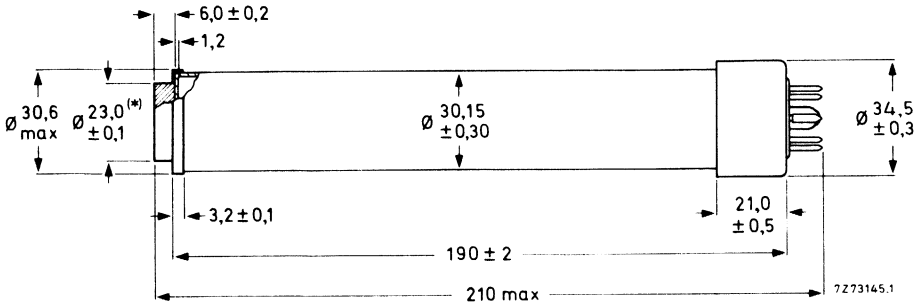

Mounting position: any

Net mass: ≈ 100 g

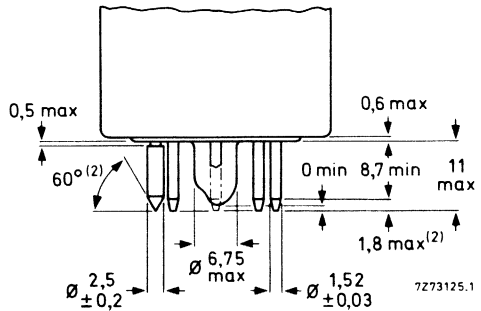

(\*) Distance between axis of anti-halation glass disc and geometrical centre of signal electrode ring, measured in plane of faceplate: max. 0,2 mm. Total glass thickness: 7,2 ± 0,2 mm; n = 1,5.

(1) The base passes a flat gauge with a centre hole with a diameter of 8,230 ± 0,005 mm and holes for passing the pins with the following diameters: 7 holes of 1,690 ± 0,005 mm and one hole of 2,950 ± 0,005 mm. The holes may deviate max. 0,01 mm from their true geometrical position. Thickness of gauge: 7 mm.

(2) The ends of the pins are tapered and/or rounded but not brought to a sharp point.

**NOTES**, see also General Section.

1. The tube can withstand short excursions up to 70 °C without any damage or irreversible degradation in performance.
2. For short intervals. During storage the tube face shall be covered with the plastic hood provided; when the camera is idle the lens shall be capped, in stand-by also the beam will be cut-off.
3. The operating conditions and performance data quoted relate to operation of the tube in coil unit AT1130. See relevant data of deflection/focusing assemblies.
4. The beam current  $I_b$ , as obtained by adjusting the control grid (grid 1) voltage is set to 300 nA for R and B tubes, 600 nA for black and white, L and G tubes.

$I_b$  is not the actual current available in the scanning beam, but is defined as the maximum amount of signal current,  $I_s$ , that can be obtained with this beam.

In the performance figures, for lag, the signal current and beam current conditions are given, e.g. as  $I_s/I_b = 20/300$  nA. This means: with a signal current of 20 nA and a beam setting which just allows a signal current of 300 nA.

N.B. The signal currents are measured with an integrating instrument connected in the signal electrode lead and a uniform illumination on the scanned area. The peak signal currents as measured on a waveform oscilloscope will be a factor  $\alpha$  larger.

$$(\alpha = \frac{100}{100-\beta}; \beta \text{ being the total blanking time in \% , for the CCIR system } \alpha \text{ amounts to } 1,3).$$

5. Typical faceplate illumination level for the XQ1020 and XQ1020L to produce 300 nA signal current will be approx. 3,5 lx. The signal currents stated for the colour tubes XQ1020R, G, B respectively will be obtained with an incident white level (2856 K) on the filter of approx. 8,5 lx. These figures are based on the filters described in note 6, for filter BG12 however a thickness of 1 mm is chosen.

6. Measuring conditions:

Illumination 4,54 lx at black body colour temperature of 2856 K; the appropriate filter inserted in the light path. The signal current obtained in nA is a measure of the colour sensitivity expressed in  $\mu$ A per lumen of white light before the filter. Filters used:

|                  |             |       |           |      |
|------------------|-------------|-------|-----------|------|
| XQ1020R, XQ1025R | Schott      | OG570 | thickness | 3 mm |
| XQ1020G          | Schott      | VG9   | thickness | 1 mm |
| XQ1020B          | Schott      | BG12  | thickness | 3 mm |
| XQ1023R          | Schott      | OG570 | thickness | 3 mm |
|                  | and Calflex | B1/K1 |           |      |

For transmission curves see General Section.

7. As measured with 50 mm Leitz Summicron lens having a sine response of approx. 85% at 400 TV lines at  $f : 5,6$  and appropriate filter inserted in the light path.

The horizontal amplitude response can be raised by means of suitable correction circuits, which affect neither the vertical resolution nor the limiting resolution.

8. Build-up lag.

After 10 s of darkness. The figures are typical percentages of the ultimate signal current obtained 60 ms or 200 ms, respectively, after introduction of the illuminance.

Decay lag.

After the target has been illuminated for at least 5 s. The figures represent typical signals in percentages of the original signal current 60 ms or 200 ms, respectively, after removal of the illuminance.

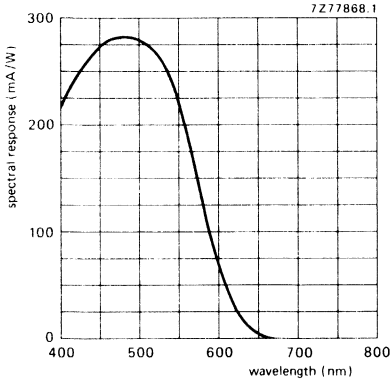

Fig. 1 Typical spectral response for XQ1020.

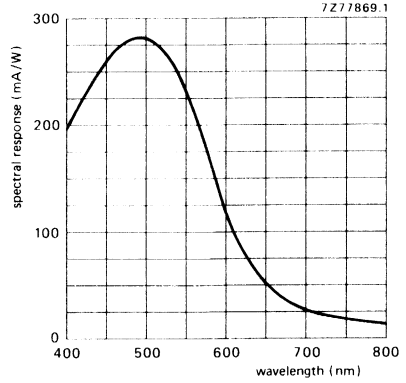

Fig. 2 Typical spectral response for XQ1023.

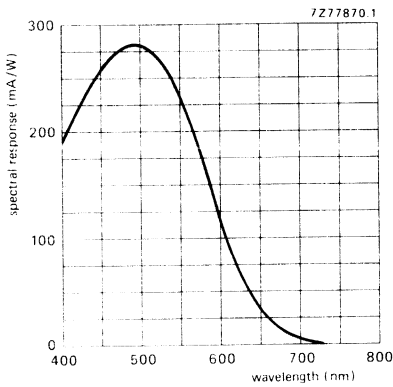

Fig. 3 Typical spectral response for XQ1025.

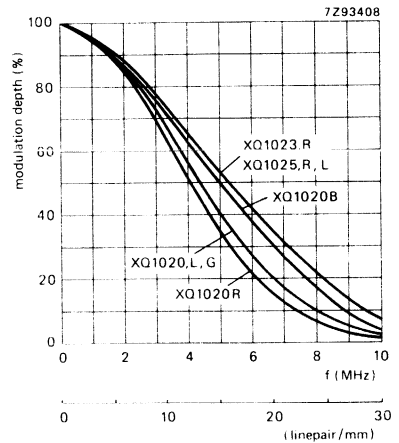

Fig. 4 Typical square-wave response curves.





## CAMERA TUBE

30 mm (1,2 inch) diameter Plumbicon® television camera tube, with standard resolution lead-oxide photoconductive target. The XQ1022 is exclusively intended for use with X-ray image intensifiers with P20 output phosphor in medical equipment.

## QUICK REFERENCE DATA

|                                      |          |                  |
|--------------------------------------|----------|------------------|
| Diameter                             |          | 30 mm (1,2 inch) |
| Length                               | approx.  | 204 mm           |
| Focusing                             | magnetic |                  |
| Deflection                           | magnetic |                  |
| Useful target area, circle, diameter |          | 18 mm            |
| Spectral response                    |          |                  |
| max. at                              | approx.  | 500 nm           |
| cut-off:                             | approx.  | 650 nm           |
| Sensitivity, P20 light source        | typ.     | 530 $\mu$ A/lm   |
| Resolution at 10,5 lp/mm (5 MHz)     |          | 55 %             |
| Heater                               |          | 6,3 V, 190 mA    |

## OPTICAL DATA

|   |  |                  |
|---|--|------------------|
| Quality area on photoconductive target, circle, diameter  |  | 18 mm            |
| Orientation of image on target:   |  |                  |
| For correct orientation of the image on the target the vertical scan should be essentially parallel to the plane passing through the tube axis and the marker line on the protecting sleeve at the base |  |                  |
| Faceplate   |  |                  |
| Thickness   |  | $1,2 \pm 0,1$ mm |
| Refractive index  |  | $n = 1,49$       |
| Without anti-halation glass disc  |  |                  |

## ACCESSORIES

|                                   |  |                     |
|-----------------------------------|--|---------------------|
| Socket                            |  | type 56021 or 56603 |
| Deflection and focusing coil unit |  | type AT1130S        |

## ELECTRICAL DATA

|  |           |                         |
|--|-----------|-------------------------|
| Deflection   |           | magnetic                |
| Focusing   |           | magnetic                |
| Heating, indirect by a.c. or d.c.  |           |                         |
| Heater voltage   | $V_V$     | $6,3 \text{ V} \pm 5\%$ |
| Heater current at $V_f = 6,3 \text{ V}$  | $I_f$ nom | 190 mA                  |
| The heater voltage must not exceed an r.m.s. value of 9,5 V. For optimum performance stabilization of the heater voltage is recommended. |           |                         |
| Capacitance  |           |                         |
| Signal electrode to all  | $C_{as}$  | 3 to 6 pF               |
| This capacitance, which is effectively the output impedance, increases when the tube is inserted in the coil unit.                       |           |                         |

® Registered trademark for television camera tubes.

## LIMITING VALUES (Absolute maximum rating system)

notes

Unless otherwise stated, all voltages are referred to the cathode.

|  |             |      |        |   |
|--|-------------|------|--------|---|
| Signal electrode voltage                               | $V_{as}$    | max. | 50 V   |   |
| Grid 4 voltage   | $V_{g4}$    | max. | 1100 V |   |
| Grid 3 voltage   | $V_{g3}$    | max. | 800 V  |   |
| Voltage between grid 4 and grid 3                      | $V_{g4/g3}$ | max. | 350 V  |   |
| Grid 2 voltage   | $V_{g2}$    | max. | 350 V  |   |
| Grid 2 dissipation                                     | $W_{g2}$    | max. | 1 W    |   |
| Grid 1 voltage   |             |      |        |   |
| positive   | $V_{g1}$    | max. | 0 V    |   |
| negative   | $-V_{g1}$   | max. | 125 V  |   |
| Cathode heating time before drawing<br>cathode current | $t_h$       | min. | 1 min. |   |
| Cathode to heater voltage                              |             |      |        |   |
| positive peak  | $V_{kfp}$   | max. | 50 V   |   |
| negative peak  | $-V_{kfp}$  | max. | 50 V   |   |
| Ambient temperature, storage and operation             | $T_{amb}$   | max. | 50 °C  |   |
|  |             | min. | -30 °C |   |
| Faceplate temperature, storage and operation           | $T$         | max. | 50 °C  | 1 |
|  |             | min. | -30 °C |   |
| Faceplate illuminance                                  | $E$         | max. | 500 lx | 2 |

## OPERATING CONDITIONS

For a scanned circular area with a diameter of 18 mm

|  |             |              |  |   |
|--|-------------|--------------|--|---|
| Cathode voltage                          | $V_k$       | 0 V          |  | 3 |
| Signal electrode voltage                 | $V_{as}$    | 45 V         |  |   |
| Beam current                             | $I_b$       |              |  | 4 |
| Grid 4 voltage                           | $V_{g4}$    | 675 V        |  |   |
| Grid 3 voltage                           | $V_{g3}$    | 600 V        |  |   |
| Grid 2 voltage                           | $V_{g2}$    | 300 V        |  |   |
| Grid 1 voltage                           | $V_{g1}$    | V            |  | 4 |
| Blanking voltage on grid 1, peak to peak | $V_{g1p-p}$ | 50 ± 10 V    |  |   |
| Faceplate illuminance                    | $E$         | approx. 2 lx |  |   |
| Faceplate temperature                    | $T$         | 20 to 45 °C  |  |   |

## ELECTRON GUN CHARACTERISTICS

Cut-off

Grid 1 voltage for cut-off at  $V_{g2} = 300$  V,  
without blanking

$V_{g1}$  -30 to -100 V

Blanking voltage, peak to peak

on grid 1

$V_{g1p-p}$  50 ± 10 V

on cathode

$V_{kp-p}$  25 V

Grid 2 current at normally required  
beam currents

$I_{g2} \leq 1$  mA

**PERFORMANCE**

|   |            |        |                                   | notes |
|---|------------|--------|-----------------------------------|-------|
| Dark current  | $I_d$      | $\leq$ | 3 nA                              |       |
| Sensitivity at colour temperature<br>of illuminance = 2856 K  | min.       | 130    | typ. 175 $\mu\text{A}/\text{lmF}$ | 5     |
| Sensitivity with P20 light source   | min.       | 395    | typ. 530 $\mu\text{A}/\text{lm}$  |       |
| Peak signal current with $E = 1 \text{ lx}$ (P20)   | min.       | 230    | typ. 305 nA                       | 6     |
| Gamma of transfer characteristic  |            |        | $0,95 \pm 0,05$                   |       |
| Spectral response, max. at  | approx.    |        | 500 nm                            |       |
| Spectral response, cut-off at   | approx.    |        | 650 nm                            |       |
| Spectral response curve   | see Fig. 1 |        |                                   |       |
| Resolution  |            |        |                                   | 7     |
| Modulation depth, i.e. uncompensated<br>amplitude response at 10,5 lp/mm<br>(scanned area circle, diameter 18 mm)<br>at the centre of the picture<br>(5 MHz, 400 TV lines)      |            |        | typ. 55 %                         |       |
| Decay lag, light source P20, measured with<br>a signal current of 100 nA, beam adjusted<br>for correct stabilization after the<br>target has been illuminated for at least 5 s. |            |        |                                   |       |
| Residual signal after dark pulse<br>of 60 ms  | max.       | 10     | typ. 5 %                          |       |
| of 200 ms   | max.       | 4      | typ. 2 %                          |       |

MECHANICAL DATA

Dimensions in mm

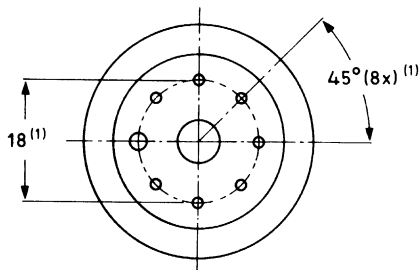
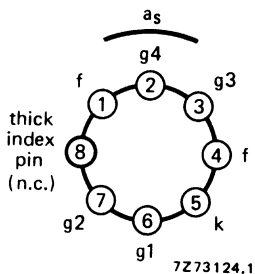
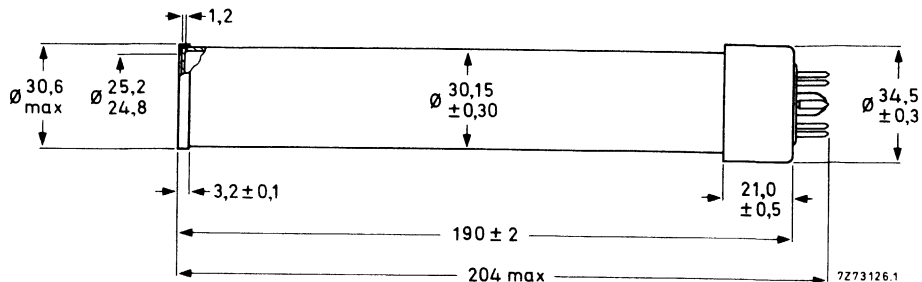

Mounting position: any

Net mass: ≈ 100 g

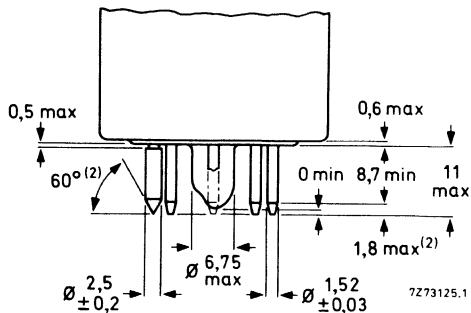

- (1) The base passes a flat gauge with a centre hole with a diameter of  $8,230 \pm 0,005$  mm and holes for passing the pins with the following diameters: 7 holes of  $1,690 \pm 0,005$  mm and one hole of  $2,950 \pm 0,005$  mm. The holes may deviate max. 0,01 mm from their true geometrical position. Thickness of gauge: 7 mm.
- (2) The ends of the pins are tapered and/or rounded but not brought to a sharp point.

NOTES, see also General Section.

1. The tube can withstand short excursions up to 70 °C without damage or irreversible degradation in performance.
2. For short intervals. During storage the tube face shall be covered with the plastic hood provided; when the camera is idle the lens shall be capped, in stand-by also the beam will be cut-off.
3. The operating conditions and performance data quoted relate to operation of the tube in coil unit AT1130. See relevant data of deflection/focusing assemblies. Scanning amplitude should be adjusted such that the useful target area of 18 mm is displayed on a standard monitor as a circular area with a diameter equal to the raster height.
4. The beam current  $I_b$ , as obtained by adjusting the control grid (grid 1) voltage is set to max. 600 nA.  $I_b$  is not the actual current available in the scanning beam, but is defined as the maximum amount of signal,  $I_s$ , that can be obtained with this beam. See note 6.
5. Measuring conditions: illuminance level 4,54 lx at a colour temperature of 2856 K and a filter Schott VG9 inserted in the light path. For transmission of the filter, see General Section.
6. The peak signal currents are measured on a waveform oscilloscope and with a uniform illumination on the 18 mm diameter target area. When measured with an integrating instrument connected in the signal-electrode lead the average signal currents will be smaller:

a. by a factor  $\alpha$   $\left(\alpha = \frac{100 - \beta}{100}\right)$ ,  $\beta$  being the total blanking time in %)

For the CCIR system  $\alpha$  amounts to 0,75

- b. by a factor  $\delta$ ,  $\delta$  being the ratio of the active target area (circle with adjusted 18 mm diameter) to the adjusted scanning amplitudes (18 x 24 mm). This ratio amounts to  $\delta = 0,59$ . The total ratio of integrated signal current,  $I_s$ , to the peak signal current,  $I_{sp}$ , amounts to  $\alpha \times \delta = 0,44$ .
7. As measured with a 50 mm Leitz Summicron lens having a sine response of approximately 85% at 400 TV lines at  $f : 5,6$ . The published 55% typ. is uncorrected. Tube resolution is higher. Measured with 100 nA signal current and a beam current just sufficient to stabilize a signal current of 500 nA. The horizontal amplitude response can be raised by means of suitable correction circuits, which affect neither the vertical resolution nor the limiting resolution.

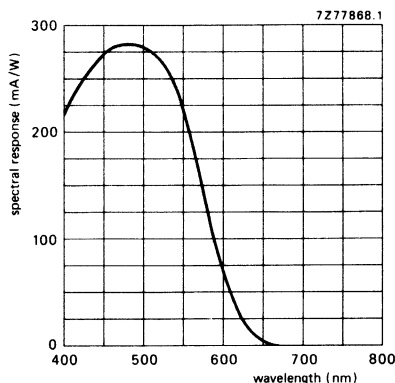

Fig. 1 Typical spectral response for XQ1022.



## CAMERA TUBES

30 mm (1,2 inch) diameter Plumbicon® television camera tubes, with high resolution lead-oxide photo-conductive target, for use in high quality monochrome or colour cameras for broadcast, educational or industrial applications.

The XQ1410 series comprises the following versions:

|         |   |
|---------|---|
| XQ1410  | for use in monochrome cameras                                   |
| XQ1410L | for use in the luminance channel of colour cameras              |
| XQ1410R | for use in the red channel                                      |
| XQ1410G | for use in the green channel                                    |
| XQ1410B | for use in the blue channel                                     |
| XQ1413R | for use in the red channel; extended red response               |
| XQ1415R | for use in the red channel; extended red response and IR filter |
| XQ1415L | for use in the luminance channel of colour cameras              |

The tubes of the XQ1410 series are interchangeable with those of the XQ1020 series and feature an increased resolution and provisions for both fixed and adjustable light bias for reduction of lag under low key conditions.

## QUICK REFERENCE DATA

|  |         |                              |
|--|---------|------------------------------|
| Diameter                               |         | 30 mm (1,2 inch)             |
| Length                                 | approx. | 215 mm                       |
| Provided with anti-halation glass disc |         |                              |
| Focusing                               |         | magnetic                     |
| Deflection                             |         | magnetic                     |
| Useful target area (scanning area)     |         | 12,8 x 17,1 mm               |
| Spectral response                      |         |                              |
| max. at                                | approx. | 500 nm                       |
| cut-off: XQ1410                        | approx. | 650                          |
| XQ1413                                 | approx. | 850 to 950 nm                |
| XQ1415                                 | approx. | 750 nm                       |
| Sensitivity                            |         |                              |
| XQ1410, XQ1410L                        | typ.    | 400 $\mu\text{A}/\text{lm}$  |
| XQ1410R                                | typ.    | 80 $\mu\text{A}/\text{lmF}$  |
| XQ1410G                                | typ.    | 165 $\mu\text{A}/\text{lmF}$ |
| XQ1410B                                | typ.    | 38 $\mu\text{A}/\text{lmF}$  |
| XQ1413R, XQ1415R                       | typ.    | 125 $\mu\text{A}/\text{lmF}$ |
| XQ1415L                                | typ.    | 435 $\mu\text{A}/\text{lm}$  |
| Resolution at 400 TV lines (5 MHz)     |         |                              |
| XQ1410, XQ1410L                        | typ.    | 55 %                         |
| XQ1410R                                | typ.    | 50 %                         |
| XQ1410G                                | typ.    | 55 %                         |
| XQ1410B                                | typ.    | 60 %                         |
| XQ1413R, XQ1415R                       | typ.    | 55 %                         |
| XQ1415L                                | typ.    | 60 %                         |
| Heater                                 |         | 6,3 V, 190 mA                |

® Registered trademark for television camera tubes.

## OPTICAL DATA

notes

|  |                |
|--|----------------|
| Quality rectangle on photoconductive target (aspect ratio 3 : 4)   | 12,8 x 17,1 mm |
| Orientation of image on target:<br>For correct orientation of the image on the target the vertical scan should be essentially parallel to the plane passing through the tube axis and the marker line on the protecting sleeve at the base |                |
| Faceplate  |                |
| Thickness  | 1,2 + 0,1 mm   |
| Refractive index   | n = 1,49       |
| Anti-halation glass disc provided with anti reflective coating   |                |
| Thickness  | 6 + 0,2 mm     |
| Refractive index   | n = 1,52       |
| XQ1415R and XQ1415L are provided with infrared reflecting filter   |                |

## ACCESSORIES

|   |                     |   |
|---|---------------------|---|
| Socket                                    | type 56021 or 56603 |   |
| Deflection and focusing coil unit:        |                     |   |
| Black/white                               | type AT1130S        |   |
| Colour                                    | type AT1130T        |   |
| Mask for flare reduction                  | type 56029          |   |
| For adjustable light bias: lamp in holder | type 56106          | 1 |
| Adaptors for fixed light bias R tubes     | type 56123          | 1 |
| Adaptors for fixed light bias G, L tubes  | type 56124          |   |
| Adaptors for fixed light bias B tubes     | type 56125          |   |

## ELECTRICAL DATA

|  |                      |
|--|----------------------|
| Deflection   | magnetic             |
| Focusing   | magnetic             |
| Heating, indirect by a.c. or d.c.; parallel supply   |                      |
| Heater voltage   | $V_f$ 6,3 V $\pm$ 5% |
| Heater current at $V_f = 6,3$ V  | $I_f$ nom. 190 mA    |
| Heater current with light bias adaptor   | 300 mA               |
| The heater voltage must not exceed an r.m.s. value of 9,5 V. For optimum performance (lifetime and registration stability) stabilization of the heater voltage is recommended. |                      |
| Capacitance  |                      |
| Signal electrode to all  | $C_{as}$ 3 to 6 pF   |
| This capacitance, which is effectively the output impedance, increases when the tube is inserted in the coil unit.   |                      |



**LIMITING VALUES** (Absolute maximum rating system)

notes

Unless otherwise stated, all voltages are referred to the cathode.

|  |             |      |        |   |
|--|-------------|------|--------|---|
| Signal electrode voltage                     | $V_{as}$    | max. | 50 V   |   |
| Grid 4 voltage                               | $V_{g4}$    | max. | 1100 V |   |
| Grid 3 voltage                               | $V_{g3}$    | max. | 800 V  |   |
| Voltage between grid 4 and grid 3            | $V_{g4/g3}$ | max. | 350 V  |   |
| Grid 2 voltage                               | $V_{g2}$    | max. | 350 V  |   |
| Grid 2 dissipation                           | $W_{g2}$    | max. | 1 W    |   |
| Grid 1 voltage                               |             |      |        |   |
| positive                                     | $V_{g1}$    | max. | 0 V    |   |
| negative                                     | $-V_{g1}$   | max. | 125 V  |   |
| Cathode heating time before drawing          |             |      |        |   |
| cathode current                              | $t_h$       | min. | 1 min. |   |
| Cathode to heater voltage                    |             |      |        |   |
| positive peak                                | $V_{kfp}$   | max. | 50 V   |   |
| negative peak                                | $-V_{kfp}$  | max. | 50 V   |   |
| Ambient temperature, storage and operation   | $T_{amb}$   | max. | 50 °C  |   |
|  |             | min. | -30 °C |   |
| Faceplate temperature, storage and operation | $T$         | max. | 50 °C  | 2 |
|  |             | min. | -30 °C |   |
| Faceplate illuminance                        | $E$         | max. | 500 lx | 3 |

**OPERATING CONDITIONS**

For a scanned area of 12,8 x 17,1 mm

|  |             |             |   |
|--|-------------|-------------|---|
| Cathode voltage                          | $V_k$       | 0 V         | 4 |
| Signal electrode voltage                 | $V_{as}$    | 45 V        |   |
| Beam current                             | $I_b$       |             | 5 |
| Grid 4 voltage                           | $V_{g4}$    | 675 V       |   |
| Grid 3 voltage                           | $V_{g3}$    | 600 V       |   |
| Grid 2 voltage                           | $V_{g2}$    | 300 V       |   |
| Grid 1 voltage                           | $V_{g1}$    | V           | 5 |
| Blanking voltage on grid 1, peak to peak | $V_{g1p-p}$ | 50 ± 10 V   |   |
| Faceplate illuminance                    | $E$         | 0 to 10 lx  | 6 |
| Temperature of faceplate                 | $T$         | 20 to 45 °C |   |

**ELECTRON GUN CHARACTERISTICS**

Cut off

|   |             |               |
|---|-------------|---------------|
| Grid 1 voltage for cut-off at $V_{g2} = 300$ V,<br>without blanking | $V_{g1}$    | -30 to -100 V |
| Blanking voltage, peak to peak                                      |             |               |
| on grid 1   | $V_{g1p-p}$ | 50 ± 10 V     |
| on cathode  | $V_{kp-p}$  | 25 V          |
| Grid 2 current at normally required<br>beam currents                | $I_{g2}$    | ≤ 1 mA        |

## PERFORMANCE

|   |         |                     |                      |       |
|---|---------|---------------------|----------------------|-------|
| Dark current (without light bias)   | $I_d$   | $\leq$              | 2 nA                 | notes |
| Sensitivity at colour temperature of illuminance = 2856 K   |         |                     |                      | 7     |
| XQ1410, XQ1410L   | min.    | 365                 | typ. 400 $\mu$ A/lm  |       |
| XQ1410R   | min.    | 70                  | typ. 80 $\mu$ A/lmF  |       |
| XQ1410G   | min.    | 135                 | typ. 165 $\mu$ A/lmF |       |
| XQ1410B   | min.    | 35                  | typ. 38 $\mu$ A/lmF  |       |
| XQ1415L   | min.    | 390                 | typ. 435 $\mu$ A/lmF |       |
| XQ1413R, XQ1415R  | min.    | 115                 | typ. 125 $\mu$ A/lm  |       |
| Gamma of transfer characteristics   |         |                     | 0,95 $\pm$ 0,05      |       |
| Spectral response, max. at  | approx. |                     | 500 nm               |       |
| Spectral response, cut-off at   | approx. |                     | 650 to 950 nm        |       |
| Spectral response curves  |         | see Figs 1, 2 and 3 |                      |       |
| Resolution  |         |                     |                      | 8     |
| Modulation depth, i.e. uncompensated amplitude response at 400 TV lines at the centre of the picture. |         |                     |                      |       |

|                                  | XQ1410L<br>XQ1410G | XQ1410R | XQ1410B | XQ1415L | XQ1413R<br>XQ1415R |    |
|----------------------------------|--------------------|---------|---------|---------|--------------------|----|
| Highlight signal current $I_s$   | 300                | 150     | 150     | 300     | 150                | nA |
| Beam current $I_b$               | 600                | 300     | 300     | 600     | 300                | nA |
| Modulation depth at 400 TV lines |                    |         |         |         |                    |    |
| typ.                             | 55                 | 50      | 60      | 60      | 55                 | %  |
| min.                             | 50                 | 40      | 50      | 50      | 45                 | %  |

Modulation transfer characteristics: see Fig. 4

Lag (typical values)

9, 10

Light source with a colour temperature of 2856 K. Appropriate filter inserted in the light path for the chrominance tubes R, G and B.

## LOW KEY CONDITIONS (with light bias of 3 nA)

|              | build-up lag          |                | decay lag             |        |
|--------------|-----------------------|----------------|-----------------------|--------|
|              | $I_s/I_b = 20/300$ nA |                | $I_s/I_b = 20/300$ nA |        |
|              | 60 ms                 | 200 ms         | 60 ms                 | 200 ms |
| XQ1410, L, G | 98%                   | $\approx$ 100% | 7%                    | 2%     |
| XQ1410R      | 98%                   | $\approx$ 100% | 8%                    | 3%     |
| XQ1410B      | 95%                   | $\approx$ 100% | 11%                   | 3,5%   |
| XQ1413R      | 90%                   | $\approx$ 100% | 13%                   | 3,5%   |
| XQ1415R      | 90%                   | $\approx$ 100% | 13%                   | 3,5%   |
| XQ1415L      | 95%                   | $\approx$ 100% | 8%                    | 3%     |

Typical effect of light bias on build-up and decay lag under low key signal current and beam settings are shown in Figs 5 to 14

Shading of light bias induced dark current

12,5%

11

**MECHANICAL DATA**

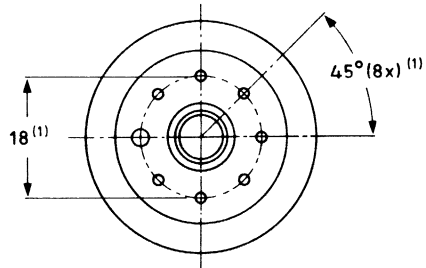
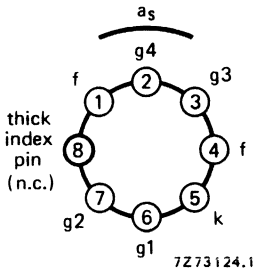
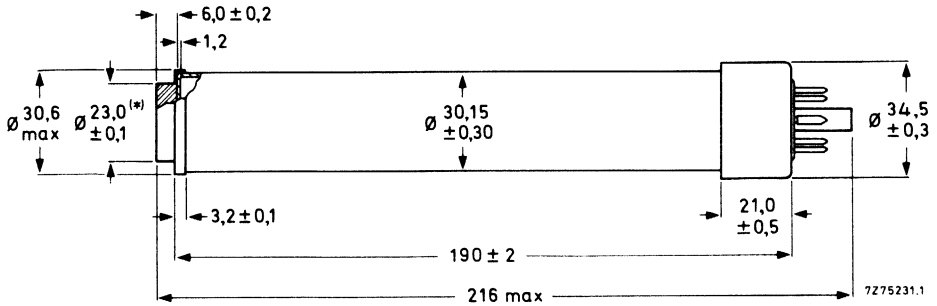

Mounting position: any

Mass:  $\approx 100$  g

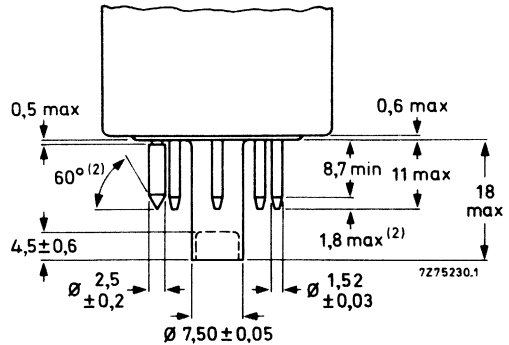

(\*) Distance between axis of anti-halation glass disc and geometrical centre of signal electrode ring, measured in plane of faceplate: max. 0,2 mm. Total glass thickness:  $7,2 \pm 0,2$  mm.

(1) The base passes a flat gauge with a centre hole  $8,230 \pm 0,005$  mm diameter and holes for passing the pins with the following diameters: 7 holes of  $1,690 \pm 0,005$  mm and one hole of  $2,950 \pm 0,005$  mm. The holes may deviate max. 0,01 mm from their true geometrical position. Thickness of gauge 7 mm.

(2) The ends of the pins are tapered and/or rounded but not brought to a sharp point.

**NOTES**, see also General Section.

1. a. **Adjustable light bias.** The light bias lamp assembly as supplied with each tube, type 56106, fits in the metal tube cemented to the pumping stem of the tube. The tube and the light bias lamp assembly will fit properly in the sockets type 56021 and 56025. The wires should be connected to a source, capable of supplying max. 110 mA at 5 V.  
 Considerations and recommendations for the choice of such a source, depending on the application, are supplied with each tube. The light bias lamp projects its light via a blue-green transmitting filter on the pumping stem where it is conducted to the target to cause a bias illumination. The desired amount of light bias can be obtained by adjusting the current through the filament of the lamp. See also note 10.
- b. **Fixed light bias.** An adapter is supplied with each tube, connecting a small lamp via a calibrated series resistor to the heater pins. The heater supply should be stabilized at  $6,3 \pm 0,1$  V and be capable of supplying an additional current of 95 mA. The adaptor is colour coded according to the application of the tube.
2. The tube can withstand short excursions up to 70 °C without damage or irreversible degradation in performance.
3. For short intervals. During storage the tube face shall be covered with the plastic hood provided; when the camera is idle the lens shall be capped, in stand-by also the beam will be cut-off.
4. The operating conditions and performance data quoted relate to operation of the tube in coil unit AT1130. See relevant data of deflection/focusing assemblies.
5. The beam current  $I_B$ , as obtained by adjusting the control grid (grid 1) voltage is set to 300 nA for R and B tubes, 600 nA for black and white, L and G tubes.  $I_B$  is not the actual current available in the scanning beam, but is defined as the maximum amount of signal current,  $I_S$ , that can be obtained with this beam.

In the performance figures for lag, the signal current and beam current conditions are given, e.g. as  $I_S/I_B = 20/300$  nA. This means: with a signal current of 20 nA and a beam setting which just allows a signal current of 300 nA.

N.B. The signal currents are measured with an integrating instrument connected in the signal electrode lead and a uniform illumination of the scanned area.

The peak signal currents as measured on a waveform oscilloscope will be a factor  $\alpha$  larger.

$$\alpha = \frac{100}{100-\beta}; \quad \beta \text{ being the total blanking time in \% : for the CCIR system } \alpha = 1,3.$$

6. Typical faceplate illumination level for the XQ1410 and XQ1410L to produce 300 nA signal current will be approx. 3,5 lx. The signal currents stated for the colour tubes XQ1410R, G and B will be obtained with an incident white light level (2856 K) on the filter of approx. 8,5 lx. These figures are based on the filters described in note 7. For filter BG12, however, a thickness of 1 mm is chosen.
7. **Measuring conditions:** illuminance level 4,54 lx at a colour temperature of 2856 K and the appropriate filter inserted in the light path. The signal current obtained in nA is a measure of the colour sensitivity expressed in  $\mu$ A per lumen of white light before the filter. Filters used are:

|                  |             |       |           |      |
|------------------|-------------|-------|-----------|------|
| XQ1410R, XQ1415R | Schott      | OG570 | thickness | 3 mm |
| XQ1410G          | Schott      | VG9   | thickness | 1 mm |
| XQ1410B          | Schott      | BG12  | thickness | 3 mm |
| XQ1413R          | Schott      | OG570 | thickness | 3 mm |
|                  | and Calflex | B1/K1 |           |      |

For transmission curves see General Section.

8. As measured with a 50 mm Leitz Summicron lens having a sine response of approximately 85% at 400 TV lines at  $f : 5,6$  and the appropriate filter inserted in the light path. The horizontal amplitude response can be raised by means of suitable correction circuits, which affect neither the vertical resolution nor the limiting resolution.
9. **Build-up lag**  
After 10 s of darkness. The figures are typical percentages of the ultimate signal current obtained 60 ms and 200 ms, respectively, after the introduction of the illuminance.  
**Decay lag**  
After the target has been illuminated for at least 5 s. The figures represent typical signals in percentages of the original signal current 60 ms and 200 ms, respectively, after removal of the illuminance.
10. A reduction lag, especially under low key conditions is obtained when light bias is applied. Infrared light with a wavelength  $> 600$  nm in the light bias should be avoided.
  - a. For monochrome operation a light bias corresponding to 4,5 nA dark current is usually adequate for excellent speed of response. The adapter as supplied with the tube will produce a fixed light bias in the order of this magnitude.
  - b. *Adjustable* light bias (colour camera).  
In a colour camera the speeds of response of the tubes can be balanced by adjusting the amount of light bias per tube.  
In a 3-tube colour camera for instance it is recommended to first adjust the tubes to their normal highlight signal current and beam current settings and then point the camera at a dark scene comprising a metronome. The moving hand of the metronome carries a small white square. The illuminance should be chosen such that the square produces a peak signal of approximately 50 nA in the green chrominance channel. A maximum of 3 nA artificial dark current shall then be introduced in the green chrominance tube. Subsequently light bias shall be applied to the tubes in the red and blue channels until the lag of the three tubes is neutralized.
  - c. *Fixed* light bias (colour camera).  
A typical setting for correct speeds of response in a 3-tube colour camera would be approximately 3 nA(p) (R), 2 nA(p) (G) and 3,5 nA(p) (B). The adapters as supplied with the tubes will produce fixed bias of the same magnitude.
11. Deviation of the level of any of the four corners, i.e. 10% inwards in H and V direction from the level in the picture centre. With the settings suggested in note 10 black shading compensation in the camera video processing amplifier will not normally be required. Further improvement in lag can be obtained by applying still higher light bias levels. It may then be necessary to use black shading compensation in the video processing amplifier.

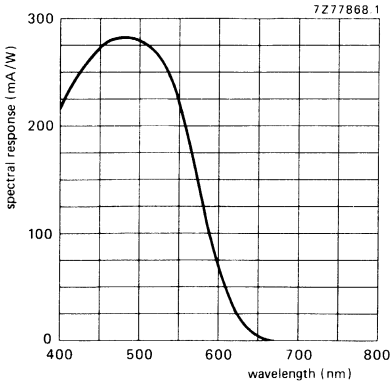

Fig. 1 Typical spectral response for XQ1410.

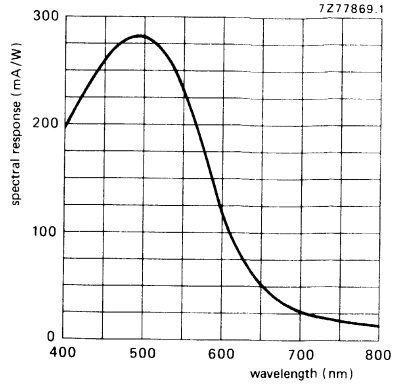

Fig. 2 Typical spectral response for XQ1413.

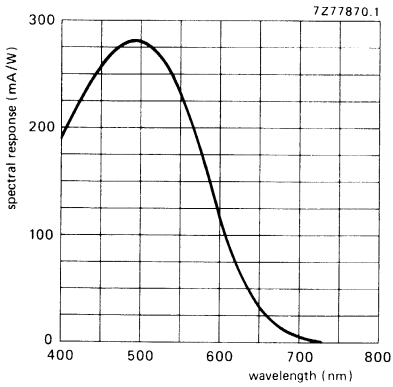

Fig. 3 Typical spectral response for XQ1415.

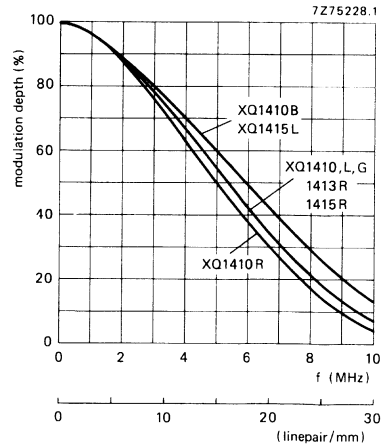

Fig. 4 Typical square wave response curves.

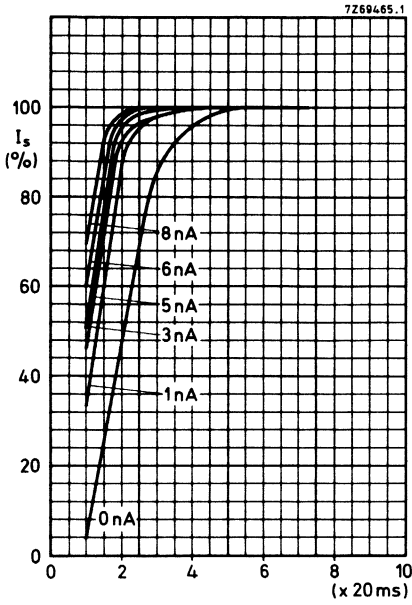

Fig. 5.

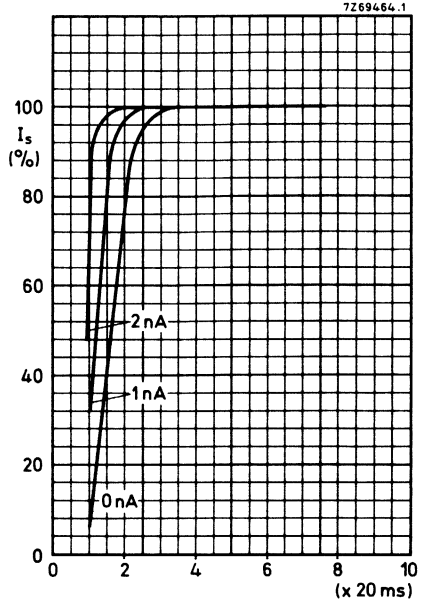

Fig. 6.

**Build-up lag (see note 9)**

Light bias induced dark current as parameter.

Fig. 5 XQ1410R :  $I_s/I_b = 20/300$  nA.

Fig. 6 XQ1410, XQ1410L, XQ1419G :  $I_s/I_b = 40/600$  nA.

Fig. 7 XQ1410B :  $I_s/I_b = 20/300$  nA.

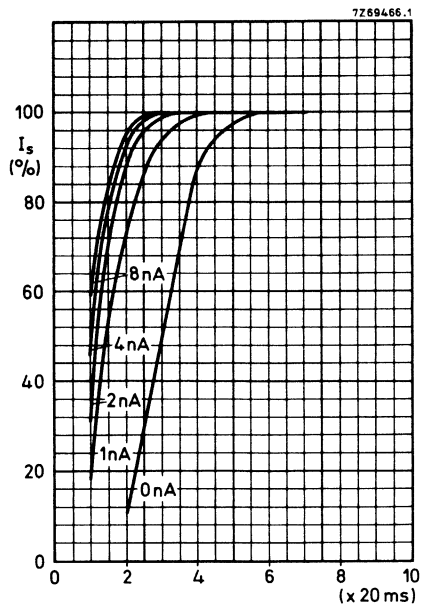

Fig. 7.

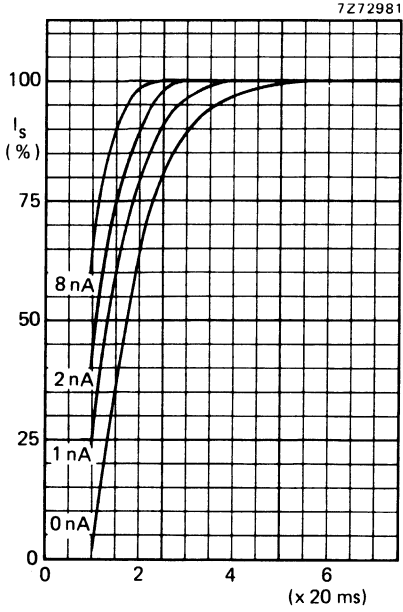

Fig. 8.

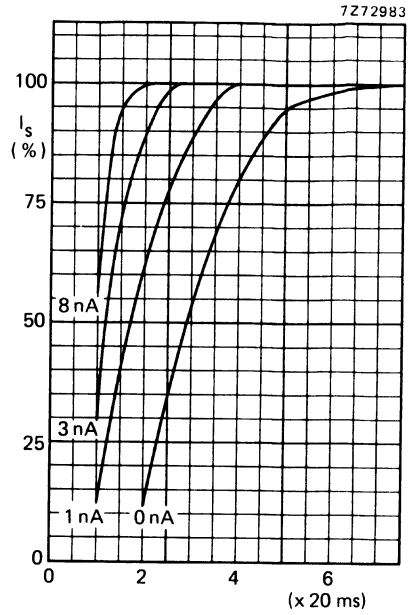

Fig. 9.

**Build-up lag** (see note 9)

Light bias induced dark current as parameter.

Fig. 8 XQ1415L:  $I_s/I_b = 40/600$  nA.

Fig. 9 XQ1413R, XQ1415R:  $I_s/I_b = 20/300$  nA.



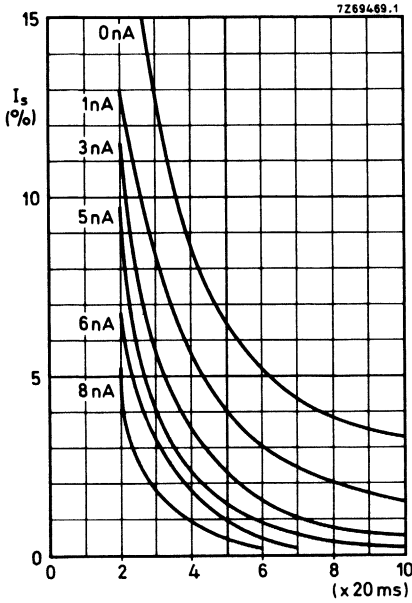

Fig. 10.

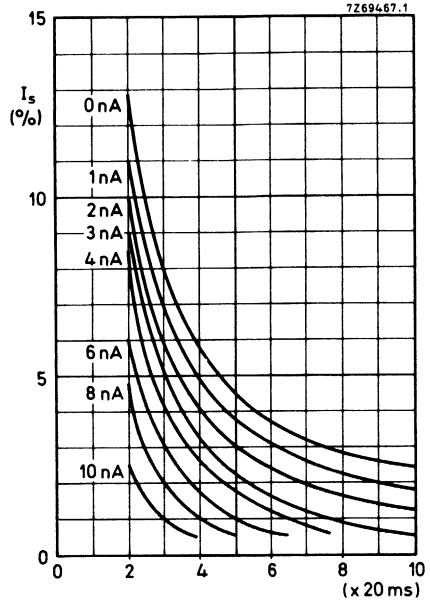

Fig. 11.

**Decay lag (see note 9)**

Light bias induced dark current as parameter.

Fig. 10 XQ1410R :  $I_s/I_b = 20/300$  nA.

Fig. 11 XQ1410, XQ1410L, XQ1410G :  $I_s/I_b = 40/600$  nA.

Fig. 12 XQ1410B :  $I_s/I_b = 20/300$  nA.

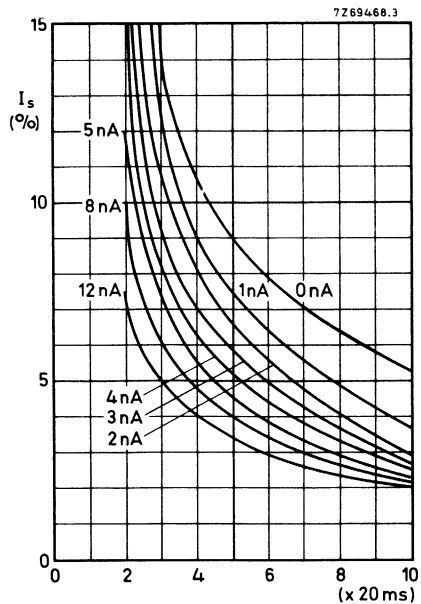

Fig. 12.

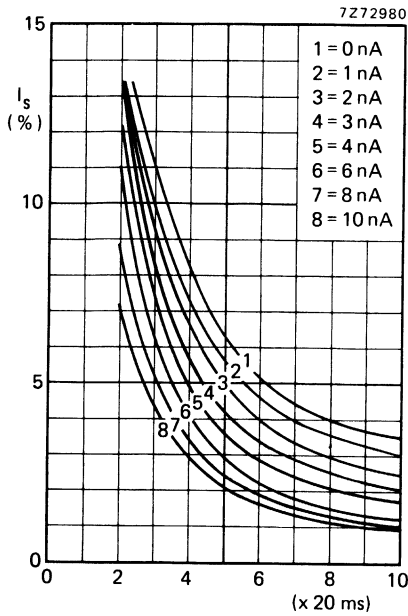

Fig. 13.

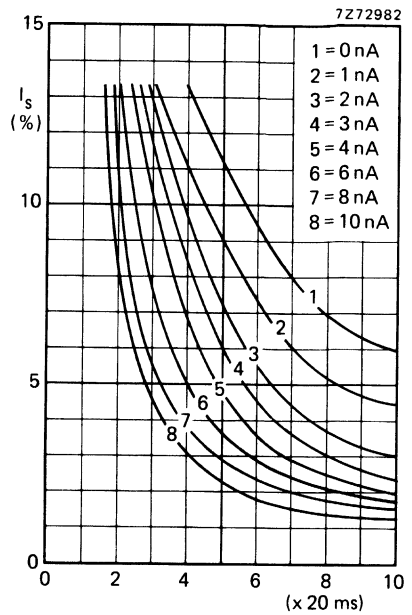

Fig. 14.

**Decay lag** (see note 9)

Light bias induced dark current as parameter.

Fig. 13 XQ1415L :  $I_s/I_b = 40/600$  nA.

Fig. 14 XQ1413R, XQ1415R :  $I_s/I_b = 20/300$  nA.

## CAMERA TUBES

30 mm (1,2 inch) diameter Plumbicon® television camera tubes, with high resolution lead-oxide photoconductive target, for use in high quality monochrome or colour cameras for broadcast; educational or industrial applications.

The XQ1520 series comprises the following versions:

|         |   |
|---------|---|
| XQ1520  | for use in monochrome cameras                                   |
| XQ1520L | for use in the luminance channel of colour cameras              |
| XQ1520R | for use in the red channel                                      |
| XQ1520G | for use in the green channel                                    |
| XQ1520B | for use in the blue channel                                     |
| XQ1523R | for use in the red channel; extended red response               |
| XQ1525R | for use in the red channel; extended red response and IR filter |
| XQ1525L | for use in the luminance channel of colour cameras              |

Special features are:

- Anti-Comet-Tail (ACT) electron gun for highlight handling
- New photoconductive target for increased resolution
- Provisions for light bias to reduce lag

### QUICK REFERENCE DATA

|  |                                   |
|--|-----------------------------------|
| ACT electron gun                       |                                   |
| Diameter                               | 30 mm (1,2 inch)                  |
| Length                                 | approx. 215 mm                    |
| Provided with anti-halation glass disc |                                   |
| Focusing                               | magnetic                          |
| Deflection                             | magnetic                          |
| Useful target area (scanning area)     | 12,8 x 17,1 mm                    |
| Spectral response                      |                                   |
| max. at                                | approx. 500 nm                    |
| cut-off: XQ1520                        | approx. 650 nm                    |
| XQ1523                                 | approx. 850 to 950 nm             |
| XQ1525                                 | approx. 750 nm                    |
| Sensitivity                            |                                   |
| XQ1520, XQ1520L                        | typ. 400 $\mu\text{A}/\text{lm}$  |
| XQ1520R                                | typ. 80 $\mu\text{A}/\text{lmF}$  |
| XQ1520G                                | typ. 165 $\mu\text{A}/\text{lmF}$ |
| XQ1520B                                | typ. 38 $\mu\text{A}/\text{lmF}$  |
| XQ1523R, XQ1525R                       | typ. 125 $\mu\text{A}/\text{lmF}$ |
| XQ1525L                                | typ. 435 $\mu\text{A}/\text{lm}$  |
| Resolution at 400 TV lines (5 MHz)     |                                   |
| XQ1520, XQ1520L                        | typ. 55 %                         |
| XQ1520R                                | typ. 50 %                         |
| XQ1520G                                | typ. 55 %                         |
| XQ1520B                                | typ. 60 %                         |
| XQ1523R, XQ1525R                       | typ. 55 %                         |
| XQ1525L                                | typ. 60 %                         |
| Heater                                 | 6,3 V, 190 mA                     |

® Registered trademark for television camera tubes.

## OPTICAL DATA

notes

|  |                |
|--|----------------|
| Quality rectangle on photoconductive target (aspect ratio 3 : 4)   | 12,8 x 17,1 mm |
| Orientation of image on target:<br>For correct orientation of the image on the target the vertical scan should be essentially parallel to the plane passing through the tube axis and the marker line on the protecting sleeve at the base |                |
| Faceplate Thickness  | 1,2 ± 0,1 mm   |
| Refractive index   | n = 1,49       |
| Anti-halation glass disc provided with anti-reflective coating   |                |
| Thickness  | 6 ± 0,2 mm     |
| Refractive index   | n = 1,52       |
| XQ1525R and XQ1525L are provided with an infrared reflecting filter  |                |

## ACCESSORIES

|   |              |   |
|---|--------------|---|
| Socket                                    | type 56025   |   |
| Deflection and focusing coil unit:        |              |   |
| Black/white                               | type AT1130S |   |
| Colour                                    | type AT1130T |   |
| Mask for flare reduction                  | type 56029   |   |
| For adjustable light bias: lamp in holder | type 56106   | 1 |
| Adapters for fixed light bias R tubes     | type 56123   |   |
| Adapters for fixed light bias G, L tubes  | type 56124   |   |
| Adapters for fixed light bias B tubes     | type 56125   |   |

## ELECTRICAL DATA

|  |                    |
|--|--------------------|
| Deflection   | magnetic           |
| Focusing   | magnetic           |
| Heating, indirect by a.c. or d.c.; parallel supply   |                    |
| Heater voltage   | $V_f$ 6,3 V ± 5%   |
| Heater current at $V_f = 6,3$ V  | $I_f$ nom. 190 mA  |
| Heater current with light bias adapter   | 300 mA             |
| The heater voltage must not exceed an r.m.s. value of 9,5 V. For optimum performance (lifetime and registration stability) stabilization of the heater voltage is recommended. |                    |
| Capacitance  |                    |
| Signal electrode to all  | $C_{as}$ 3 to 6 pF |
| This capacitance, which is effectively the output impedance, increases when the tube is inserted in the coil unit.   |                    |

**LIMITING VALUES** (Absolute maximum rating system)

notes

Unless otherwise stated, all voltages are referred to the cathode.

|  |             |              |                 |   |
|--|-------------|--------------|-----------------|---|
| Signal electrode voltage   | $V_{as}$    | max.         | 50 V            |   |
| Grid 6 (mesh) voltage  | $V_{g6}$    | max.         | 1100 V          |   |
| Grid 5 (collector) voltage   | $V_{g5}$    | max.         | 800 V           |   |
| Voltage between grid 6 and grid 5                                  | $V_{g6/g5}$ | max.         | 350 V           |   |
| Grid 4 (limiter) and grid 2 (accelerator,<br>first anode ) voltage | $V_{g2,4}$  | max.         | 350 V           |   |
| Grid 3 (auxiliary) voltage   | $V_{g3}$    | max.         | 350 V           |   |
| Grid 1 (control) voltage,<br>positive                              | $V_{g1}$    | max.         | 0 V             |   |
| negative   | $-V_{g1}$   | max.         | 200 V           |   |
| Cathode heating time before drawing<br>cathode current             | $t_h$       | min.         | 1 min           |   |
| Cathode to heater voltage<br>positive peak                         | $V_{kfp}$   | max.         | 50 V            |   |
| negative peak  | $-V_{kfp}$  | max.         | 50 V            |   |
| Ambient temperature, storage and operation                         | $T_{amb}$   | max.<br>min. | 50 °C<br>-30 °C |   |
| Faceplate temperature, storage and operation                       | $T$         | max.<br>min. | 50 °C<br>-30 °C | 2 |
| Faceplate illuminance  | $E$         | max.         | 500 lx          | 3 |

**OPERATING CONDITIONS** with ACT action

4, 5

For a scanned area of 12,8 x 17,1 mm. All voltages are specified with respect to the cathode potential during the read-out mode, unless otherwise indicated.

6, 7, 8

|  |            |  |           |    |
|--|------------|--|-----------|----|
| Cathode voltage<br>during read-out mode                              | $V_k$      |  | 0 V       |    |
| during ACT mode  | $V_k$      |  | 0 to 15 V |    |
| Signal electrode voltage   | $V_{as}$   |  | 45 V      |    |
| Grid 6 (mesh) voltage  | $V_{g6}$   |  | 675 V     |    |
| Grid 5 (collector) voltage   | $V_{g5}$   |  | 600 V     |    |
| Grid 4 (limiter) and grid 2 (accelerator,<br>or first anode) voltage | $V_{g2,4}$ |  | 300 V     |    |
| Grid 3 (auxiliary) voltage<br>during read-out mode                   | $V_{g3}$   |  |           | 8  |
| during ACT mode  | $V_{g3}$   |  |           | 8  |
| Grid 1 (control) voltage<br>during read-out mode                     | $V_{g1}$   |  |           | 10 |
| during ACT mode  | $V_{g1}$   |  |           | 8  |
| Blanking voltage on grid 1, peak                                     | $V_{g1p}$  |  | 50 V      |    |

Typical beam current, signal current and pulse settings:

|                      |           | XQ1520<br>XQ1520L<br>XQ1525L | XQ1520R<br>XQ1523R<br>XQ1525R | XQ1520G | XQ1520B      |
|----------------------|-----------|------------------------------|-------------------------------|---------|--------------|
| Signal current, peak | $I_{sp}$  | 0,3                          | 0,15                          | 0,3     | 0,15 $\mu A$ |
| Beam current, peak   | $I_{bp}$  | 0,6                          | 0,3                           | 0,6     | 0,3 $\mu A$  |
| ACT level, peak      |           | 0,4                          | 0,2                           | 0,4     | 0,2 $\mu A$  |
| Cathode pulse        | $V_{kp}$  | 7                            | 3,5                           | 7       | 3,5 V        |
| Grid 1 pulse         | $V_{g1p}$ | 27                           | 23,5                          | 27      | 23,5 V       |
| Grid 3 pulse         | $V_{g3p}$ |                              |                               |         | see note 8   |

|                       |  |             |    |
|-----------------------|--|-------------|----|
| Faceplate illuminance |  | 0 to 10 lx  | 11 |
| Faceplate temperature |  | 20 to 45 °C | 2  |

**ELECTRON GUN CHARACTERISTICS**

Cut off

Grid 1 voltage for cut-off at  $V_{g2,4} = 300 V$ , without blanking or ACT pulses

$V_{g1}$  -40 to -110 V

Blanking voltage, peak to peak at  $V_{g2,4} = 300 V$  on grid 1

$V_{g1p-p}$  50 ± 10 V 12

Grids 2 and 4 current

$I_{g2,4}$  < 0,2 mA 13

Grids 3, 5 and 6 current

$I_{g3,5,6}$  13

Pulse timing and amplitude requirements (ACT)

7

**PERFORMANCE**

Dark current, without light bias

$I_d$  ≤ 1 nA

Sensitivity at colour temperature of illuminance = 2856 K

14

XQ1520, XQ1520L

min. 365 typ. 400  $\mu A/lm$

XQ1520R

min. 70 typ. 80  $\mu A/lmF$

XQ1520G

min. 135 typ. 165  $\mu A/lmF$

XQ1520B

min. 35 typ. 38  $\mu A/lmF$

XQ1523R, XQ1525R

min. 115 typ. 125  $\mu A/lmF$

XQ1525L

min. 390 typ. 435  $\mu A/lmF$

Gamma of transfer characteristics

0,95 ± 0,05

Light transfer characteristics with ACT

see Fig. 2

Highlight handling

≥ 5 lens stops 15

Spectral response, max. at

approx. 500 nm

Spectral response, cut-off: XQ1520

approx. 650 nm

Spectral response, cut-off: XQ1523

approx. 850 to 950 nm

Spectral response, cut-off: XQ1525

approx. 750 nm

Spectral response curves

see Figs 3, 4 and 5

notes

16

## Resolution

Modulation depth, i.e. uncompensated amplitude response at 400 TV lines at the centre of the picture. The figures shown represent the horizontal amplitude response as measured with a lens aperture  $f : 5,6$ .

## Modulation transfer characteristics

see Fig. 6

|                                     |       | XQ1520<br>XQ1520L | XQ1520R | XQ1520G | XQ1520B | XQ1523R<br>XQ1525R |    |
|-------------------------------------|-------|-------------------|---------|---------|---------|--------------------|----|
| Highlight signal<br>current         | $I_s$ | 300               | 150     | 300     | 150     | 150                | nA |
| Beam current                        | $I_b$ | 600               | 300     | 600     | 300     | 300                | nA |
| Modulation depth<br>at 400 TV lines |       |                   |         |         |         |                    |    |
| typ.                                |       | 55                | 50      | 55      | 60      | 55                 | %  |
| min.                                |       | 50                | 40      | 50      | 50      | 45                 | %  |

## Lag (typical values)

17

Light source with a colour temperature of 2856 K. Appropriate filter inserted in the light path for the chrominance tubes R, G and B

## LOW KEY CONDITIONS (without light bias)

|              | build-up lag          |        | decay lag             |        |
|--------------|-----------------------|--------|-----------------------|--------|
|              | $I_s/I_b = 20/300$ nA |        | $I_s/I_b = 20/300$ nA |        |
|              | 60 ms                 | 200 ms | 60 ms                 | 200 ms |
| XQ1520, L, G | 95%                   | ~ 100% | 9%                    | 3%     |
| XQ1520R      | 85%                   | ~ 100% | 13%                   | 3,5%   |
| XQ1520B      | 70%                   | ~ 100% | 15%                   | 5,5%   |
| XQ1523L      | 65%                   | ~ 100% | 15%                   | 5%     |
| XQ1525R      | 65%                   | ~ 100% | 15%                   | 5%     |
| XQ1525L      | 95%                   | ~ 100% | 10%                   | 3%     |

## LOW KEY CONDITIONS (with light bias)

18

Typical effect of light bias on build-up and decay lag under low key signal current and beam settings are shown in Figs 7 to 16.

Shading of light bias induced dark current

12,5%

18

MECHANICAL DATA

Dimensions in mm

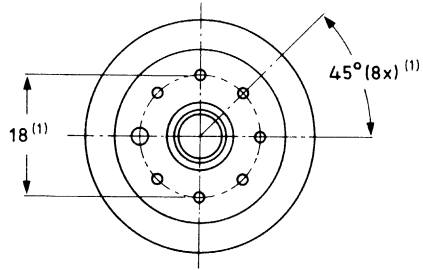
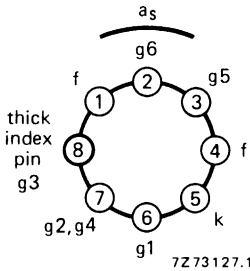
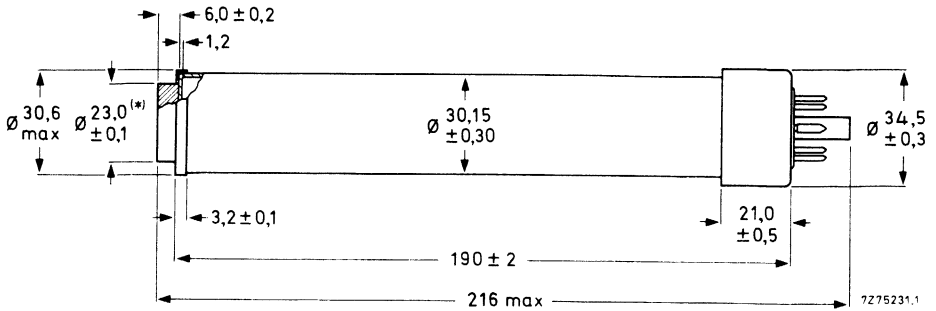

Mounting position: any

Mass: ≈ 100 g

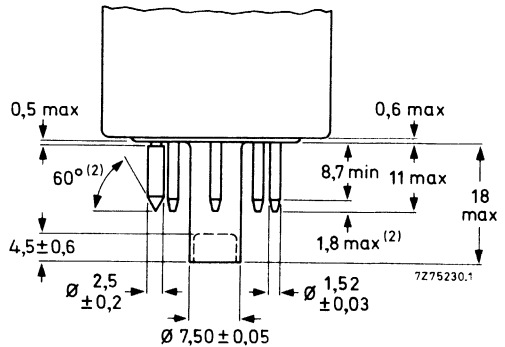

(\*) Distance between axis of anti-halation glass disc and geometrical centre of signal electrode ring, measured in plane of faceplate: max. 0,2 mm. Total glass thickness: 7,2 ± 0,2 mm.

(1) The base passes a flat gauge with a centre hole 8,230 ± 0,005 mm diameter and holes for passing the pins with the following diameters: 7 holes of 1,690 ± 0,005 mm and one hole of 2,950 ± 0,005 mm. The holes may deviate max. 0,01 mm from their true geometrical position. Thickness of gauge 7 mm.

(2) The ends of the pins are tapered and/or rounded but not brought to a sharp point.



NOTES, see also General Section

1. a. **Adjustable light bias.** The light bias lamp assembly as supplied with each tube, type 56106, fits in the metal tube cemented to the pumping stem of the tube. The tube and the light bias lamp assembly will fit properly in the sockets, type 56021 and 56025. The wires should be connected to a source, capable of supplying max. 110 mA at 5 V.  
Considerations and recommendations for the choice of such a source, depending on the application, are supplied with each tube. The light bias lamp projects its light via a blue-green transmitting filter on the pumping stem where it is conducted to the target to cause a bias illumination. The desired amount of light bias can be obtained by adjusting the current through the filament of the lamp. See also note 18.
- b. **Fixed light bias.** An adapter is supplied with each tube, connecting a small lamp via a calibrated series resistor to the heater pins. The heater supply should be stabilized at  $6,3 \pm 0,1$  V and be capable of supplying an additional current of 95 mA. The adapter is colour coded according to the application of the tube.
2. The tube can withstand short excursions up to 70 °C without damage or irreversible degradation in performance.
3. For short intervals. During storage the tube face shall be covered with the plastic hood provided; when the camera is idle the lens shall be capped, in stand-by also the beam will be cut-off.
4. The operating conditions and performance data quoted relate to operation of the tube in coil unit AT1130. See relevant data of deflection/focusing assemblies.
5. When the tube is to be used without ACT action, grid 3 should be connected to grids 2 and 4 and no ACT pulses should be applied to the cathode and grid 1. The performance of the tube will then be as described herein with the exception of the highlight handling.
6. a. For proper ACT action the d.c. voltage supply and/or pulse supply to the various electrodes should have sufficiently low impedance; see note 13.
- b. Video preamplifier: In the presence of highlights, peak signal currents of the order of 15 to 45  $\mu$ A may be offered to the preamplifier during flyback. Special measures have to be taken in the preamplifier to prevent temporary overloading.
7. a. Read-out mode: Defined as the operating conditions during the active line scan (full line period-line blanking interval). For the CCIR system this will amount to  $64 \mu\text{s} - 12 \mu\text{s} = 52 \mu\text{s}$ .
- b. ACT mode: Defined as the operating conditions during that part of the line blanking interval during which the ACT electrode gun is fully operative. The ACT interval is equal to or slightly within the line flyback time.
8. Pulse timing (CCIR) and amplitudes for ACT action: (blanking applied to grid 1, see note 12)
  - a. For proper operation and setting up of the ACT electron gun three electrodes have to be pulsed:
    - Cathode: A positive-going pulse,  $V_{kp}$ , with an adjustable amplitude of 0 to 20 V. This pulse can be chosen to coincide with the camera blanking period (approx. 11  $\mu\text{s}$ ). The amplitude of this pulse determines the ACT cutting level and may in general be preset to 7; 3,5; 7 and 3,5 V, for black/white, R, G, and B application respectively. An amplitude of 20 V should be available to preset the  $I_g/I_D$ ; see note 10.
    - Grid 1: A positive-going pulse,  $V_{g1p}$ , with such an amplitude that during the ACT mode the grid 1 bias is effectively reduced by 25 V, ( $V_{g1p} = 25 \text{ V} + V_{kp}$ ), to produce an extra amount of cathode current. The duration of this pulse should be so chosen that it is just within the flyback period (approx. 5  $\mu\text{s}$ ).

- Grid 3: A negative-going pulse,  $V_{g3p}$ , timing and duration coinciding with  $V_{g1p}$ , with: either an adjustable amplitude and superimposed on a fixed grid 3 voltage of 250 to 300 V, or with fixed amplitude and superimposed on an adjustable grid 3 voltage of 250 to 300 V, in either case, adjusted to result in a grid 3 voltage of 8,5 V with respect to the cathode voltage during the ACT mode. This pulse ensures that an adequate amount of beam current is drawn from the cathode current.

b. A suggested pulse timing and amplitude diagram is shown in Fig. 1.

9. Operation with ACT at  $V_{g6} > 750$  V is not recommended since this may introduce dark current.
10. Adjusted with the ACT made inoperative, e.g. by setting the cathode pulse to 20 V. The control grid voltage is adjusted to produce a beam current just sufficient to allow a peak signal current of twice the typical value,  $I_{sp}$ , as observed and measured on a waveform oscilloscope. This amount of beam current is termed  $I_{bp}$ .  $I_b$  is set at 300 nA for R and B tubes and at 600 nA for L and G tubes.

N.B. The signal current,  $I_s$ , and the beam current,  $I_b$ , conditions quoted with the performance figures for e.g. lag relate to measurements with an integrating instrument connected in the signal electrode lead and a uniform illuminance on the scanned area. The corresponding peak currents,  $I_{sp}$  and  $I_{bp}$ , as measured on a waveform oscilloscope will be a factor  $\alpha$  larger.

$\alpha = 100/100 - \beta$ ;  $\beta$  being the total blanking time in %; for CCIR system  $\alpha = 1,3$ .

11. Typical faceplate illumination level for the XQ1520 and XQ1520L to produce 300 nA signal current will be approx. 3,5 lx. The signal currents stated for the colour tubes R, G and B will be obtained with an incident white light level (2856 K) on the filter of approx. 8,5 lx. These figures are based on the filters described in note 14. For filter BG12, however, a thickness of 1 mm is chosen.
12. Blanking can also be applied to the cathode:
  - without ACT action; required cathode pulse approx. 25 V
  - with ACT action; timing, polarity and amplitudes of the ACT pulses will have to be adapted.
13. The d.c. voltage supply and/or pulse supply to these electrodes should have a sufficiently low impedance to prevent distortion caused by the peak currents drawn during the ACT mode. These peak currents may amount to:

|               |             |
|---------------|-------------|
| cathode       | 2 mA        |
| grid 1        | 0 mA        |
| grids 2 and 4 | 1 mA        |
| grid 3        | 150 $\mu$ A |
| grid 5        | 300 $\mu$ A |
| grid 6        | 300 $\mu$ A |

The cathode impedance should preferably be chosen  $\leq 300 \Omega$ .

14. Measuring conditions: illuminance level 4,54 lx at a colour temperature of 2856 K and the appropriate filter inserted in the light path. The signal current obtained in nA is a measure of the colour sensitivity expressed in  $\mu$ A per lumen of white light before the filter. Filters used are:

|                  |             |       |           |      |
|------------------|-------------|-------|-----------|------|
| XQ1520R, XQ1525R | Schott      | OG570 | thickness | 3 mm |
| XQ1520G          | Schott      | VG9   | thickness | 1 mm |
| XQ1520B          | Schott      | BG12  | thickness | 3 mm |
| XQ1523R          | Schott      | OG570 | thickness | 3 mm |
|                  | and Calflex | B1/K1 |           |      |

For transmission curves see General Section.

15. With pulses applied as indicated in note 8 the tube will properly handle a highlight with a diameter of 10% of picture height and with a luminance corresponding to 32 times peak signal white,  $I_{sp}$ .

16. As measured with a 50 mm Leitz Summicron lens having a sine response of approximately 85% at 400 TV lines at  $f : 5,6$  and the appropriate filter inserted in the light path. The horizontal amplitude response can be raised by means of suitable correction circuits, which affect neither the vertical resolution nor the limiting resolution.
17. **Build-up lag**  
After 10 s of darkness. The figures are typical percentages of the ultimate signal current obtained 60 ms and 200 ms, respectively, after the introduction of the illuminance.
- Decay lag**  
After the target has been illuminated for at least 5 s. The figures represent typical signals in percentages of the original signal current 60 ms and 200 ms, respectively, after removal of the illuminance.
18. A reduction of lag, especially under low key conditions is obtained when light bias is applied. Infrared light with a wavelength  $> 600$  nm in the light bias should be avoided.
- a. For monochrome operation a light bias corresponding to 4,5 nA dark current is usually adequate for excellent speed of response. The adapter as supplied with the tube will produce a fixed light bias in the order of this magnitude.
- b. *Adjustable* light bias (colour camera).  
In a colour camera the speeds of response of the tubes can be balanced by adjusting the amount of light bias per tube.  
In a 3-tube colour camera for instance it is recommended to first adjust the tubes to their normal highlight signal current and beam current settings and then point the camera at a dark scene comprising a metronome. The moving hand of the metronome carries a small white square. The illuminance should be chosen such that the square produces a peak signal of approximately 50 nA in the green chrominance channel.  
A maximum of 3 nA artificial dark current shall then be introduced in the green chrominance tube. Subsequently light bias shall be applied to the tubes in the red and blue channels until the lag of the three tubes is neutralized.
- c. *Fixed* light bias (colour camera).  
A typical setting for correct speeds of response in a 3-tube colour camera would be approximately 3 nA(p) (R), 2 nA(p) (G) and 3,5 nA(p) (B). The adapters as supplied with the tubes will produce fixed bias of the same magnitude.
19. Deviation of the level of any of the four corners, i.e. 10% inwards in H and V direction from the level in the picture centre. With the settings suggested in note 18 black shading compensation in the camera video processing amplifier will not normally be required. Further improvement in lag can be obtained by applying still higher light bias levels. It may then be necessary to use black shading compensation in the video processing amplifier.

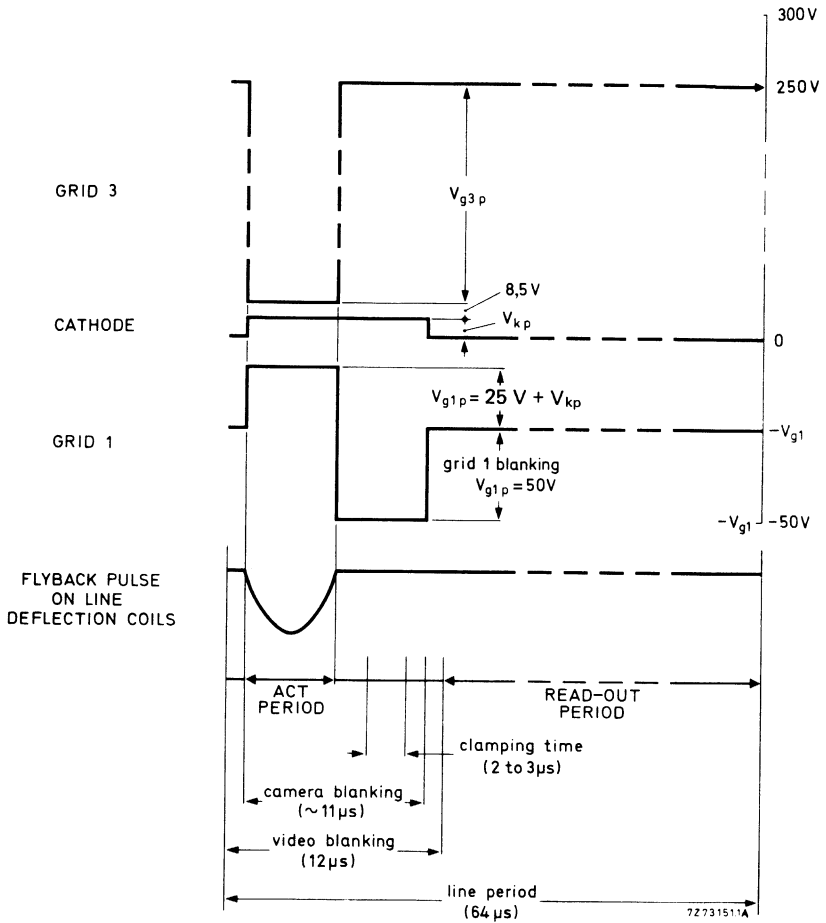

Fig. 1.

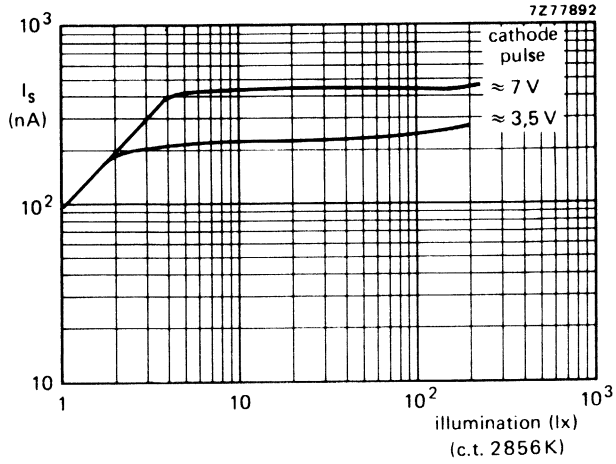

Fig. 2 Typical light transfer characteristics with ACT applied.

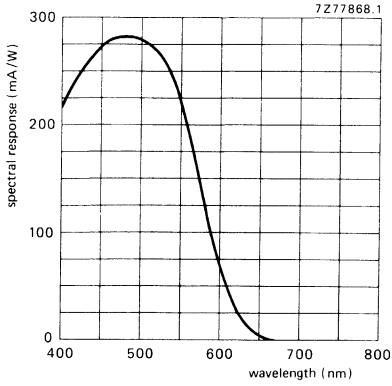

Fig. 3 Typical spectral response for XQ1520, L, G, B.

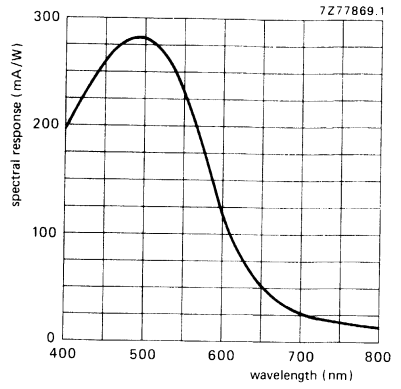

Fig. 4 Typical spectral response for XQ1523R.

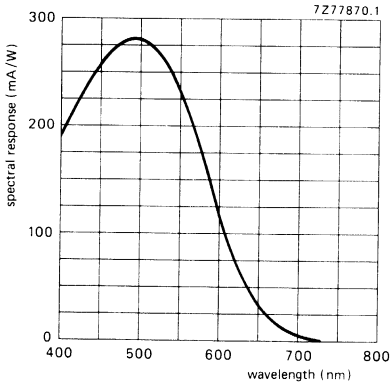

Fig. 5 Typical spectral response for XQ1525R.

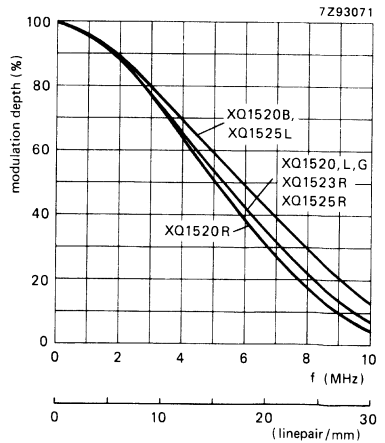

Fig. 6 Typical square-wave response curves.

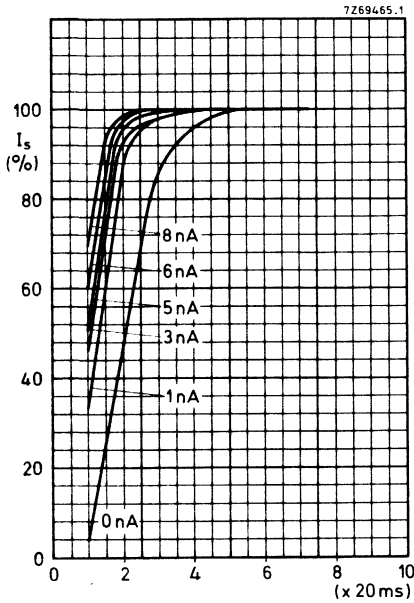

Fig. 7.

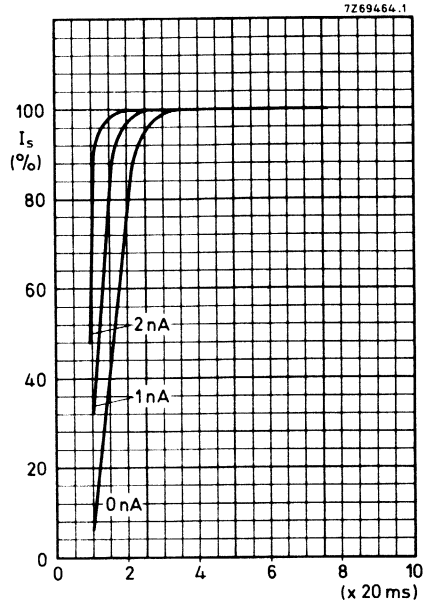
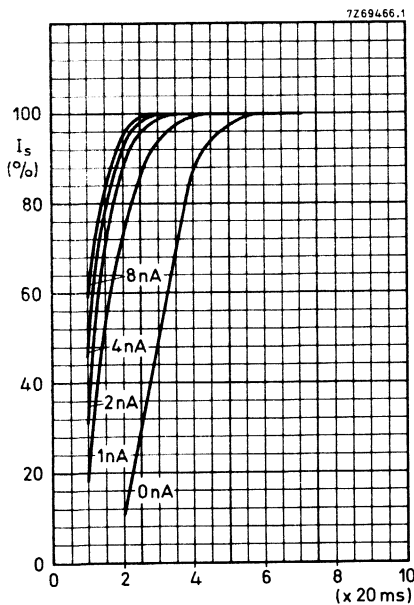

Fig. 8.



**Build-up lag (note 17)**

Light bias induced dark current as parameter.

Fig. 7, XQ1520R:  $I_s/I_b = 20/300$  nA

Fig. 8, XQ1520, XQ1520L, XQ1520G:  
 $I_s/I_b = 40/600$  nA

Fig. 9, XQ1520B:  $I_s/I_b = 20/300$  nA

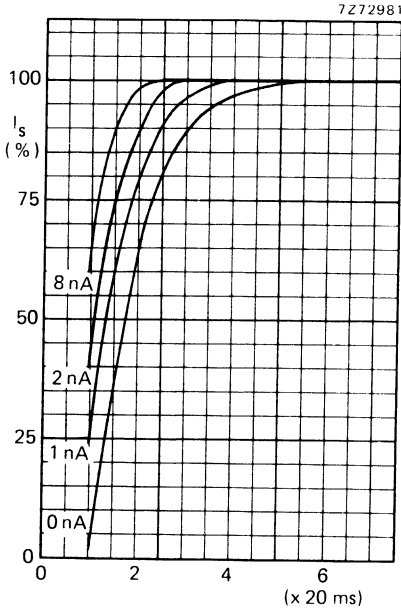

Fig. 10.

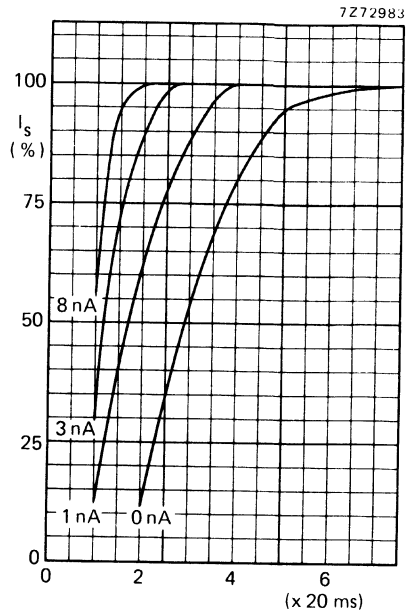

Fig. 11.

**Build-up lag** (see note 17)

Light bias induced dark current as parameter

Fig. 10, XQ1525L:  $I_s/I_b = 40/600 \text{ nA}$

Fig. 11, XQ1523R; XQ1525R:  $I_s/I_b = 20/300 \text{ nA}$



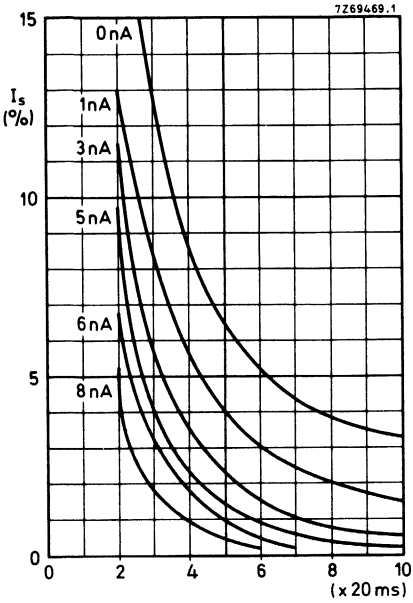

Fig. 12.

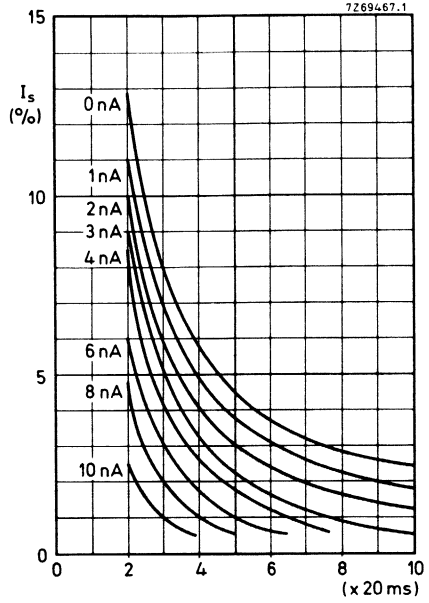

Fig. 13.

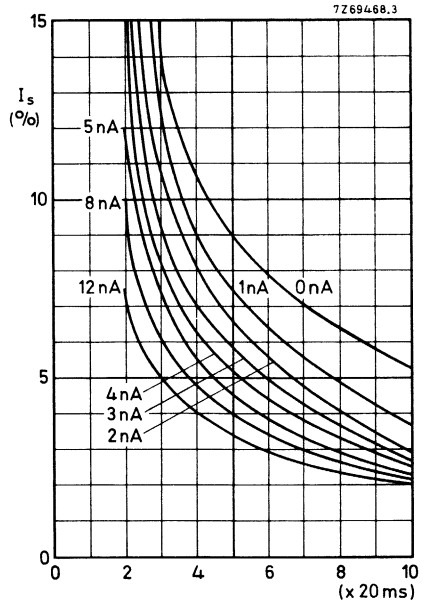

Fig. 14.

**Decay lag (note 17)**

Light bias induced dark current as parameter.

Fig. 12, XQ1520R:  $I_s/I_b = 20/300$  nA.

Fig. 13, XQ1520, XQ1520L, XQ1520G:  
 $I_s/I_b = 40/600$  nA.

Fig. 14, XQ1520B:  $I_s/I_b = 20/300$  nA.

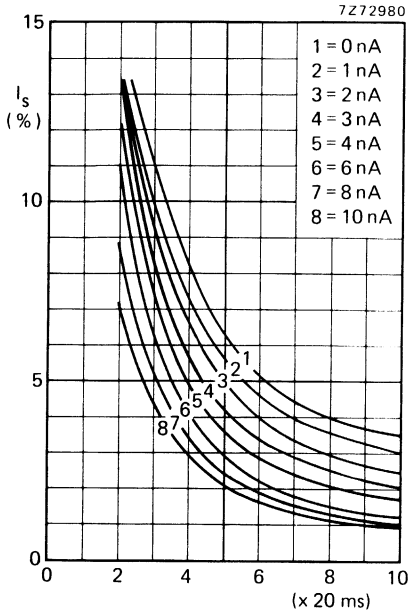

Fig. 15.

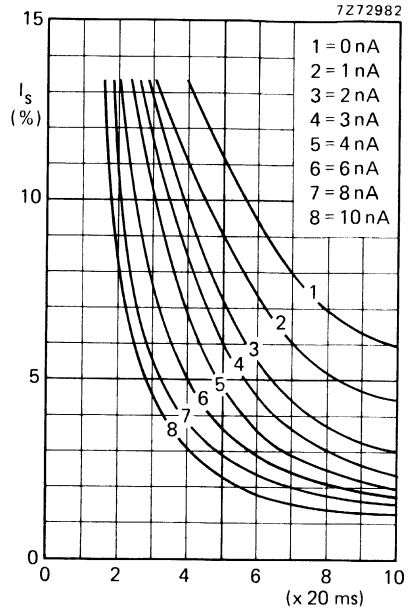

Fig. 16.

**Decay lag** (see note 17)

Light bias induced dark current as parameter

Fig. 15, XQ1525L:  $I_s/I_b = 40/600$  nA

Fig. 16, XQ1523R; XQ1525R:  $I_s/I_b = 20/300$  nA

### CAMERA TUBES

30 mm (1,2 inch) diameter Plumbicon® television camera tubes, with high resolution lead-oxide photoconductive target, for use in high quality monochrome or colour cameras for broadcast, educational or industrial applications.

The XQ3440 series comprises the following versions:

|         |   |
|---------|---|
| XQ3440  | for use in monochrome cameras                                   |
| XQ3440L | for use in the luminance channel of colour cameras              |
| XQ3440R | for use in the red channel                                      |
| XQ3440G | for use in the green channel                                    |
| XQ3440B | for use in the blue channel                                     |
| XQ3443R | for use in the red channel; extended red response               |
| XQ3445R | for use in the red channel; extended red response and IR filter |

Special features are:

- New photoconductive target for increased resolution
- "Diode" electron gun with high beam reserve for dynamic beam control (DBC) to minimize comet-tailing and blooming (notes 1 and 2)
- Provisions for light bias to reduce lag
- Low output capacitance (LOC) for high signal to noise ratio

#### QUICK REFERENCE DATA

|  |                                   |
|--|-----------------------------------|
| "Diode" electron gun                   |                                   |
| Diameter                               | 30 mm (1,2 inch)                  |
| Length                                 | approx. 215 mm                    |
| Provided with anti-halation glass disc |                                   |
| Focusing                               | magnetic                          |
| Deflection                             | magnetic                          |
| Useful target area (scanning area)     | 12,8 x 17,1 mm                    |
| Spectral response                      |                                   |
| max. at                                | approx. 500 nm                    |
| cut-off: XQ3440                        | approx. 650 nm                    |
| XQ3443                                 | approx. 850 to 950 nm             |
| XQ3445                                 | approx. 750 nm                    |
| Sensitivity                            |                                   |
| XQ3440, XQ3440L                        | typ. 375 $\mu\text{A}/\text{lmF}$ |
| XQ3440R                                | typ. 80 $\mu\text{A}/\text{lmF}$  |
| XQ3440G                                | typ. 150 $\mu\text{A}/\text{lmF}$ |
| XQ3440B                                | typ. 36 $\mu\text{A}/\text{lmF}$  |
| XQ3443R, XQ3445R                       | typ. 105 $\mu\text{A}/\text{lmF}$ |
| Resolution at 400 TV lines (5 MHz)     |                                   |
| XQ3440, XQ3440L                        | typ. 65 %                         |
| XQ3440R                                | typ. 55 %                         |
| XQ3440G                                | typ. 65 %                         |
| XQ3440B                                | typ. 70 %                         |
| XQ3443R, XQ3445R                       | typ. 60 %                         |
| Heater                                 | 6,3 V, 190 mA                     |

® Registered trademark for television camera tubes.

## OPTICAL DATA

notes

|   |                |
|---|----------------|
| Quality rectangle on photoconductive target (aspect ratio 3 : 4)  | 12,8 x 17,1 mm |
| Orientation of image on target:<br>For correct orientation of the image on the target the vertical scan should be essentially parallel to the plane passing through the tube axis and the marker line on the protecting sleeve at the base. |                |
| Faceplate   |                |
| Thickness   | 1,2 ± 0,1 mm   |
| Refractive index  | n = 1,49       |
| Anti-halation glass disc  |                |
| Thickness   | 6 ± 0,2 mm     |
| Refractive index  | n = 1,52       |
| XQ3445R is provided with an infrared reflecting filter  |                |

## ACCESSORIES

|  |                     |
|--|---------------------|
| Socket   | type 56021 or 56025 |
| Deflection and focusing coil unit, rear loading: |                     |
| Black/white                                      | type AT1131S        |
| Colour   | type AT1131T        |
| Mask for flare reduction                         | type 56029          |
| For adjustable light bias: lamp in holder        | type 56106      3   |
| Adapters for fixed light bias R tubes            | type 56123          |
| Adapters for fixed light bias G, L tubes         | type 56124          |
| Adapters for fixed light bias B tubes            | type 56125          |

## ELECTRICAL DATA

|  |            |              |
|--|------------|--------------|
| Deflection   |            | magnetic     |
| Focusing   |            | magnetic     |
| Heating, indirect by a.c. or d.c.; parallel supply   |            |              |
| Heater voltage   | $V_f$      | 6,3 V ± 5%   |
| Heater current at $V_f = 6,3$ V  | $I_f$ nom. | 190 mA       |
| The heater voltage must not exceed an r.m.s. value of 9,5 V. For optimum performance (lifetime and registration stability) stabilization of the heater voltage is recommended. |            |              |
| Capacitance  |            |              |
| Signal electrode to all  | $C_{as}$   | approx. 3 pF |
| This capacitance, which is effectively the output impedance, increases when the tube is inserted in the coil unit.   |            |              |

**LIMITING VALUES** (Absolute maximum rating system)

notes

Unless otherwise stated, all voltages are referred to the cathode.

|  |             |      |              |  |
|--|-------------|------|--------------|--|
| Signal electrode voltage   | $V_{as}$    | max. | 50 V         |  |
| Grid 4 voltage   | $V_{g4}$    | max. | 1100 V       |  |
| Grid 3 voltage   | $V_{g3}$    | max. | 800 V        |  |
| Voltage between grid 4 and grid 3                                  | $V_{g4/g3}$ | max. | 350 V        |  |
| Grid 2 voltage   | $V_{g2}$    | max. | 350 V        |  |
| Grid 1 voltage,  |             |      |              |  |
| positive   | $V_{g1}$    | max. | 25 V         |  |
| negative   | $-V_{g1}$   | max. | 200 V        |  |
| Grid 1 current (approx. $I_k$ current)                             | $I_{g1}$    | max. | 7 mA         |  |
| Grid 1 current (peak current with DBC)                             | $I_{g1p}$   | max. | 10 mA        |  |
| Cathode to heater voltage  |             |      |              |  |
| positive peak  | $V_{kfp}$   | max. | 50 V         |  |
| negative peak  | $-V_{kfp}$  | max. | 50 V         |  |
| Cathode heating time before drawing cathode current                | $t_h$       | min. | 1 min        |  |
| External resistance between cathode and heater at $V_{kfp} > 10$ V | $R_{kf}$    | min. | 2 k $\Omega$ |  |

DEVELOPMENT DATA

|  |           |      |        |   |
|--|-----------|------|--------|---|
| Ambient temperature, storage and operation   | $T_{amb}$ | max. | 50 °C  | 4 |
|  |           | min. | -30 °C |   |
| Faceplate temperature, storage and operation | $T$       | max. | 50 °C  |   |
|  |           | min. | -30 °C |   |
| Faceplate illuminance                        | $E$       | max. | 500 lx | 5 |

**OPERATING CONDITIONS** with ACT action

6

For a scanned area of 12,8 x 17,1 mm

|  |             |      |             |   |
|--|-------------|------|-------------|---|
| Cathode voltage                          | $V_k$       |      | 0 V         |   |
| Signal electrode voltage                 | $V_{as}$    |      | 45 V        |   |
| Beam current                             | $I_b$       | max. | 600 nA      | 7 |
| Grid 4 voltage                           | $V_{g4}$    |      | 675 V       |   |
| Grid 3 voltage                           | $V_{g3}$    |      | 600 V       |   |
| Grid 2 voltage                           | $V_{g2}$    |      | 300 V       |   |
| Grid 1 voltage for $I_b = 600$ nA        | $V_{g1}$    |      | + 8 V       | 7 |
| Blanking voltage on grid 1, peak to peak | $V_{g1p-p}$ |      | 25 V        |   |
| Faceplate illuminance                    |             |      | 0 to 10 lx  | 8 |
| Faceplate temperature                    |             |      | 20 to 45 °C |   |

**ELECTRON GUN CHARACTERISTICS**

Cut-off

Grid 1 voltage for cut-off at

 $V_{g2} = 300$  V, without blanking

Grid 1 voltage for normal beam setting

Blanking voltage, peak to peak

on grid 1

on cathode

Grid 1 current at normally

required beam currents

Grid 2 current at normally

required beam currents

|             |        |            |
|-------------|--------|------------|
| $V_{g1}$    |        | -10 to 0 V |
| $V_{g1w}$   | $\leq$ | 15 V       |
| $V_{g1p-p}$ |        | 25 V       |
| $V_{kp-p}$  |        | 25 V       |
| $I_{g1}$    | $\leq$ | 5 mA       |
| $I_{g2}$    | $\leq$ | 0,25 mA    |

## PERFORMANCE

notes

Dark current

XQ3440  $I_d \leq 1$  nA

XQ3443, XQ3445  $I_d \leq 2$  nA

Sensitivity at colour temperature of illuminance = 2856 K 9

XQ3440 min. 330 typ. 375  $\mu\text{A}/\text{lm}$

XQ3440R min. 70 typ. 80  $\mu\text{A}/\text{lmF}$

XQ3440G min. 120 typ. 150  $\mu\text{A}/\text{lmF}$

XQ3440B min. 32 typ. 36  $\mu\text{A}/\text{lmF}$

XQ3443R, XQ3445R min. 70 typ. 105  $\mu\text{A}/\text{lmF}$

Gamma of transfer characteristic 0,95 to 0,05

Spectral response, max. at approx. 500 nm

Spectral response, cut-off at approx. 650 to 950 nm

Spectral response curves see Figs 1, 2 and 3

Resolution 10

Modulation depth, i.e. uncompensated amplitude response at 400 TV lines at the centre of the picture.

|                                  | XQ3440<br>XQ3440L<br>XQ3440G | XQ3440R | XQ3443R<br>XQ3445R | XQ3440B |    |
|----------------------------------|------------------------------|---------|--------------------|---------|----|
| Highlight signal current $I_s$   | 300                          | 150     | 150                | 150     | nA |
| Beam current $I_b$               | 600                          | 300     | 300                | 300     | nA |
| Modulation depth at 400 TV lines |                              |         |                    |         |    |
| typ.                             | 65                           | 55      | 60                 | 70      | %  |
| min.                             | 55                           | 45      | 50                 | 60      | %  |

Modulation transfer characteristics: see Fig. 4

Lag (typical values, without light bias)

11, 12

Light source with a colour temperature of 2856 K. Appropriate filter inserted in the light path.

|                 | build-up lag          |        | decay lag             |        |
|-----------------|-----------------------|--------|-----------------------|--------|
|                 | $I_s/I_b = 20/300$ nA |        | $I_s/I_b = 20/300$ nA |        |
|                 | 60 ms                 | 200 ms | 60 ms                 | 200 ms |
| XQ3440, XQ3440L | 95%                   | ~ 100% | 9%                    | 3%     |
| XQ3440R         | 85%                   | ~ 100% | 13%                   | 3,5%   |
| XQ3440G         | 95%                   | ~ 100% | 10%                   | 3%     |
| XQ3440B         | 70%                   | ~ 100% | 13%                   | 5,5%   |
| XQ3443R         | 90%                   | ~ 100% | 15%                   | 3%     |
| XQ3445R         | 90%                   | ~ 100% | 15%                   | 4%     |

Shading of light bias induced dark current 12,5% 13

Highlight handling capability with DBC 4 lens stops 14

**MECHANICAL DATA**

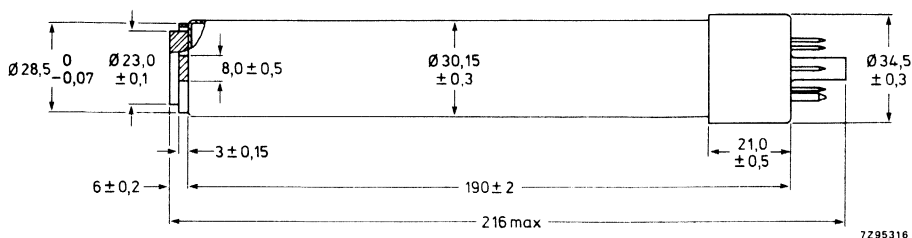

**DEVELOPMENT DATA**

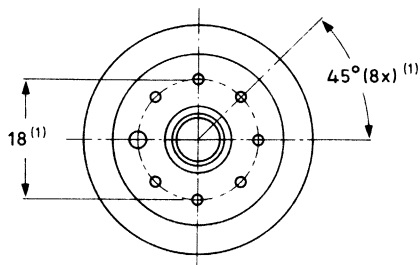
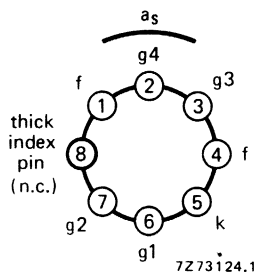

Mounting position: any

Mass: ≈ 100 g

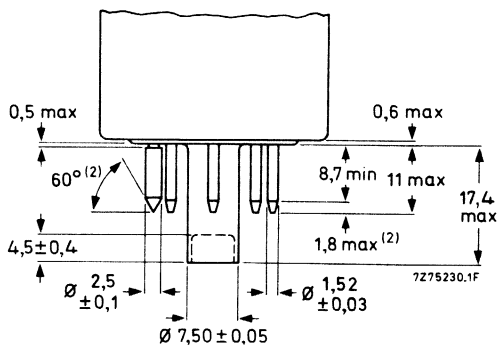

(\*) Distance between axis of centring ring and geometrical centre of mesh electrode ring, measured in plane of faceplate: max. 0,1 mm. Total glass thickness:  $7,2 \pm 0,2$  mm.

(1) The base passes a flat gauge with a centre hole  $8,230 \pm 0,005$  mm diameter and holes for passing the pins with the following diameters: 7 holes of  $1,690 \pm 0,005$  mm and one hole of  $2,950 \pm 0,005$  mm. The holes may deviate max. 0,01 mm from their true geometrical position. Thickness of gauge 7 mm.

(2) The ends of the pins are tapered and/or rounded but not brought to a sharp point.

**NOTES**, see also General Section

1. "Diode" electron gun is a triode gun operating in a diode mode, providing a very high beam reserve. Since the "Diode" gun operates with a positive grid 1 voltage, causing some grid current, cameras designed around XQ1410 tubes will require modification.

**N.B.**

Avoid continuous operation at high beam currents since this will shorten tube life. Full advantage of the high beam reserve to reduce comet-tailing and blooming can be made with DBC circuitry which, during highlights, feeds positive-going pulses derived from the video signal to grid 1, to increase the beam current momentarily.

2. The "diode" gun operates with a positive ( $\leq 15$  V) grid 1 voltage (adjusted for correct beam settings, see note 7), hence draws some grid 1 current:

without DBC:  $\leq 5$  mA (peak) with blanking

with DBC:  $\leq 10$  mA (peak) with blanking measured with oscilloscope.

The DBC circuitry should, in the case of highlights, supply positive-going pulses of 10 V above  $V_{g1w}$  (see note 7) and up to 10 mA peak to grid 1.

**N.B.**

Applying higher pulses than 10 V is not recommended since this will shorten tube life, impair resolution and may introduce oscillations.

3. a. **Adjustable light bias.** The light bias lamp assembly as supplied with each tube, type 56106, fits in the metal tube cemented to the pumping stem of the tube. The tube and the light bias lamp assembly will fit properly in the sockets, type 56021 and 56025. The wires should be connected to a source, capable of supplying max. 110 mA at 5 V.

Considerations and recommendations for the choice of such a source, depending on the application, are supplied with each tube. The light bias lamp projects its light via a blue-green transmitting filter on the pumping stem where it is conducted to the target to cause a bias illumination. The desired amount of light bias can be obtained by adjusting the current through the filament of the lamp. See also note 12.

- b. **Fixed light bias.** An adapter is supplied with each tube, connecting a small lamp via a calibrated series resistor to the heater pins. The heater supply should be stabilized at  $6,3 \pm 0,1$  V and be capable of supplying an additional current of 95 mA. The adapter is colour coded according to the application of the tube.

4. The tube can withstand short excursions up to 70 °C without damage or irreversible degradation in performance.
5. For short intervals. During storage the tube face shall be covered with the plastic hood provided; when the camera is idle the lens shall be capped, in stand-by also the beam will be cut-off.
6. The operating conditions and performance data quoted relate to operation of the tube in coil unit AT1131. See relevant data of deflection/focusing assemblies.
7. The beam current  $I_B$ , as obtained by adjusting the control grid (grid 1) voltage is set to 300 nA for R and B tubes, 600 nA for black and white, L and G tubes.  $I_B$  is not the actual current available in the scanning beam, but is defined as the maximum amount of signal current,  $I_S$ , that can be obtained with this beam.

In the performance figures for  $I_{ag}$ , the signal current and beam current conditions are given, e.g. as  $I_S/I_B = 20/300$  nA. This means: with a signal current of 20 nA and a beam setting which just allows a signal current of 300 nA.

The signal currents are measured with an integrating instrument connected in the signal electrode lead and a uniform illumination of the scanned area.

The peak signal currents as measured on a waveform oscilloscope will be a factor  $\alpha$  larger.

$$\alpha = 100/100-\beta;$$

$\beta$  being the total blanking time in %, for the CCIR system  $\alpha = 1,3$ .



8. Typical faceplate illumination level for the XQ3440 and XQ3440L to produce 300 nA signal current will be approx. 3,5 lx. The signal currents stated for the colour tubes R, G and B will be obtained with an incident white light level (2856 K) on the filter of approx. 9 lx. These figures are based on the filters described in note 9. For filter BG12, however, a thickness of 1 mm is chosen.
9. Measuring conditions: illuminance level 4,54 lx at a colour temperature of 2856 K and the appropriate filter inserted in the light path. The signal current obtained in nA is a measure of the colour sensitivity expressed in  $\mu\text{A}$  per lumen of white light before the filter. Filters used are:

|                  |             |       |           |      |
|------------------|-------------|-------|-----------|------|
| XQ3440R, XQ3445R | Schott      | OG570 | thickness | 3 mm |
| XQ3440G          | Schott      | VG9   | thickness | 1 mm |
| XQ3440B          | Schott      | BG12  | thickness | 3 mm |
| XQ3443R          | Schott      | OG570 | thickness | 3 mm |
|                  | and Calflex | B1/K1 |           |      |

For transmission curves see General Section.

10. As measured with a 50 mm Leitz Summicron lens having a sine response of approximately 85% at 400 TV lines at  $f : 5,6$  and the appropriate filter inserted in the light path. The horizontal amplitude response can be raised by means of suitable correction circuits, which affect neither the vertical resolution nor the limiting resolution.

#### 11. Build-up lag

After 10 s of darkness. The figures are typical percentages of the ultimate signal current obtained 60 ms and 200 ms, respectively, after the introduction of the illuminance.

#### Decay lag

After the target has been illuminated for at least 5 s. The figures represent typical signals in percentages of the original signal current 60 ms and 200 ms, respectively, after removal of the illuminance.

12. A reduction of lag, especially under low key conditions is obtained when light bias is applied. Infrared light with a wavelength  $> 600$  nm in the light bias should be avoided.
- For monochrome operation a light bias corresponding to 5 nA dark current is usually adequate for excellent speed of response.
  - In a colour camera the speeds of response of the tubes can be balanced by adjusting the amount of light bias per tube.  
In a 3-tube colour camera for instance it is recommended to first adjust the tubes to their normal highlight signal current and beam current settings and then point the camera at a dark scene comprising a metronome. The moving hand of the metronome carries a small white square. The illuminance should be chosen such that the square produces a peak signal of approximately 50 nA in the green chrominance channel. A maximum of 3 nA artificial dark current shall then be introduced in the green chrominance tube. Subsequently light bias shall be applied to the tubes in the red and blue channels until the lag of the three tubes is neutralized.
13. Deviation of the level of any of the four corners, i.e. 10% inwards in H and V direction from the level in the picture centre. With the settings suggested in note 12 black shading compensation in the camera video processing amplifier will not normally be required. Further improvement in lag can be obtained by applying still higher light bias levels. It may then be necessary to use black shading compensation in the video processing amplifier.
14. a. With DBC applied (see note 2) the tube will properly handle highlights with a diameter of 10% of the picture height and with a brightness corresponding to 16 times peak signal white,  $I_{sp}$ .
- b. The maximum peak signal currents in the case of highlights will be  $2,5 \mu\text{A}$ . Video preamplifiers should be designed to accommodate these.

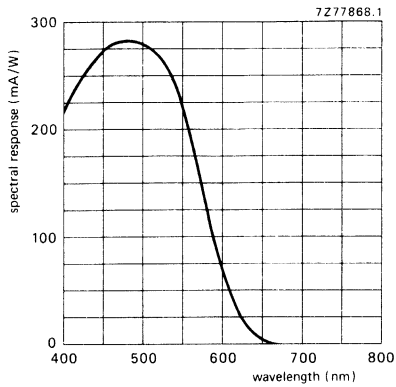

Fig. 1 Typical spectral response for XQ3440, L, G, B.

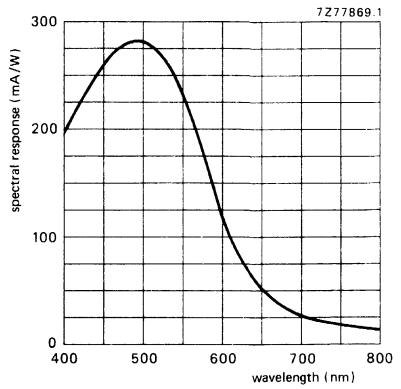

Fig. 2 Typical spectral response for XQ3443R.

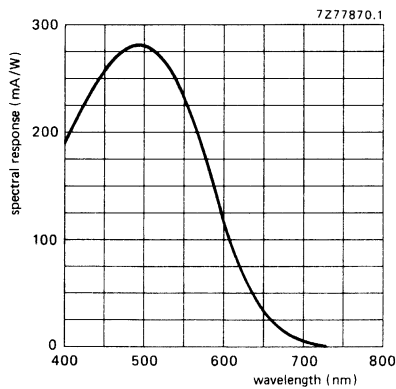

Fig. 3 Typical spectral response for XQ3445R.

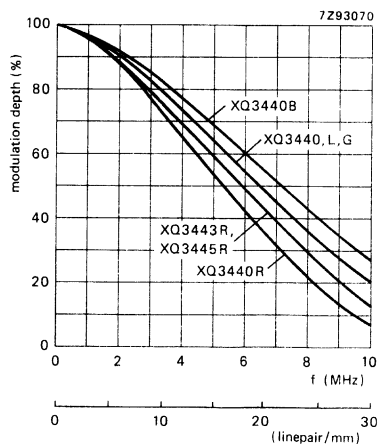

Fig. 4 Typical square wave response curves.

## CAMERA TUBES

Plumbicon®, 30 mm/45 mm diameter television camera tubes with very high resolution lead-oxide photoconductive target, exclusively intended for use with X-ray image intensifiers in medical equipment. Special features are:

- Large scan area,
- New photoconductive target for increased resolution,
- "Diode" electron gun for high beam reserve, improved beam acceptance, low lag,
- Low output capacitance for high signal-to-noise ratio.

## QUICK REFERENCE DATA

|  |                 |
|--|-----------------|
| "Diode" electron gun                     | notes 1, 2      |
| Diameter                                 | 47 mm/30 mm     |
| Length                                   | ≈ 216 mm        |
| Focusing                                 | magnetic        |
| Deflection                               | magnetic        |
| Useful target area; circle, diameter     | 26 mm           |
| Spectral response                        |                 |
| max. at                                  | ≈ 500 nm        |
| cut-off at                               | ≈ 850 to 950 nm |
| Sensitivity, typ.                        | 115 μA/lmF      |
| Modulation depth at 400 TV lines (5 MHz) | 95%             |
| Heater                                   | 6,3 V, 190 mA   |

## OPTICAL DATA

notes

Dimensions of quality area of target, circle of 26 mm diameter

3

Orientation of image on target.

For correct orientation of the image on the target the vertical scan should be essential parallel to the plane through the tube axis and the index pin.

Faceplate

|                  |         |
|------------------|---------|
| Thickness        | 3 mm    |
| Refractive index | 1,49 mm |

Anti halation glass disc

|                  |         |
|------------------|---------|
| Thickness        | 8 mm    |
| Refractive index | 1,52 mm |

## ACCESSORIES

|                                   |             |
|-----------------------------------|-------------|
| Socket                            | type 56021  |
| Deflection and focusing coil unit | type AT1107 |

® Registered Trade Mark for TV camera tube.

## ELECTRICAL DATA

**DEFLECTION** magnetic

**FOCUSING** magnetic

### HEATING

Indirect by a.c. or d.c.

Heater voltage  $V_f$  6,3 V  $\pm$  5 %

Heater current, nom.  $I_f$  190 mA

The heater voltage must never exceed 9,5 V (r.m.s.). For optimum performance stabilization of the heater voltage is recommended.

### CAPACITANCE

Signal electrode to all, typ.  $C_{as}$  5 pF

notes

This capacitance increases slightly when the tube is inserted in the coil unit.

### LIMITING VALUES (Absolute maximum rating system)

All voltages are referred to the cathode, unless otherwise stated.

|  |                 |              |                                     |   |
|--|-----------------|--------------|-------------------------------------|---|
| Signal electrode voltage   | $V_{as}$        | max.         | 50 V                                |   |
| Grid 4 (mesh) voltage  | $V_{g4}$        | max.         | 1100 V                              |   |
| Grid 3 voltage   | $V_{g3}$        | max.         | 800 V                               |   |
| Voltage between grid 4 and grid 3                                    | $V_{g4}/V_{g3}$ | max.         | 450 V                               | 5 |
| Grid 2 voltage   | $V_{g2}$        | max.         | 350 V                               |   |
| Grid 1 voltage positive  | $V_{g1}$        | max.         | 20 V                                |   |
| Grid 1 voltage negative  | $-V_{g1}$       | max.         | 125 V                               |   |
| Grid 1 current ( $\approx$ cathode current)                          | $I_{g1}$        | max.         | 10 mA                               | 4 |
| Cathode to heater voltage, positive peak                             | $V_{kfp}$       | max.         | 50 V                                |   |
| Cathode to heater voltage, negative peak                             | $-V_{kfp}$      | max.         | 125 V                               |   |
| Cathode heating time before drawing cathode current                  | $t_h$           | min.         | 1 min                               |   |
| External resistance between cathode and heater<br>at $V_{kf} > 10$ V | $R_{kf}$        | min.         | 2 k $\Omega$                        |   |
| Ambient temperature, storage and operation                           | $T_{amb}$       | max.<br>min. | 50 $^{\circ}$ C<br>-30 $^{\circ}$ C | 6 |
| Faceplate temperature, storage and operation                         | $T$             | max.<br>min. | 50 $^{\circ}$ C<br>-30 $^{\circ}$ C |   |
| Faceplate illuminance  | $E$             | max.         | 500 lx                              |   |

## OPERATING CONDITIONS AND PERFORMANCE

notes

## Conditions

|  |             |             |      |
|--|-------------|-------------|------|
| Cathode voltage                          | $V_k$       | 0 V         |      |
| Signal electrode voltage                 | $V_{as}$    | 45 V        |      |
| Beam current                             | $I_b$       |             | 8, 9 |
| Grid 4 voltage                           | $V_{g4}$    | 960 V       | 5    |
| Grid 3 voltage                           | $V_{g3}$    | 600 V       | 5    |
| Grid 2 voltage                           | $V_{g2}$    | 300 V       |      |
| Grid 1 voltage                           | $V_{g1}$    | 0 to 20 V   |      |
| Blanking voltage on grid 1, peak-to-peak | $V_{g1p-p}$ | 25 V        |      |
| Focusing and deflection coil currents    |             |             | 10   |
| Faceplate illuminance                    | E           | 0 to 10 lx  |      |
| Faceplate temperature                    | $T_{as}$    | 20 to 40 °C |      |

## ELECTRON GUN CHARACTERISTICS

## Cut-off

|   |             |            |  |
|---|-------------|------------|--|
| Grid 1 voltage for cut-off at $V_{g2} = 300$ V without blanking                 | $V_{g1}$    | -10 to 0 V |  |
| Grid 1 voltage for normal beam current  | $V_{g1w}$   | 9 V        |  |
| Blanking voltage with respect to $V_{g1w}$ , peak-to-peak, on grid 1 on cathode | $V_{g1p-p}$ | 25 V       |  |
|   | $V_{kp-p}$  | 25 V       |  |
| Grid 1 current at normally required beam currents                               | $I_{g1}$    | ≪ 5 mA     |  |
| Grid 2 current at normally required beam currents                               | $I_{g2}$    | ≪ 0,1 mA   |  |

## Performance

|   |          |                      |    |
|---|----------|----------------------|----|
| Dark current                                | $I_d$    | ≪ 3 nA               |    |
| Sensitivity at colour temperature of 2856 K |          | typ. 115 $\mu$ A/lmF | 11 |
| Sensitivity with P20 light source           |          | typ. 350 $\mu$ A/lm  |    |
| Peak signal current with E = 1 lx (P20)     | $I_{sp}$ | typ. 420 nA          | 12 |
| Peak signal current (26 mm dia.)            |          | 3500 nA              |    |
| Spectral response: max. response at         |          | ≈ 500 nm             |    |
| Spectral response: cut-off at               |          | 850 to 950 nm        |    |
| Spectral response curve                     |          | see Fig. 2           |    |
| Gamma of transfer characteristic            |          | 0,95 ± 0,05          |    |

**Resolution**

notes

Modulation depth, i.e. uncompensated amplitude response at 400 TV lines at centre of the picture.

|  | XQ4502           |            |
|--|------------------|------------|
| Highlight signal current $I_s$   | 400 nA           |            |
| Beam current $I_b$   | 800 nA           |            |
| Modulation depth at 400 TV lines (5 MHz) in % typ.<br>min.                                   | 95<br>90         |            |
| Limiting resolution  | 2500 TV lines    |            |
| Modulation transfer characteristic   | see Fig. 5       | 13         |
| Lag (typical values, no light bias applied)  |                  | 8,14,15,16 |
| Light source with a colour temperature of 2856 K. Appropriate filter inserted in light path. |                  |            |
| <b>Low key conditions</b> (percentage)   | see Figs 3 and 4 |            |

MECHANICAL DATA

Dimensions in mm

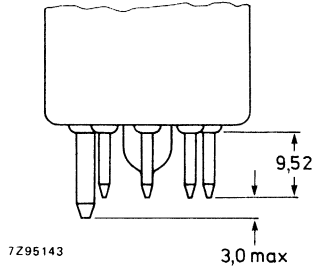
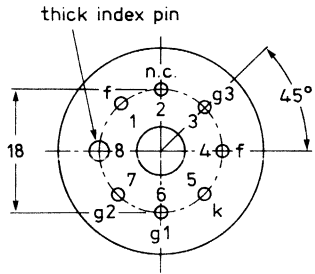
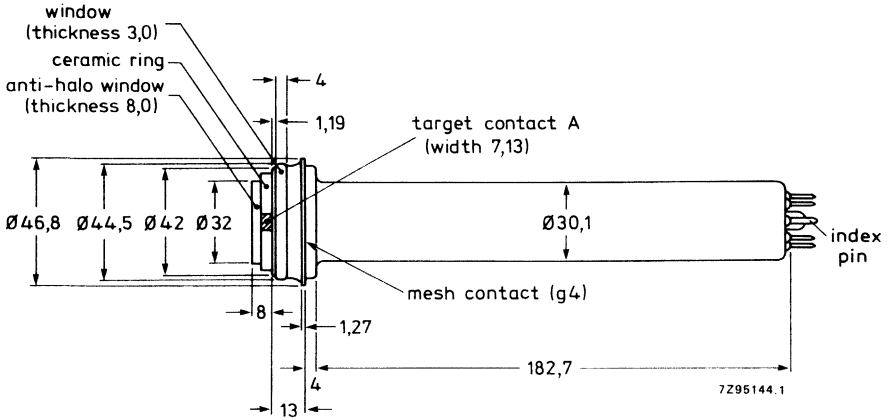

Mounting position: any

Mass  $\approx$  125 g

**NOTES**, see also General Section

1. Diode Gun is a triode gun operating in a diode mode, providing a very high beam reserve. Continuous operation with a high beam setting is to be avoided since this will shorten tube life. High  $I_b$  settings should be used under high light intensity conditions only, such as pulsed mode and rad mode. All other modes of operation should use normal  $I_b$  settings or have beam cut off.
2. The Diode Gun requires a positive grid 1 voltage, and draws some grid current.
3. Underscanning of the specified target area (26 mm diam.), or failure of scanning, should be avoided since damage to the target may occur. Cathode blanking should be used to provide a circular image. Video blanking could cause beam to scan mesh ring, with possible consequent degradation of tube life.
4. A current limiter must be incorporated to limit total cathode current to 10 mA maximum. Camera design should allow for 10 mA operation.
5. The optimum voltage ratio  $V_{g4}/V_{g3}$  to minimize beam landing errors (preferable  $< 1$  V) depends on the type of coil used. For type AT1107, a ratio of 1,7 is recommended. Under no circumstances should grid 4 (mesh) be allowed to operate at a voltage below that of grid 3 as this may damage the target.
6. The tube can withstand short excursions to 70 °C without any damage or irreversible degradation in performance.
7. This rating is for short intervals only. During storage the tube must be covered (a plastic hood is provided for this purpose) and when the camera is idle the lens must be capped. **If camera is in standby operation, the lens must be capped and the beams turned off.**
8. The beam current  $I_b$ , as obtained by adjusting the control grid voltage (grid 1), is set at 800 nA.  $I_b$  is not the total current available in the scanning beam, but is defined as the maximum amount of signal current,  $I_s$ , with this particular beam setting. In the performance figures, e.g. for resolution and lag, the signal current and beam current conditions are given e.g. as  $I_s/I_b = 400/800$  nA. This means: with signal current of 400 nA and a beam setting which just allows a signal current of 800 nA.  
N.B. The signal currents are measured with an integrating instrument connected in the signal electrode lead and a uniform illumination of the scanned area. The peak signal currents as measured on a waveform oscilloscope will be a factor  $\alpha$  larger. See note 12.
9. The maximum peak signal which the XQ4502 can handle is 4  $\mu$ A. Video amplifiers should be designed to accommodate this.
10. See published data of deflection/focusing assemblies. The direction of the current through the focusing coil should be chosen such that a north-seeking pole will be attracted at the faceplate end of the coil.
11. Measuring conditions: Illuminance level 3,1 lx at colour temperature of 2856 K. Filters Schott VG9 (1 mm) and Calflex B1/K1 inserted in the light path. For transmission curves see General Section.
12. The peak signal currents are measured on a waveform oscilloscope and with a uniform illumination on the 26 mm  $\phi$  target area. When measured with an integrating instrument connected in the signal-electrode lead the average signal currents will be smaller:
  - a. By a factor  $\alpha$  ( $\alpha = \frac{100-\beta}{100}$ ),  $\beta$  being the total blanking time in %: for the CCIR system  $\alpha$  amounts to 0,75.
  - b. By a factor  $\delta$ ,  $\delta$  being the ratio of the active target area (circle with 26 mm  $\phi$ ) to the area which would correspond with the adjusted scanning amplitudes (26 mm x 34,6 mm) this ratio amounts to  $\delta = 0,59$ .  
The total ratio of integrated signal current,  $I_s$ , to the peak signal current,  $I_{sp}$ , amount to  $\alpha \times \delta = 0,44$ .



13. As measured with a 50 mm Leitz Summicron lens having a sine response of approximately 96% at 8 lp/mm (400 TV lines at 26 mm dia.) at  $f : 5,6$ . The published 95% typ. is uncorrected. Tube resolution is higher.  
The horizontal amplitude response can be raised by means of suitable correction circuits, which affect neither the vertical resolution nor the limiting resolution.
14. Measured with 100 nA signal current and a beam current just sufficient to stabilize a signal current of 800 nA.
15. *Build-up lag.* After 10 seconds of complete darkness. Values and curves shown relating to build-up lag represent the typical percentages of the ultimate signal obtained as a function of time, after the illumination has been applied.
16. *Decay lag.* After a minimum of 5 seconds of illumination of the target. Values and curves shown relating to decay lag represent the residual signal currents in percentages of the original signal current as a function of time, after the illumination has been removed.

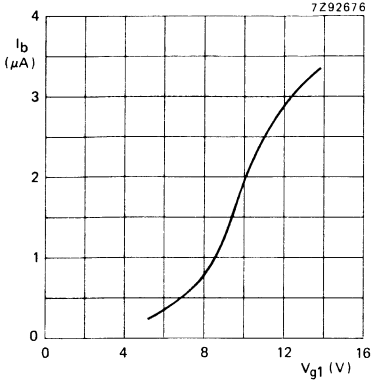

Fig. 1 Beam current versus grid 1 voltage, typical, see note 9.

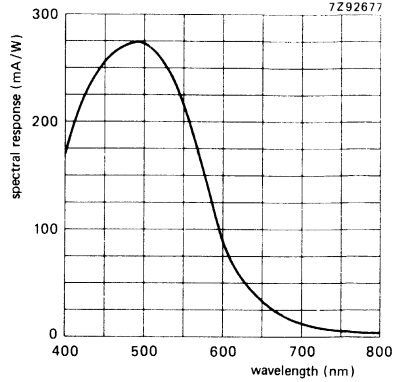

Fig. 2 Typical spectral response.

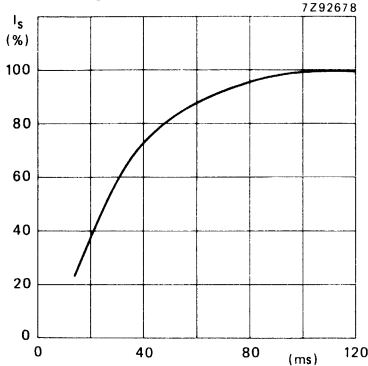

Fig. 3 Build-up lag, I<sub>s</sub>/I<sub>b</sub> = 100/800 nA without bias light. (Lag can be improved by using bias light).

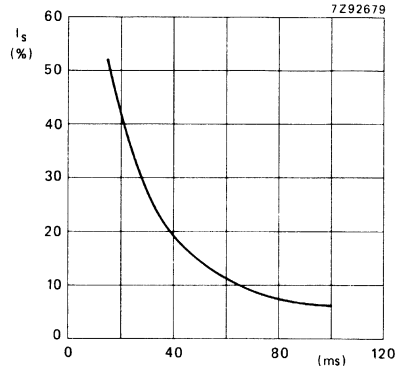

Fig. 4 Decay lag, I<sub>s</sub>/I<sub>b</sub> = 100/800 nA without bias light. (Lag can be improved by using bias light).

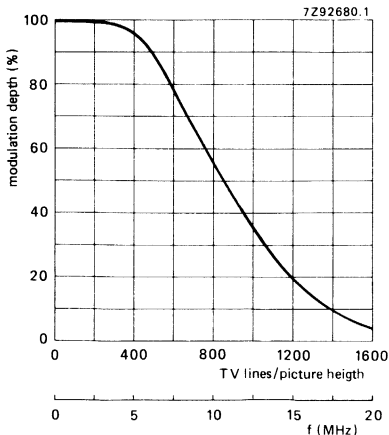

Fig. 5 Typical square wave response curve.

25,4 mm dia. PLUMBICON TUBES



## CAMERA TUBES

25,4 mm (1 in) diameter Plumbicon® television camera tubes, with standard resolution lead-oxide photoconductive target, for use in high quality monochrome or colour cameras for broadcast, educational or industrial applications.

The XQ1070 series comprises the following front loading versions:

|         |   |
|---------|---|
| XQ1070  | for use in monochrome cameras   |
| XQ1070L | for use in the luminance channel of colour cameras  |
| XQ1070R | for use in the red channel  |
| XQ1070G | for use in the green channel  |
| XQ1070B | for use in the blue channel   |
| XQ1071  | as XQ1070 series; only difference being the degree of freedom from blemishes on the target (industrial quality tubes) |
| XQ1073R | for use in the red channel; extended red response   |
| XQ1074  | as XQ1073. Industrial grade   |
| XQ1075R | for use in the red channel; extended red response and IR filter   |
| XQ1076  | as XQ1075. Industrial grade   |

Mechanical variants of the XQ1070 series are also available. Such variants are defined by a suffix as follows:

XQ . . . /02, R, G, B, L: rear loading versions with provision for internal light bias, target contact ring with 2 target contacts, metal sleeve on pumping stem to mount bias lamp,

XQ . . . /03, R, G, B, L: front loading versions with provision for internal light bias, metal ring target contact, metal sleeve on pumping stem to mount bias light lamp.

Special features are:

- Mechanically interchangeable with 1 inch Vidicon tubes with separate mesh.
- Same resolving power as the 30 mm tubes from the XQ1020 series.

## QUICK REFERENCE DATA

|  |                       |
|--|-----------------------|
| Separate mesh                          |                       |
| Diameter                               | 25,4 mm (1 inch)      |
| Length                                 | approx. 165 mm        |
| Provided with anti-halation glass disc |                       |
| Focusing                               | magnetic              |
| Deflection                             | magnetic              |
| Useful target area (scanning area)     | 9,6 x 12,8 mm         |
| Spectral response                      |                       |
| max. at                                | approx. 500 nm        |
| cut-off: XQ1070                        | approx. 650 nm        |
| XQ1073                                 | approx. 850 to 950 nm |
| XQ1075                                 | approx. 750 nm        |
| Sensitivity                            |                       |
| XQ1070, XQ1070L                        | typ. 400 $\mu$ A/lm   |
| XQ1070R                                | typ. 80 $\mu$ A/lmF   |
| XQ1070G                                | typ. 165 $\mu$ A/lmF  |
| XQ1070B                                | typ. 38 $\mu$ A/lmF   |
| XQ1073R, XQ1075R                       | typ. 115 $\mu$ A/lmF  |
| Resolution at 400 TV lines (5 MHz)     |                       |
| XQ1070, XQ1070L                        | typ. 40 %             |
| XQ1070R                                | typ. 35 %             |
| XQ1070G                                | typ. 40 %             |
| XQ1070B                                | typ. 50 %             |
| XQ1073R, XQ1075R                       | typ. 45 %             |
| Heater                                 | 6,3 V, 95 mA          |

® Registered trademark for television camera tubes.

## OPTICAL DATA

notes

|   |               |
|---|---------------|
| Quality rectangle on photoconductive target (aspect ratio 3 : 4)  | 9,6 x 12,8 mm |
| Orientation of image on target:<br>For correct orientation of the image on the target the vertical scan should be essentially parallel to the plane passing through the tube axis and the marker line on the protecting sleeve at the base. |               |
| Faceplate   |               |
| Thickness   | 1,2 ± 0,1 mm  |
| Refractive index  | n = 1,49      |
| Anti-halation glass disc provided with anti-reflective coating  |               |
| Thickness   | 5 ± 0,1 mm    |
| Refractive index  | n = 1,52      |
| XQ1075R is provided with infrared reflecting filter   |               |

## ACCESSORIES

|  |                          |               |
|--|--------------------------|---------------|
| Socket   | type 56098 or equivalent |               |
| Deflection and focusing coil unit:                 | rear loading             | front loading |
| Black/white  | type AT1126S             | AT1116/06S    |
| Colour   | type AT1126T             | AT1116/06T    |
| Mask for flare reduction                           | type 56028               |               |
| Light bias lamp in holder for versions /02 and /03 | type 56106               | 1             |

## ELECTRICAL DATA

|  |            |               |
|--|------------|---------------|
| Deflection   |            | magnetic      |
| Focusing   |            | magnetic      |
| Heating, indirect by a.c. or d.c.; parallel supply   |            |               |
| Heater voltage   | $V_f$      | 6,3 V ± 5%    |
| Heater current at $V_f = 6,3$ V  | $I_f$ nom. | 95 mA         |
| The heater voltage must not exceed an r.m.s. value of 9,5 V. For optimum performance (lifetime and registration stability) stabilization of the heater voltage is recommended. |            |               |
| Capacitance  |            |               |
| Signal electrode to all rear loading types   | $C_{as}$   | 2,5 to 3,5 pF |
| front loading types  | $C_{as}$   | 3 to 5 pF     |
| This capacitance, which is effectively the output impedance, increases when the tube is inserted in the coil unit.   |            |               |

**LIMITING VALUES** (Absolute maximum rating system)

notes

Unless otherwise stated, all voltages are referred to the cathode.

|   |             |      |              |   |
|---|-------------|------|--------------|---|
| Signal electrode voltage  | $V_{as}$    | max. | 50 V         |   |
| Grid 4 voltage  | $V_{g4}$    | max. | 1100 V       |   |
| Grid 3 voltage  | $V_{g3}$    | max. | 800 V        |   |
| Voltage between grid 4 and grid 3                                   | $V_{g4/g3}$ | max. | 450 V        |   |
| Grid 2 voltage  | $V_{g2}$    | max. | 350 V        |   |
| Grid 1 voltage  |             |      |              |   |
| positive  | $V_{g1}$    | max. | 0 V          |   |
| negative  | $-V_{g1}$   | max. | 125 V        |   |
| Cathode to heater voltage   |             |      |              |   |
| positive peak   | $V_{kfp}$   | max. | 125 V        |   |
| negative peak   | $-V_{kfp}$  | max. | 50 V         |   |
| Cathode heating time before drawing current                         | $t_h$       | min. | 1 min        |   |
| External resistance between cathode and heater at $-V_{kfp} > 10$ V | $R_{kf}$    | min. | 2 k $\Omega$ |   |
| Ambient temperature, storage and operation                          | $T_{amb}$   | max. | 50 °C        |   |
|   |             | min. | -30 °C       |   |
| Faceplate temperature, storage and operation                        | $T$         | max. | 50 °C        | 2 |
|   |             | min. | -30 °C       |   |
| Faceplate illuminance   | $E$         | max. | 500 lx       | 3 |

**OPERATING CONDITIONS**

For a scanned area of 9,6 x 12,8 mm

|  |             |             |   |
|--|-------------|-------------|---|
| Cathode voltage                          | $V_k$       | 0 V         | 4 |
| Signal electrode voltage                 | $V_{as}$    | 45 V        |   |
| Beam current                             | $I_b$       |             | 5 |
| Grid 4 voltage                           | $V_{g4}$    | 960 V       |   |
| Grid 3 voltage                           | $V_{g3}$    | 600 V       |   |
| Grid 2 voltage                           | $V_{g2}$    | 300 V       |   |
| Grid 1 voltage                           | $V_{g1}$    | V           | 5 |
| Blanking voltage on grid 1, peak to peak | $V_{g1p-p}$ | 50 V        |   |
| Faceplate illuminance                    | $E$         | 0 to 10 lx  | 6 |
| Faceplate temperature                    | $T$         | 20 to 45 °C | 2 |

**ELECTRON GUN CHARACTERISTICS**

Cut off

Grid 1 voltage for cut-off at  $V_{g2} = 300$  V, without blanking

Blanking voltage, peak to peak on grid 1

on cathode

Grid 2 current at normally required beam currents

|             |               |
|-------------|---------------|
| $V_{g1}$    | -35 to -100 V |
| $V_{g1p-p}$ | $50 \pm 10$ V |
| $V_{kp-p}$  | 25 V          |
| $I_{g2}$    | $\leq 0,5$ mA |

## PERFORMANCE

|   |                     |        |                              |       |
|---|---------------------|--------|------------------------------|-------|
| Dark current  | $I_d$               | $\leq$ | 3 nA                         | notes |
| Sensitivity at colour temperature of illuminance = 2856 K   |                     |        |                              | 7     |
| XQ1070, XQ1070L   | min. 375            | typ.   | 400 $\mu\text{A}/\text{lm}$  |       |
| XQ1070R   | min. 70             | typ.   | 80 $\mu\text{A}/\text{lmF}$  |       |
| XQ1070G   | min. 130            | typ.   | 165 $\mu\text{A}/\text{lmF}$ |       |
| XQ1070B   | min. 35             | typ.   | 38 $\mu\text{A}/\text{lmF}$  |       |
| XQ1073R, XQ1075R  | min. 75             | typ.   | 115 $\mu\text{A}/\text{lmF}$ |       |
| Gamma of transfer characteristics   |                     |        | 0,95 $\pm$ 0,05              |       |
| Spectral response, max. at  |                     |        | 500 nm                       |       |
| Spectral response, cut-off at   |                     |        | 650 to 950 nm                |       |
| Spectral response curves  | see Figs 1, 2 and 3 |        |                              |       |
| Resolution  |                     |        |                              | 8     |
| Modulation depth, i.e. uncompensated amplitude response at 400 TV lines at the centre of the picture. |                     |        |                              |       |

|                                  | XQ1070<br>XQ1070L<br>XQ1070G | XQ1070R | XQ1070B | XQ1073R<br>XQ1075R | 5  |
|----------------------------------|------------------------------|---------|---------|--------------------|----|
| Highlight signal current $I_s$   | 200                          | 100     | 100     | 100                | nA |
| Beam current $I_b$               | 400                          | 200     | 200     | 200                | nA |
| Modulation depth at 400 TV lines |                              |         |         |                    |    |
| typ.                             | 40                           | 35      | 50      | 40                 | %  |
| min.                             | 35                           | 30      | 45      | 35                 | %  |

Modulation transfer characteristics: see Figs 4 and 5

Lag (typical values, without light bias)

11, 12

Light source with a colour temperature of 2856 K. Appropriate filter inserted in the light path for the chrominance tubes R, G and B.

## LOW KEY CONDITIONS

|                  | build-up lag          |                | decay lag             |        |
|------------------|-----------------------|----------------|-----------------------|--------|
|                  | $I_s/I_b = 20/300$ nA |                | $I_s/I_b = 20/300$ nA |        |
|                  | 60 ms                 | 200 ms         | 60 ms                 | 200 ms |
| XQ1070, XQ1070L  | 95%                   | $\approx$ 100% | 9%                    | 3%     |
| XQ1070G          | 95%                   | $\approx$ 100% | 9%                    | 3%     |
| XQ1070R          | 90%                   | $\approx$ 100% | 11%                   | 4%     |
| XQ1070B          | 90%                   | $\approx$ 100% | 11%                   | 4%     |
| XQ1073R, XQ1075R | 85%                   | $\approx$ 100% | 11%                   | 4%     |

Shading of light bias induced dark current

12,5%



**MECHANICAL DATA**

Mounting position: any

Mass: approx. 60 g

Base: JEDEC E8-11, IEC 67-I-33a

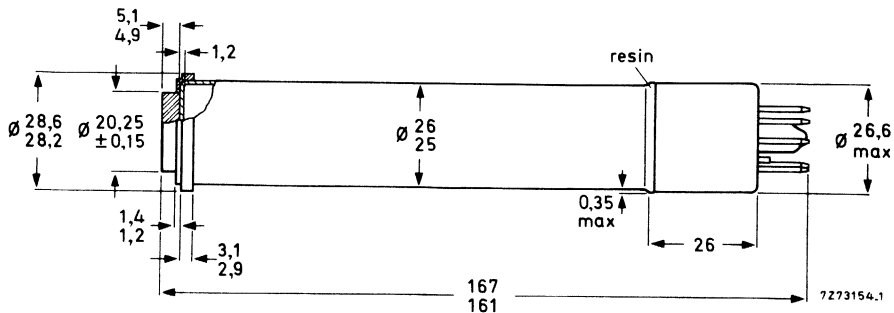

XQ1070

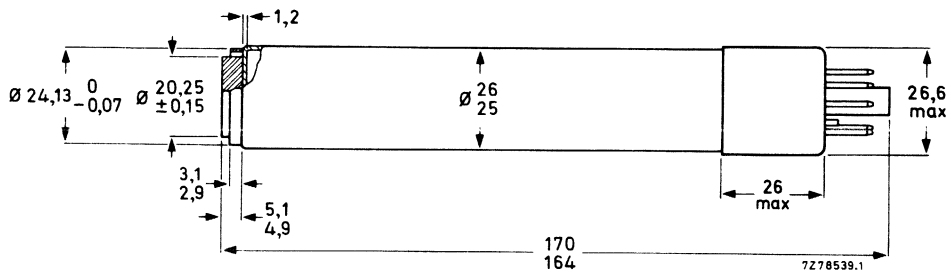

XQ1070/02

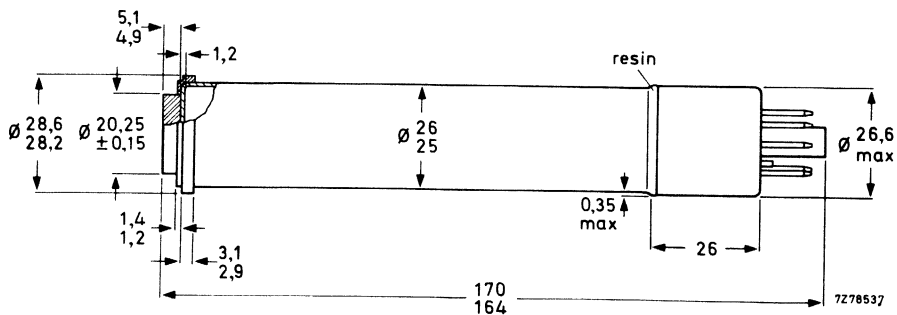

XQ1070/03

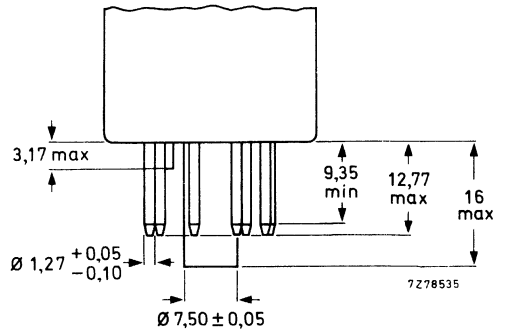
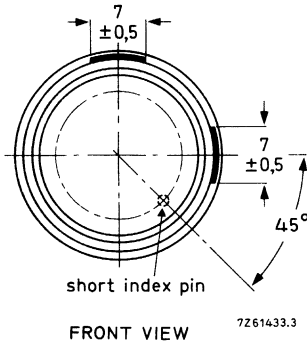
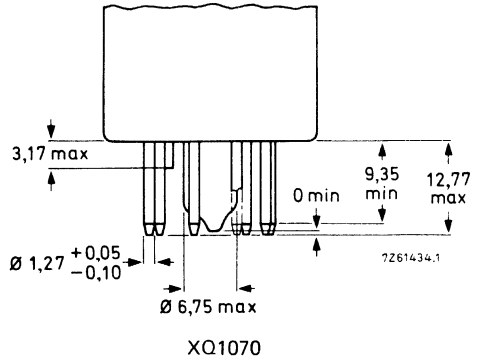
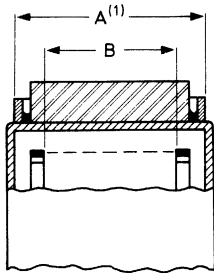
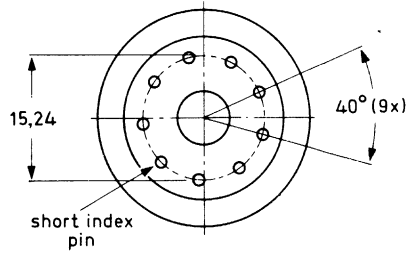
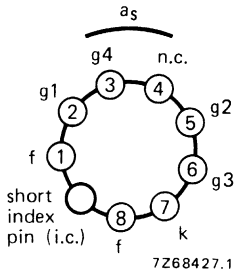

(1) The distance between the geometrical centres of diameter A of the reference ring and diameter B of the mesh electrode ring is  $< 100 \mu\text{m}$ .

XQ1070/02

NOTES, see also General Section.

1. For adjustable light bias in versions /02 and /03.

The light bias lamp assembly as supplied with each tube, type 56106, fits in the metal tube cemented to the pumping stem of the tube. The tube and the light bias lamp assembly will fit properly in the socket. The wires should be connected to a source, capable of supplying max. 110 mA at 5 V. Considerations and recommendations for the choice of such a source, depending on the application, are supplied with each tube. The light bias lamp projects its light via a blue-green transmitting filter on the pumping stem where it is conducted to the target to cause a bias illumination. The desired amount of light bias can be obtained by adjusting the current through the filament of the lamp. See also note 10.

- 2. The tube can withstand short excursions up to 70 °C without damage or irreversible degradation in performance.
- 3. For short intervals. During storage the tube face shall be covered with the plastic hood provided; when the camera is idle the lens shall be capped, in stand-by also the beam will be cut-off.
- 4. The operating conditions and performance data quoted relate to operation of the tube in coil units AT1116 or AT1126. See relevant data of deflection/focusing assemblies.
- 5. The beam current  $I_B$ , as obtained by adjusting the control grid (grid 1) voltage is set to 200 nA for R and B tubes, 400 nA for black and white, L and G tubes.  $I_B$  is not the actual current available in the scanning beam, but is defined as the maximum amount of signal current,  $I_S$ , that can be obtained with this beam.

In the performance figures for lag, the signal current and beam current conditions are given, e.g. as  $I_S/I_B = 20/300$  nA. This means: with a signal current of 20 nA and a beam setting which just allows a signal current of 300 nA.

N.B. The signal currents are measured with an integrating instrument connected in the signal electrode lead and a uniform illumination of the scanned area. The peak signal currents on a waveform oscilloscope will be a factor  $\alpha$  larger.

$$\alpha = \frac{100}{100-\beta} ;$$

$\beta$  being the total blanking time in %; for CCIR system  $\alpha = 1,3$ .

- 6. Typical faceplate illumination level for the XQ1070 and XQ1070L to produce 200 nA signal current will be approx. 4 lx. The signal currents stated for the colour tubes R, G and B will be obtained with an incident white light level (2856 K) on the filter of approx. 10 lx. These figures are based on the filters described in note 7. For filter BG12, however, a thickness of 1 mm is chosen.
- 7. Measuring conditions: illuminance level 4,54 lx at a colour temperature of 2856 K and the appropriate filter inserted in the light path. The signal current obtained in nA is a measure of the colour sensitivity expressed in  $\mu A$  per lumen of white light before the filter. Filters used are:

|                  |             |       |           |      |
|------------------|-------------|-------|-----------|------|
| XQ1070R, XQ1075R | Schott      | OG570 | thickness | 3 mm |
| XQ1070G          | Schott      | VG9   | thickness | 1 mm |
| XQ1070B          | Schott      | BG12  | thickness | 3 mm |
| XQ1073R          | Schott      | OG570 | thickness | 3 mm |
|                  | and Calflex | B1/K1 |           |      |

For transmission curves see General Section.

- 8. As measured with a 50 mm Leitz Summicron lens having a sine response of approximately 85% at 400 TV lines at  $f : 5,6$  and the appropriate filter inserted in the light path. The horizontal amplitude response can be raised by means of suitable correction circuits, which affect neither the vertical resolution nor the limiting resolution.

9. Build-up lag

After 10 s of darkness. The figures are typical percentages of the ultimate signal current obtained 60 ms and 200 ms, respectively, after the introduction of the illuminance.

Decay lag

After the target has been illuminated for at least 5 s. The figures represent typical signals in percentages of the original signal current 60 ms and 200 ms, respectively, after removal of the illuminance.

10. A reduction of lag, especially under low key conditions is obtained when light bias is applied in versions /02 and /03. Infrared light with a wavelength  $> 600$  nm in the light bias should be avoided.

- a. For monochrome operation a light bias corresponding to 2 to 3 nA extra dark current is usually adequate for excellent speed of response.
- b. In a colour camera the speeds of response of the tubes can be balanced by adjusting the amount of light bias per tube.

In a 3-tube colour camera, for instance, it is recommended first to adjust the tubes to their normal highlight signal current and beam current settings and then point the camera at a dark scene comprising a metronome. The moving hand of the metronome carries a small white square. The illuminance should be chosen such that the square produces a peak signal of approximately 50 nA in the green chrominance channel. A maximum of 3 nA artificial dark current shall then be introduced in green chrominance tube. Subsequently light bias shall be applied to the tubes in the red and blue channels until the lag of the three tubes is neutralized.

11. Deviation of the level of any of the four corners, i.e. 10% inwards in H and V direction from the level in the picture centre. With the settings suggested in note 10 black shading compensation in the camera video processing amplifier will not normally be required. Further improvement in lag can be obtained by applying still higher light bias levels. It may then be necessary to use black shading compensation in the video processing amplifier.

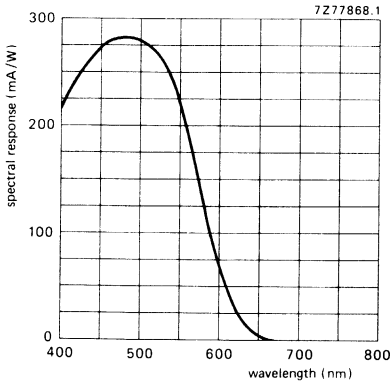

Fig. 1 Typical spectral response for XQ1070, L, G, B, R.

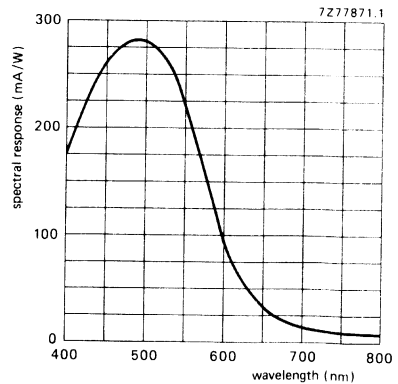

Fig. 2 Typical spectral response for XQ1073R.

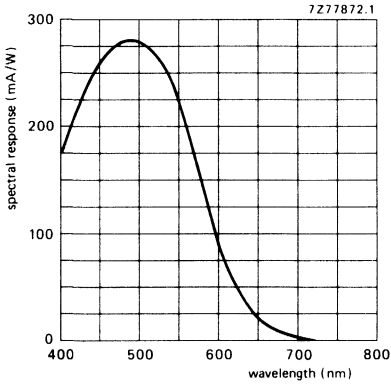

Fig. 3 Typical spectral response for XQ1075R.

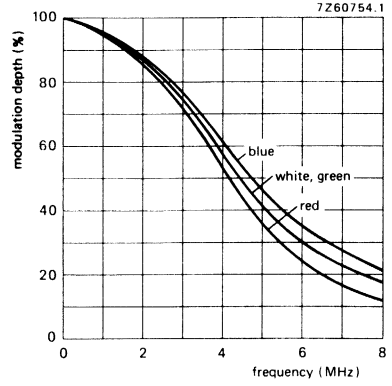

Fig. 4 Typical square-wave response curves for XQ1070.

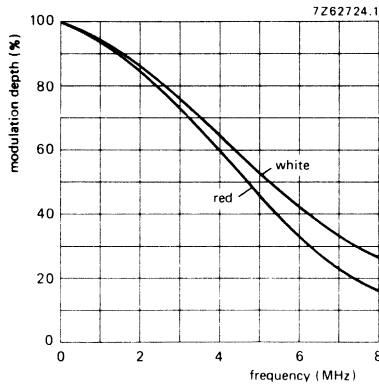

Fig. 5 Typical square-wave response curves for XQ1073 and XQ1075.



## CAMERA TUBE

25,4 mm (1 inch) diameter Plumbicon® television camera tube, with standard resolution lead-oxide photoconductive target. The XQ1072 is exclusively intended for use with X-ray image intensifiers with P20 output phosphor in medical equipment.

## QUICK REFERENCE DATA

|                                      |          |                  |
|--------------------------------------|----------|------------------|
| Diameter                             |          | 25,4 mm (1 inch) |
| Length                               | approx.  | 160 mm           |
| Focusing                             | magnetic |                  |
| Deflection                           | magnetic |                  |
| Useful target area, circle, diameter |          | 15 mm            |
| Spectral response                    |          |                  |
| max. at                              | approx.  | 500 nm           |
| cut-off:                             | approx.  | 650 nm           |
| Sensitivity, P20 light source        | typ.     | 500 $\mu$ A/lm   |
| Resolution at 13 lp/mm (5 MHz)       |          | 70 %             |
| Heater                               |          | 6,3 V, 95 mA     |

## OPTICAL DATA

|   |  |                  |
|---|--|------------------|
| Quality area on photoconductive target,<br>circle, diameter   |  | 15 mm            |
| Orientation of image on target:   |  |                  |
| For correct orientation of the image on the target the vertical scan should be essentially parallel to the plane passing through the tube axis and the marker line on the protecting sleeve at the base |  |                  |
| Faceplate   |  |                  |
| Thickness   |  | 1,2 $\pm$ 0,1 mm |
| Refractive index  |  | n = 1,49         |
| Without anti-halation glass disc  |  |                  |

## ACCESSORIES

|                                   |  |              |
|-----------------------------------|--|--------------|
| Socket                            |  | type 56098   |
| Deflection and focusing coil unit |  | type AT1116S |

## ELECTRICAL DATA

|  |            |                |
|--|------------|----------------|
| Deflection   |            | magnetic       |
| Focusing   |            | magnetic       |
| Heating, indirect by a.c. or d.c.;   |            |                |
| Heater voltage   | $V_f$      | 6,3 V $\pm$ 5% |
| Heater current at $V_f = 6,3$ V  | $I_f$ nom. | 95 mA          |
| The heater voltage must not exceed an r.m.s. value of 9,5 V. For optimum performance stabilization of the heater voltage is recommended. |            |                |
| Capacitance  |            |                |
| Signal electrode to all  | $C_{as}$   | 3 to 5 pF      |
| This capacitance, which is effectively the output impedance, increases when the tube is inserted in the coil unit.                       |            |                |

® Registered trademark for television camera tubes.

**LIMITING VALUES** (Absolute maximum rating system)

notes

Unless otherwise stated, all voltages are referred to the cathode.

|  |             |      |              |   |
|--|-------------|------|--------------|---|
| Signal electrode voltage                     | $V_{as}$    | max. | 50 V         |   |
| Grid 4 voltage                               | $V_{g4}$    | max. | 1100 V       |   |
| Grid 3 voltage                               | $V_{g3}$    | max. | 800 V        |   |
| Voltage between grid 4 and grid 3            | $V_{g4/g3}$ | max. | 450 V        |   |
| Grid 2 voltage                               | $V_{g2}$    | max. | 350 V        |   |
| Grid 2 dissipation                           | $W_{g2}$    | max. | 1 W          |   |
| Grid 1 voltage,                              |             |      |              |   |
| positive                                     | $V_{g1}$    | max. | 0 V          |   |
| negative                                     | $-V_{g1}$   | max. | 125 V        |   |
| Cathode to heater voltage                    |             |      |              |   |
| positive peak                                | $V_{kfp}$   | max. | 125 V        |   |
| negative peak                                | $-V_{kfp}$  | max. | 50 V         |   |
| Cathode heating time before drawing          |             |      |              |   |
| cathode current                              | $t_h$       | min. | 1 min        |   |
| External resistance between cathode          |             |      |              |   |
| and heater at $-V_{kfp} > 10$ V              | $R_{kf}$    | min. | 2 k $\Omega$ |   |
| Ambient temperature, storage and operation   | $T_{amb}$   | max. | 50 °C        |   |
|  |             | min. | 30 °C        |   |
| Faceplate temperature, storage and operation | $T$         | max. | 50 °C        | 1 |
|  |             | min. | 30 °C        |   |
| Faceplate illuminance                        | $E$         | max. | 500 lx       | 2 |

**OPERATING CONDITIONS**

For a scanned circular area with a diameter of 15 mm

|  |             |               |             |   |
|--|-------------|---------------|-------------|---|
| Cathode voltage                          | $V_k$       | 0 V           |             | 3 |
| Signal electrode voltage                 | $V_{as}$    | 45 V          |             |   |
| Beam current                             | $I_b$       |               |             | 4 |
| Grid 4 voltage                           | $V_{g4}$    | 960 V         |             |   |
| Grid 3 voltage                           | $V_{g3}$    | 600 V         |             |   |
| Grid 2 voltage                           | $V_{g2}$    | 300 V         |             |   |
| Grid 1 voltage                           | $V_{g1}$    | V             |             | 4 |
| Blanking voltage on grid 1, peak to peak | $V_{g1p-p}$ | 50 $\pm$ 10 V |             |   |
| Faceplate illuminance                    | $E$         | approx.       | 1 lx        |   |
| Faceplate temperature                    | $T$         |               | 20 to 45 °C |   |

**ELECTRON GUN CHARACTERISTICS**

Cut off

Grid 1 voltage for cut-off at  $V_{g2} = 300$  V,  
without blanking

$V_{g1}$       -35 to -100 V

Blanking voltage, peak to peak at  $V_{g2,4} = 300$  V,  
on grid 1

$V_{g1p-p}$       50  $\pm$  10 V

on cathode

$V_{kp-p}$       25 V

Grid 2 current at normally required  
beam currents

$I_{g2}$        $\leq$  0,5 mA



## PERFORMANCE

notes

|   |            |        |                                   |   |
|---|------------|--------|-----------------------------------|---|
| Dark current  | $I_d$      | $\leq$ | 3 nA                              |   |
| Sensitivity at colour temperature<br>of illuminance = 2856 K  | min.       | 130    | typ. 165 $\mu\text{A}/\text{lmF}$ | 5 |
| Sensitivity with P20 light source   | min.       | 395    | typ. 500 $\mu\text{A}/\text{lm}$  |   |
| Peak signal current with $E = 1 \text{ lx}$ (P20)   | min.       | 160    | typ. 200 nA                       | 6 |
| Gamma of transfer characteristic  |            |        | $0,95 \pm 0,05$                   |   |
| Spectral response,<br>max. at   | approx.    |        | 500 nm                            |   |
| cut-off at  | approx.    |        | 650 nm                            |   |
| Spectral response curve   | see Fig. 1 |        |                                   |   |
| Resolution  |            |        |                                   |   |
| Modulation depth, i.e. uncompensated<br>amplitude response at 13 lp/mm<br>(scanned area circle, diameter 15 mm)<br>at the centre of the picture.<br>(5 MHz, 400 TV lines)       |            |        | typ. 70 %                         | 7 |
| Modulation transfer characteristic  | see Fig. 2 |        |                                   |   |
| Decay lag, P20 light source, measured with<br>a signal current of 200 nA, beam adjusted<br>for correct stabilization after the target<br>has been illuminated for at least 5 s. |            |        |                                   |   |
| Residual signal after dark pulse<br>of 60 ms  | max.       | 6      | typ. 4 %                          |   |
| of 200 ms   | max.       | 2,5    | typ. 1,5 %                        |   |

**MECHANICAL DATA**

Mounting position: any

Net mass: approx. 60 g

Base: IEC 67-I-33a (JEDEC E8-11)

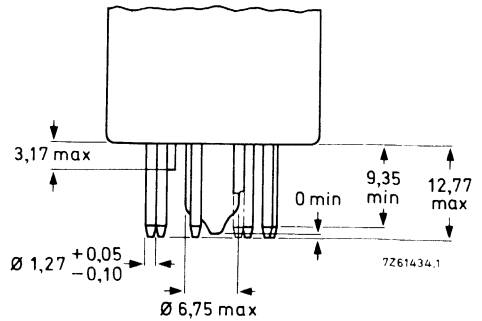
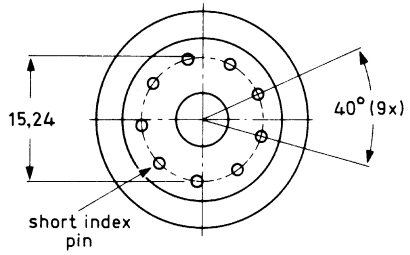
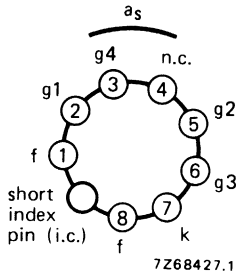
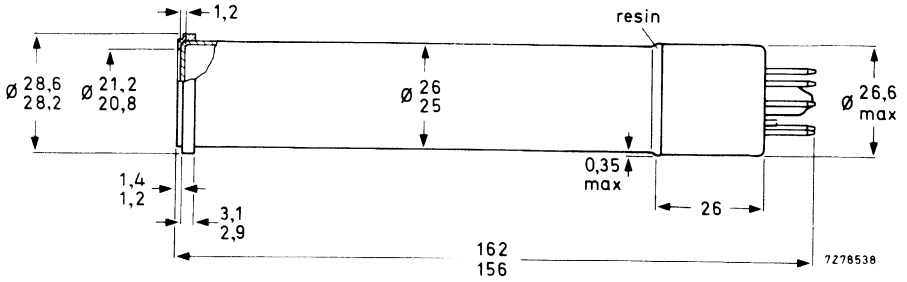

**NOTES**, see also General Section

1. The tube can withstand short excursions up to 70 °C without damage or irreversible degradation in performance.
2. For short intervals. During storage the tube face shall be covered with the plastic hood provided; when the camera is idle the lens shall be capped, in stand-by also the beam will be cut-off.
3. The operating conditions and performance data quoted relate to operation of the tube in coil unit AT1116S. See relevant data of deflection/focusing assemblies. Scanning amplitude should be adjusted such that the useful target area of 15 mm is displayed on a standard monitor as a circular area with a diameter equal to the raster height.
4. The beam current  $I_b$ , as obtained by adjusting the control grid (grid 1) voltage is set to max. 500 nA.  $I_b$  is not the actual current available in the scanning beam, but is defined as the maximum amount of signal,  $I_s$ , that can be obtained with this beam. See note 6.
5. Measuring conditions: illuminance level 4,54 lx at a colour temperature of 2856 K and a filter Schott VG9 inserted in the light path. For transmission of the filter, see General Section.
6. The peak signal currents are measured on a waveform oscilloscope and with a uniform illumination on the 15 mm diameter target area. When measured with an integrating instrument connected in the signal-electrode lead the average signal currents will be smaller:
  - a. by a factor  $\alpha = 100 - \beta/100$ ,  $\beta$  being the total blanking time in %; for the CCIR system  $\alpha$  amounts to 0,75.
  - b. by a factor  $\delta$ ,  $\delta$  being the ratio of the active target area (circle with 15 mm diameter) to the area which would correspond with the adjusted scanning amplitudes (15 x 20 mm). This ratio amounts to  $\delta = 0,59$ . The total ratio of integrated signal current,  $I_{sp}$ , to the peak signal current,  $I_{sp}$ , amounts to  $\alpha \times \delta = 0,44$ .
7. As measured with a 50 mm Leitz Summicron lens having a sine response of approximately 85% at 400 TV lines at  $f : 5,6$ . The published 70% typ. is uncorrected. Tube resolution is higher. Measured with 100 nA signal current and a beam current just sufficient to stabilize a signal current of 500 nA. The horizontal amplitude response can be raised by means of suitable correction circuits, which affect neither the vertical resolution nor the limiting resolution.

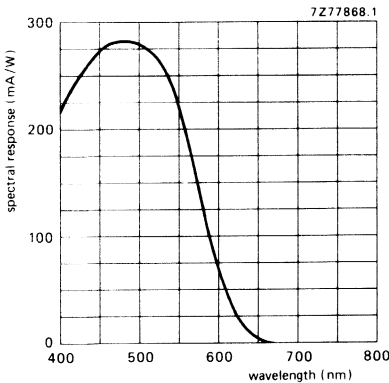

Fig. 1 Typical spectral response.

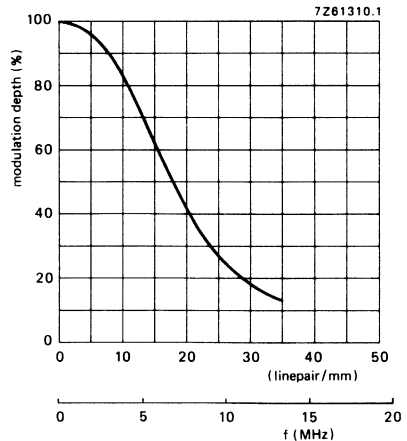

Fig. 2 Typical square-wave response curve.



## CAMERA TUBE

25,4 mm (1 inch) diameter Plumbicon® television camera tube, with high resolution lead-oxide photoconductive target. The XQ1073X is provided with a green BG18 anti halation glass disc for reduction of flare and is exclusively intended for use with X-ray image intensifiers with P20 output phosphor in medical equipment.

## QUICK REFERENCE DATA

|                                      |                                  |
|--------------------------------------|----------------------------------|
| Diameter                             | 25,4 mm (1 inch)                 |
| Length                               | approx. 162 mm                   |
| Focusing                             | magnetic                         |
| Deflection                           | magnetic                         |
| Useful target area, circle, diameter | 15 mm                            |
| Spectral response                    |                                  |
| max. at                              | approx. 500 nm                   |
| cut-off:                             | approx. 650 nm                   |
| Sensitivity, P20 light source        | typ. 485 $\mu\text{A}/\text{lm}$ |
| Resolution at 13 lp/mm (5 MHz)       | 75 %                             |
| Heater                               | 6,3 V, 95 mA                     |

## OPTICAL DATA

|   |                    |
|---|--------------------|
| Quality area on photoconductive target,<br>circle, diameter   | 15 mm              |
| Orientation of image on target:<br>For correct orientation of the image on the target the vertical scan should be essentially parallel to the plane passing through the tube axis and the marker line on the protecting sleeve at the base. |                    |
| Faceplate   |                    |
| Thickness   | 1,2 $\pm$ 0,1 mm   |
| Refractive index  | n = 1,49           |
| With anti-halation glass disc, BG18   |                    |
| Thickness   | 1,07 $\pm$ 0,05 mm |
| Refractive index  | n = 1,53           |

## ACCESSORIES

|                                   |              |
|-----------------------------------|--------------|
| Socket                            | type 56098   |
| Deflection and focusing coil unit | type AT1116S |

## ELECTRICAL DATA

|  |                      |
|--|----------------------|
| Deflection   | magnetic             |
| Focusing   | magnetic             |
| Heating, indirect by a.c. or d.c.:   |                      |
| Heater voltage   | $V_f$ 6,3 V $\pm$ 5% |
| Heater current at $V_f = 6,3$ V  | $I_f$ nom. 95 mA     |
| The heater voltage must not exceed an r.m.s. value of 9,5 V. For optimum performance stabilization of the heater voltage is recommended. |                      |
| Capacitance  |                      |
| Signal electrode to all  | $C_{as}$ 3 to 5 pF   |
| This capacitance, which is effectively the output impedance, increases when the tube is inserted in the coil unit.                       |                      |

® Registered trade mark for television camera tubes.

**LIMITING VALUES** (Absolute maximum rating system)

notes

Unless otherwise stated, all voltages are referred to the cathode.

|  |             |      |              |   |
|--|-------------|------|--------------|---|
| Signal electrode voltage                     | $V_{as}$    | max. | 50 V         |   |
| Grid 4 voltage                               | $V_{g4}$    | max. | 1100 V       |   |
| Grid 3 voltage                               | $V_{g3}$    | max. | 800 V        |   |
| Voltage between grid 4 and grid 3            | $V_{g4/g3}$ | max. | 450 V        |   |
| Grid 2 voltage                               | $V_{g2}$    | max. | 350 V        |   |
| Grid 2 dissipation                           | $W_{g2}$    | max. | 1 W          |   |
| Grid 1 voltage, positive                     | $V_{g1}$    | max. | 0 V          |   |
| Grid 1 voltage, negative                     | $-V_{g1}$   | max. | 125 V        |   |
| Cathode to heater voltage                    |             |      |              |   |
| positive peak                                | $V_{kfp}$   | max. | 125 V        |   |
| negative peak                                | $-V_{kfp}$  | max. | 50 V         |   |
| Cathode heating time before drawing          |             |      |              |   |
| cathode current                              | $t_h$       | min. | 1 min        |   |
| External resistance between cathode          |             |      |              |   |
| and heater at $-V_{kfp} > 10$ V              | $R_{kf}$    | min. | 2 k $\Omega$ |   |
| Ambient temperature, storage and operation   | $T_{amb}$   | max. | 50 °C        |   |
|  |             | min. | -30 °C       |   |
| Faceplate temperature, storage and operation | $T$         | max. | 50 °C        | 1 |
|  |             | min. | -30 °C       |   |
| Faceplate illuminance                        | $E$         | max. | 100 lx       | 2 |

**OPERATING CONDITIONS**

For a scanned circular area with a diameter of 15 mm

|  |             |               |             |   |
|--|-------------|---------------|-------------|---|
| Cathode voltage                          | $V_k$       | 0 V           |             | 3 |
| Signal electrode voltage                 | $V_{as}$    | 45 V          |             |   |
| Beam current                             | $I_b$       |               |             | 4 |
| Grid 4 voltage                           | $V_{g4}$    | 960 V         |             |   |
| Grid 3 voltage                           | $V_{g3}$    | 600 V         |             |   |
| Grid 2 voltage                           | $V_{g2}$    | 300 V         |             |   |
| Grid 1 voltage                           | $V_{g1}$    | V             |             | 4 |
| Blanking voltage on grid 1, peak to peak | $V_{g1p-p}$ | $50 \pm 10$ V |             |   |
| Faceplate illuminance                    | $E$         | approx.       | 1 lx        |   |
| Faceplate temperature                    | $T$         |               | 20 to 45 °C |   |

**ELECTRON GUN CHARACTERISTICS**

Cut off

|   |             |               |        |
|---|-------------|---------------|--------|
| Grid 1 voltage for cut-off at $V_{g2} = 300$ V,<br>without blanking | $V_{g1}$    | -35 to -100 V |        |
| Blanking voltage, peak to peak at $V_{g2,4} = 300$ V,<br>on grid 1  | $V_{g1p-p}$ | $50 \pm 10$ V |        |
| on cathode  | $V_{kp-p}$  | 25 V          |        |
| Grid 2 current at normally required<br>beam currents                | $I_{g2}$    | $\leq$        | 0,5 mA |

**PERFORMANCE**

notes

|   |            |        |                                   |   |
|---|------------|--------|-----------------------------------|---|
| Dark current  | $I_d$      | $\leq$ | 3 nA                              |   |
| Sensitivity at colour temperature<br>of illuminance = 2856 K  | min.       | 90     | typ. 115 $\mu\text{A}/\text{lmF}$ | 5 |
| Sensitivity with P20 light source   | min.       | 400    | typ. 485 $\mu\text{A}/\text{lm}$  |   |
| Peak signal current with $E = 1 \text{ lx}$ (P20)   | min.       | 160    | typ. 195 nA                       | 6 |
| Gamma of transfer characteristic  |            |        | $0,95 \pm 0,05$                   |   |
| Spectral response,<br>max. at   | approx.    |        | 500 nm                            |   |
| cut-off at  | approx.    |        | 650 nm                            |   |
| Spectral response curve   | see Fig. 1 |        |                                   |   |
| Resolution  |            |        |                                   | 7 |
| Modulation depth, i.e. uncompensated<br>amplitude response at 13 lp/mm<br>(scanned area circle, diameter 15 mm)<br>at the centre of the picture.<br>(5 MHz, 400 TV lines)       |            |        | typ. 75 %                         |   |
| Modulation transfer characteristic  | see Fig. 2 |        |                                   |   |
| Decay lag, P20 light source, measured with<br>a signal current of 200 nA, beam adjusted<br>for correct stabilization after the<br>target has been illuminated for at least 5 s. |            |        |                                   |   |
| Residual signal after dark pulse<br>of 60 ms  | max.       | 6      | typ. 4 %                          |   |
| of 200 ms   | max.       | 2,5    | typ. 1,5 %                        |   |

**MECHANICAL DATA**

Mounting position: any

Mass: approx. 60 g

Base: JEDEC E8-11, IEC 67-1-33a

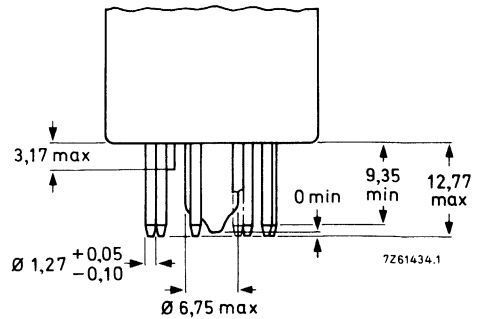
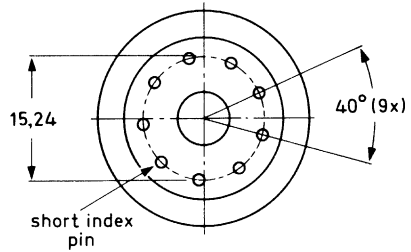
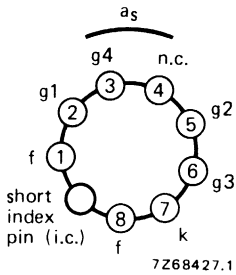
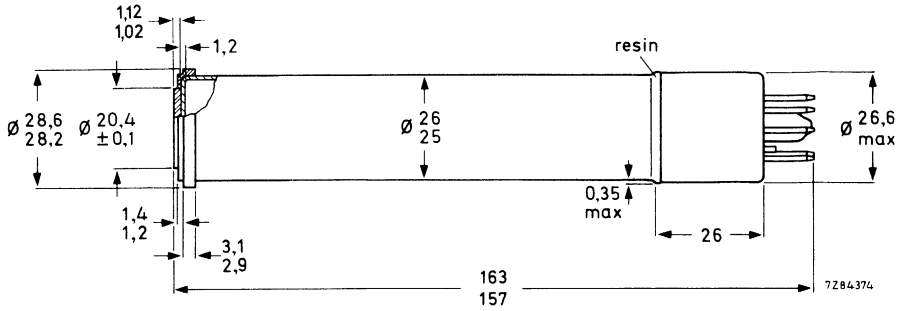



**NOTES**, see also General Section

1. The tube can withstand short excursions up to 70 °C without damage or irreversible degradation in performance.
2. For short intervals. During storage the tube face shall be covered with the plastic hood provided; when the camera is idle the lens shall be capped, in stand-by also the beam will be cut-off.
3. The operating conditions and performance data quoted relate to operation of the tube in coil unit AT1116S. See relevant data of deflection/focusing assemblies. Scanning amplitude should be adjusted such that the useful target area of 15 mm is displayed on a standard monitor as a circular area with a diameter equal to the raster height.
4. The beam current  $I_b$ , as obtained by adjusting the control grid (grid 1) voltage is set to max. 500 nA.  $I_b$  is not the actual current available in the scanning beam, but is defined as the maximum amount of signal,  $I_s$ , that can be obtained with this beam. See note 6.
5. Measuring conditions: illuminance level 4,54 lx at a colour temperature of 2856 K and a filter Schott VG9 inserted in the light path. For transmission of the filter, see General Section.
6. The peak signal currents are measured on a waveform oscilloscope and with a uniform illumination on the 18 mm diameter target area. When measured with an integrating instrument connected in the signal-electrode lead the average signal currents will be smaller:
  - a. by a factor  $\alpha$ , ( $\alpha = \{ 100 - \beta \} / 100$ ,  $\beta$  being the total blanking time in %; for the CCIR system  $\alpha$  amounts to 0,75.
  - b. by a factor  $\delta$ ,  $\delta$  being the ratio of the active target area (circle with 15 mm diameter) to the area which would correspond with the adjusted scanning amplitudes (15 x 20 mm). This ratio amounts to  $\delta = 0,59$ . The total ratio of integrated signal current,  $I_s$ , to the peak signal current,  $I_{sp}$ , amounts to  $\alpha \times \delta = 0,44$ .
7. As measured with a 50 mm Leitz Summicron lens having a sine response of approximately 85% at 400 TV lines at  $f : 5,6$ . The published 75% typ. is uncorrected. Tube resolution is higher. Measured with 100 nA signal current and a beam current just sufficient to stabilize a signal current of 500 nA. The horizontal amplitude response can be raised by means of suitable correction circuits, which affect neither the vertical resolution nor the limiting resolution.

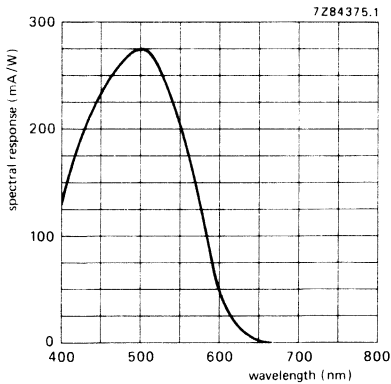

Fig. 1 Typical spectral response.

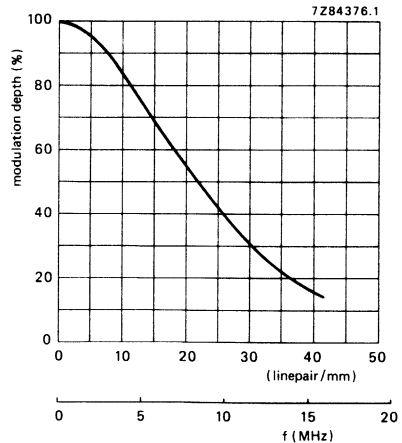

Fig. 2 Typical square-wave response curve.



## CAMERA TUBES

25,4 mm (1 inch) diameter Plumbicon® television camera tubes, with standard resolution lead-oxide photoconductive target, for use in high quality monochrome or colour cameras for broadcast, educational or industrial applications.

The XQ1080 series comprises the following versions:

|         |   |
|---------|---|
| XQ1080  | for use in monochrome cameras                                   |
| XQ1080L | for use in the luminance channel of colour cameras              |
| XQ1080R | for use in the red channel                                      |
| XQ1080G | for use in the green channel                                    |
| XQ1080B | for use in the blue channel                                     |
| XQ1083R | for use in the red channel; extended red response               |
| XQ1085R | for use in the red channel; extended red response and IR filter |

Special features are:

- Anti-Comet-Tail (ACT) electron gun for highlight handling
- Extremely low lag
- Provisions for light bias to reduce lag
- Target centring ring for precise optical alignment
- Low output capacitance for optimum signal-to-noise ratio
- Rear loading

### QUICK REFERENCE DATA

ACT electron gun

|  |         |                  |
|--|---------|------------------|
| Diameter                               |         | 25,4 mm (1 inch) |
| Length                                 | approx. | 165 mm           |
| Provided with anti-halation glass disc |         |                  |
| Focusing                               |         | magnetic         |
| Deflection                             |         | magnetic         |
| Useful target area (scanning area)     |         | 9,6 x 12,8 mm    |
| Spectral response                      |         |                  |
| max. at                                | approx. | 500 nm           |
| cut-off: XQ1080                        | approx. | 650 nm           |
| XQ1083                                 | approx. | 850 to 950 nm    |
| XQ1085                                 | approx. | 750 nm           |

Sensitivity

|                  |      |                              |
|------------------|------|------------------------------|
| XQ1080, XQ1080L  | typ. | 400 $\mu\text{A}/\text{lm}$  |
| XQ1080R          | typ. | 80 $\mu\text{A}/\text{lmF}$  |
| XQ1080G          | typ. | 155 $\mu\text{A}/\text{lmF}$ |
| XQ1080B          | typ. | 38 $\mu\text{A}/\text{lmF}$  |
| XQ1083R, XQ1085R | typ. | 100 $\mu\text{A}/\text{lmF}$ |

Resolution at 400 TV lines (5 MHz)

|                  |      |      |
|------------------|------|------|
| XQ1080, XQ1080L  | typ. | 40 % |
| XQ1080R          | typ. | 35 % |
| XQ1080G          | typ. | 40 % |
| XQ1080B          | typ. | 50 % |
| XQ1083R, XQ1085R | typ. | 45 % |

Heater

6,3 V, 95 mA

® Registered trademark for television camera tubes.

## OPTICAL DATA

notes

|  |               |
|--|---------------|
| Quality rectangle on photoconductive target (aspect ratio 3 : 4)   | 9,6 x 12,8 mm |
| Orientation of image on target:<br>For correct orientation of the image on the target the vertical scan should be essentially parallel to the plane passing through the tube axis and the marker line on the protecting sleeve at the base |               |
| Faceplate  |               |
| Thickness  | 1,2 ± 0,1 mm  |
| Refractive index   | n = 1,49      |
| Anti-halation glass disc provided with anti-reflective coating   |               |
| Thickness  | 5 ± 0,1 mm    |
| Refractive index   | n = 1,52      |
| XQ1085R is provided with an infrared reflecting filter   |               |

## ACCESSORIES

|                                    |                |
|------------------------------------|----------------|
| Socket                             | type 56026     |
| Deflection and focusing coil unit: |                |
| Black/white                        | type AT1119/01 |
| Colour                             | type AT1126T   |
| Mask for flare reduction           | type 56028     |
| Light bias lamp in holder          | type 56027     |

1

## ELECTRICAL DATA

|  |                        |
|--|------------------------|
| Deflection   | magnetic               |
| Focusing   | magnetic               |
| Heating, indirect by a.c. or d.c.; parallel supply   |                        |
| Heater voltage   | $V_f$ 6,3 V ± 5%       |
| Heater current at $V_f = 6,3$ V  | $I_f$ nom. 95 mA       |
| The heater voltage must not exceed an r.m.s. value of 9,5 V. For optimum performance lifetime and registration stability stabilization of the heater voltage is recommended. |                        |
| Capacitance  |                        |
| Signal electrode to all  | $C_{as}$ 2,5 to 3,5 pF |
| This capacitance, which is effectively the output impedance, increases when the tube is inserted in the coil unit.   |                        |

**LIMITING VALUES** (Absolute maximum rating system)

notes

Unless otherwise stated, all voltages are referred to the cathode.

|   |             |      |              |   |
|---|-------------|------|--------------|---|
| Signal electrode voltage  | $V_{as}$    | max. | 50 V         |   |
| Grid 6 (mesh) voltage   | $V_{g6}$    | max. | 1100 V       |   |
| Grid 5 (collector) voltage  | $V_{g5}$    | max. | 800 V        |   |
| Voltage between grid 6 and grid 5                                   | $V_{g6/g5}$ | max. | 350 V        |   |
| Grid 4 (limiter) and grid 2 (accelerator, first anode) voltage      | $V_{g2,4}$  | max. | 350 V        |   |
| Grid 3 (auxiliary) voltage  | $V_{g3}$    | max. | 350 V        |   |
| Grid 1 (control) voltage  |             |      |              |   |
| positive  | $V_{g1}$    | max. | 0 V          |   |
| negative  | $-V_{g1}$   | max. | 200 V        |   |
| Cathode heating time before drawing cathode current                 | $t_h$       | min. | 1 min        |   |
| Cathode to heater voltage   |             |      |              |   |
| positive peak   | $V_{kfp}$   | max. | 125 V        |   |
| negative peak   | $-V_{kfp}$  | max. | 50 V         |   |
| External resistance between cathode and heater at $-V_{kfp} > 10$ V | $R_{kf}$    | min. | 2 k $\Omega$ |   |
| Ambient temperature, storage and operation                          | $T_{amb}$   | max. | 50 °C        |   |
|   |             | min. | -30 °C       |   |
| Faceplate temperature, storage and operation                        | $T$         | max. | 50 °C        | 2 |
|   |             | min. | -30 °C       |   |
| Faceplate illuminance   | $E$         | max. | 500 lx       | 3 |

**OPERATING CONDITIONS** with ACT action

4, 5

For a scanned area of 9,6 x 12,8 mm. All voltages are specified with respect to the cathode potential during the read-out mode, unless otherwise indicated.

6, 7, 8

|   |            |  |           |    |
|---|------------|--|-----------|----|
| Cathode voltage   |            |  |           |    |
| during read-out mode  | $V_k$      |  | 0 V       |    |
| during ACT mode   | $V_k$      |  | 0 to 15 V |    |
| Signal electrode voltage  | $V_{as}$   |  | 45 V      |    |
| Grid 6 (mesh) voltage   | $V_{g6}$   |  | 750 V     | 9  |
| Grid 5 (collector) voltage  | $V_{g5}$   |  | 475 V     |    |
| Grid 4 (limiter) and grid 2 (accelerator, or first anode) voltage | $V_{g2,4}$ |  | 300 V     |    |
| Grid 3 (auxiliary) voltage  |            |  |           |    |
| during read-out mode  | $V_{g3}$   |  |           | 8  |
| during ACT mode   | $V_{g3}$   |  |           | 8  |
| Grid 1 (control) voltage  |            |  |           |    |
| during read-out mode  | $V_{g1}$   |  |           | 10 |
| during ACT mode   | $V_{g1}$   |  |           | 8  |
| Blanking voltage on grid 1, peak                                  | $V_{g1p}$  |  | 50 V      |    |

Typical beam current, signal current  
and pulse settings

notes  
8,10

|                      |           | XQ1080<br>XQ1080L | XQ1080R<br>XQ1083R<br>XQ1085R | XQ1080G | XQ1080B |         |
|----------------------|-----------|-------------------|-------------------------------|---------|---------|---------|
| Signal current, peak | $I_{sp}$  | 0,2               | 0,1                           | 0,2     | 0,1     | $\mu A$ |
| Beam current, peak   | $I_{bp}$  | 0,4               | 0,2                           | 0,4     | 0,2     | $\mu A$ |
| ACT level, peak      |           | 0,28              | 0,14                          | 0,28    | 0,14    | $\mu A$ |
| Cathode pulse        | $V_{kp}$  | 8                 | 4                             | 8       | 4       | V       |
| Grid 1 pulse         | $V_{g1p}$ | 28                | 24                            | 28      | 24      | V       |
| Grid 3 pulse         | $V_{g3p}$ |                   | see note 8                    |         |         |         |

|                       |  |             |    |
|-----------------------|--|-------------|----|
| Faceplate illuminance |  | 0 to 10 lx  | 11 |
| Faceplate temperature |  | 20 to 45 °C | 2  |

## ELECTRON GUN CHARACTERISTICS

Cut off

|  |              |               |    |
|--|--------------|---------------|----|
| Grid 1 voltage for cut-off at $V_{g2,4} = 300 V$ ,<br>without blanking or ACT pulses | $V_{g1}$     | -40 to -110 V |    |
| Blanking voltage, peak to peak at $V_{g2,4} = 300 V$<br>on grid 1                    | $V_{g1p-p}$  | $50 \pm 10 V$ | 12 |
| Grids 2 and 4 current (d.c. values)  | $I_{g2,4}$   | < 0,2 mA      | 13 |
| Grids 3, 5 and 6 current   | $I_{g3,5,6}$ |               | 13 |
| Pulse timing and amplitude requirements (ACT)  |              |               | 8  |

## PERFORMANCE

|   |                     |                      |    |
|---|---------------------|----------------------|----|
| Dark current, without light bias                          | $I_d$               | $\leq 1 nA$          |    |
| Sensitivity at colour temperature of illuminance = 2856 K |                     |                      | 14 |
| XQ1080, XQ1080L   | min. 330            | typ. 400 $\mu A/lm$  |    |
| XQ1080R   | min. 70             | typ. 80 $\mu A/lmF$  |    |
| XQ1080G   | min. 130            | typ. 155 $\mu A/lmF$ |    |
| XQ1080B   | min. 35             | typ. 38 $\mu A/lmF$  |    |
| XQ1083R, XQ1085R  | min. 75             | typ. 100 $\mu A/lmF$ |    |
| Gamma of transfer characteristics                         |                     | $0,95 \pm 0,05$      |    |
| Light transfer characteristics with ACT                   | see Fig. 2          |                      |    |
| Highlight handling  | $\geq 5$ lens stops |                      | 15 |
| Spectral response, max. at                                | approx.             | 500 nm               |    |
| Spectral response, cut off:                               |                     |                      |    |
| XQ1080  | approx.             | 650 nm               |    |
| XQ1083  | approx.             | 850 to 950 nm        |    |
| XQ1085  | approx.             | 750 nm               |    |
| Spectral response curves                                  | see Figs 3, 4 and 5 |                      |    |

notes  
16

## Resolution

Modulation depth, i.e. uncompensated amplitude response at 400 TV lines at the centre of the picture. The figures shown represent the horizontal amplitude response as measured with a lens aperture  $f : 5,6$ .

## Modulation transfer characteristics

see Figs 6 and 6a

|                                  | XQ1080<br>XQ1080L | XQ1080R | XQ1080G | XQ1080B | XQ1083R<br>XQ1085R |    |
|----------------------------------|-------------------|---------|---------|---------|--------------------|----|
| Highlight signal current $I_s$   | 200               | 100     | 200     | 100     | 100                | nA |
| Beam current $I_b$               | 400               | 200     | 400     | 200     | 200                | nA |
| Modulation depth at 400 TV lines |                   |         |         |         |                    |    |
| typ.                             | 40                | 35      | 40      | 50      | 45                 | %  |
| min.                             | 35                | 30      | 35      | 45      | 35                 | %  |

## Lag (typical values)

17

Light source with a colour temperature of 2856 K. Appropriate filter inserted in the light path for the chrominance tubes R, G and B.

## LOW KEY CONDITIONS (with light bias of 3 nA)

|                          | build-up lag                  |                 | decay lag                     |        |
|--------------------------|-------------------------------|-----------------|-------------------------------|--------|
|                          | $I_s/I_b = 20/300 \text{ nA}$ |                 | $I_s/I_b = 20/300 \text{ nA}$ |        |
|                          | 60 ms                         | 200 ms          | 60 ms                         | 200 ms |
| XQ1080, XQ1080L, XQ1080G | 98%                           | $\approx 100\%$ | 6%                            | 1,5%   |
| XQ1080R                  | 95%                           | $\approx 100\%$ | 6%                            | 2,5%   |
| XQ1080B                  | 95%                           | $\approx 100\%$ | 8,5%                          | 3,5%   |
| XQ1083R                  | 95%                           | $\approx 100\%$ | 8%                            | 3%     |
| XQ1085R                  | 95%                           | $\approx 100\%$ | 8%                            | 3%     |

Typical effect of light bias on built-up and decay lag under low key signal current and beam settings are shown in Figs 7 to 14.

Shading of light bias induced dark current

12,5%

18

19

MECHANICAL DATA

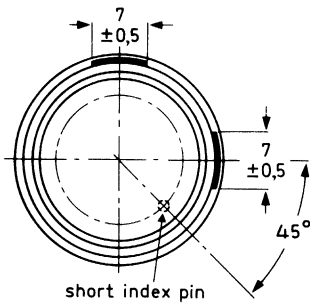
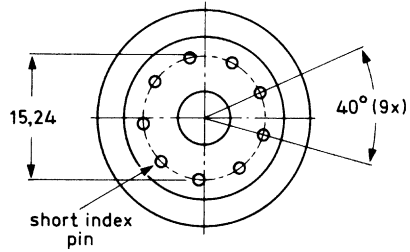
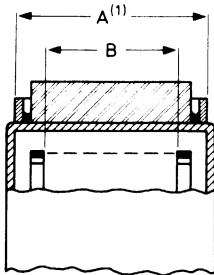
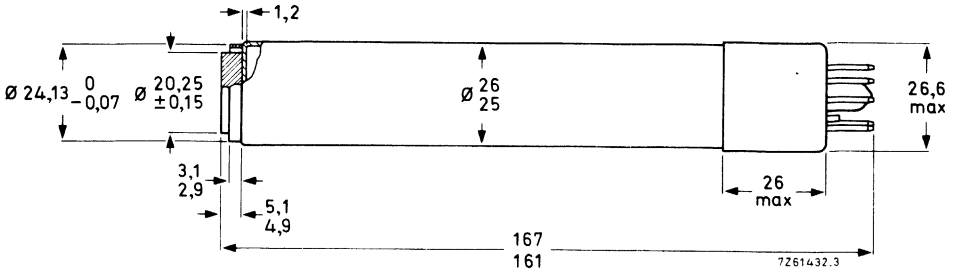

FRONT VIEW

7261433.3

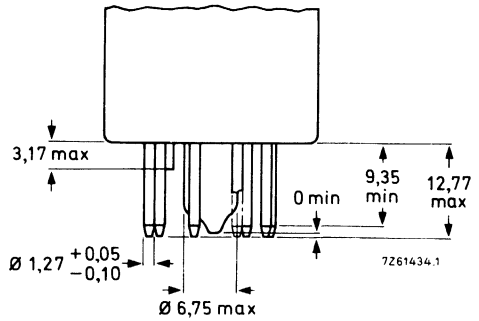

Mounting position: any

Mass:  $\approx 70$  g

Base: IEC 67-1-33a (JEDEC E8-11)

(1) The distance between the geometrical centres of the diameter A of the reference ring and the diameter B of the mesh-electrode ring is  $< 100 \mu\text{m}</math>.$

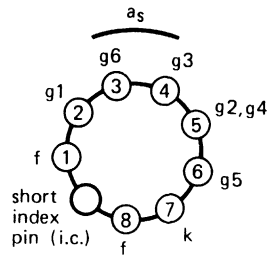

7261431.1



**NOTES**, see also General Section.

1. The light bias lamp in its holder fits into the socket type 56026 and requires maximum 5 V, 110 mA. Its light is projected on to the pumping stem via a blue-green transmitting filter and is conducted to cause a bias illuminance on the target. The required amount of light bias can be obtained by adjusting the filament current of the lamp.
2. The tube can withstand short excursions up to 70 °C without damage or irreversible degradation in performance.
3. For short intervals. During storage the tube face shall be covered with the plastic hood provided; when the camera is idle the lens shall be capped, in stand-by also the beams will be cut-off.
4. The operating conditions and performance data quoted relate to operation of the tube in coil units AT1126 and AT1119. See relevant data of deflection/focusing assemblies.
5. When the tube is to be used without ACT action, grid 3 should be connected to grids 2 and 4 and no ACT pulses should be applied to the cathode and grid 1. The performance of the tube will then be as described herein with the exception of the highlight handling.
6.
  - a. For proper ACT action the d.c. voltage supply and/or pulse supply to the various electrodes should have sufficiently low impedance; see note 13.
  - b. Video preamplifier: In the presence of highlights, peak signal currents of the order of 15 to 45  $\mu\text{A}$  may be offered to the preamplifier during flyback. Special measures have to be taken in the preamplifier to prevent temporary overloading.
7.
  - a. Read-out mode: Defined as the operating conditions during the active line scan (full line period-line blanking interval). For the CCIR system this will amount to 64  $\mu\text{s}$  – 12  $\mu\text{s}$  = 52  $\mu\text{s}$ .
  - b. ACT mode: Defined as the operating conditions during that part of the line blanking interval during which the ACT electrode gun is fully operative. The ACT interval is equal to or slightly within the line flyback time.
8. Pulse timing (CCIR) and amplitudes for ACT action: (blanking applied to grid 1, see note 12)
  - a. For proper operation and setting up of the ACT electron gun three electrodes have to be pulsed:
    - Cathode: A positive-going pulse,  $V_{kp}$ , with an adjustable amplitude of 0 to 20 V. This pulse can be chosen to coincide with the camera blanking period (approx. 11  $\mu\text{s}$ ). The amplitude of this pulse determines the ACT cutting level and may in general be preset to 8, 4, 8 and 4 V, for black/white, R, G, and B application respectively. An amplitude of 20 V should be available to preset the  $I_s/I_b$ ; see note 10.
    - Grid 1: A positive-going pulse,  $V_{g1p}$ , with such an amplitude that during the ACT mode the grid 1 bias is effectively reduced by 20 V, ( $V_{g1p} = 20 \text{ V} + V_{kp}$ ), to produce an extra amount of cathode current. The duration of this pulse should be so chosen that it is just within the flyback period (approx. 5  $\mu\text{s}$ ).
    - Grid 3: A negative-going pulse,  $V_{g3p}$ , timing and duration coinciding with  $V_{g1p}$ , with:
      - either an adjustable amplitude and superimposed on a fixed grid 3 voltage of 250 to 300 V,
      - or with fixed amplitude and superimposed on an adjustable grid 3 voltage of 250 to 300 V, in either case, adjusted to result in a grid 3 voltage of 8,5 V with respect to the cathode voltage during the ACT mode. This pulse ensures that an adequate amount of beam current is drawn from the cathode current.
  - b. A suggested pulse timing and amplitude diagram is shown in Fig. 1.
9. Operation with ACT at  $V_{g6} > 750 \text{ V}$  is not recommended since this may introduce dark current.

10. Adjusted with the ACT made inoperative, e.g. by setting the cathode pulse to 20 V. The control grid voltage is adjusted to produce a beam current just sufficient to allow a peak signal current of twice the typical value,  $I_{sp}$ , as observed and measured on a waveform oscilloscope. This amount of beam current is termed  $I_{bp}$ .  $I_b$  is set at 200 nA for R and B tubes and at 400 nA for L and G tubes. N.B. The signal current,  $I_s$ , and the beam current,  $I_b$ , conditions quoted with the performance figures for e.g. lag relate to measurements with an integrating instrument connected in the signal electrode lead and a uniform illuminance on the scanned area. The corresponding peak currents  $I_{sp}$  and  $I_{bp}$ , as measured on a waveform oscilloscope will be a factor  $\alpha$  larger.

$$\alpha = \frac{100}{100 - \beta} ;$$

$\beta$  being the total blanking time in %; for CCIR system  $\alpha = 1,3$ .

11. Typical faceplate illumination level for the XQ1080 and XQ1080L to produce 200 nA signal current will be approx. 4 lx. The signal currents stated for the colour tubes R, G and B will be obtained with an incident white light level (2856 K) on the filter of approx. 8,5 lx. These figures are based on the filters described in note 14. For filter BG12, however, a thickness of 1 mm is chosen.
12. Blanking can also be applied to the cathode:
- without ACT action; required cathode pulse approx. 25 V
  - with ACT action; timing, polarity and amplitudes of the ACT pulses will have to be adapted.
13. The d.c. voltage supply and/or pulse supply to these electrodes should have a sufficiently low impedance to prevent distortion caused by the peak currents drawn during the ACT mode. These peak currents may amount to:

|               |             |
|---------------|-------------|
| cathode       | 2 mA        |
| grid 1        | 0 mA        |
| grids 2 and 4 | 1 mA        |
| grid 3        | 150 $\mu$ A |
| grid 5        | 300 $\mu$ A |
| grid 6        | 300 $\mu$ A |

The cathode impedance should be preferably be chosen  $\leq 300 \Omega$ .

14. Measuring conditions: illuminance level 4,54 lx at a colour temperature of 2856 K and the appropriate filter inserted in the light path. The signal current obtained in nA is a measure of the colour sensitivity expressed in  $\mu$ A per lumen of white light before the filter. Filters used are:

|                  |             |       |           |      |
|------------------|-------------|-------|-----------|------|
| XQ1080R, XQ1085R | Schott      | OG570 | thickness | 3 mm |
| XQ1080G          | Schott      | VG9   | thickness | 1 mm |
| XQ1080B          | Schott      | BG12  | thickness | 3 mm |
| XQ1083R          | Schott      | OG570 | thickness | 3 mm |
|                  | and Calflex | B1/K1 |           |      |

For transmission curves see General Section.

15. With pulses applied as indicated in note 8 the tube will properly handle a highlight with a diameter of 10% of picture height and with a luminance corresponding to 32 times peak signal white,  $I_{sp}$ .
16. As measured with a 50 mm Leitz Summicron lens having a sine response of approximately 85% at 400 TV lines at  $f : 5,6$  and the appropriate filter inserted in the light path. The horizontal amplitude response can be raised by means of suitable correction circuits, which affect neither the vertical resolution nor the limiting resolution.
17. **Build-up lag**

After 10 s of darkness. The figures are typical percentages of the ultimate signal current obtained 60 ms and 200 ms, respectively, after the introduction of the illuminance.

**Decay lag**

After the target has been illuminated for at least 5 s. The figures represent typical signals in percentages of the original signal current 60 ms and 200 ms, respectively, after removal of the illuminance.

18. A reduction of lag, especially under low key conditions is obtained when light bias is applied. Infrared light with a wavelength  $> 600$  nm in the light bias should be avoided.
- For monochrome operation a light bias corresponding to 2 to 3 nA dark current is usually adequate for excellent speed of response.
  - Adjustable light bias (colour camera).  
In a colour camera the speeds of response of the tubes can be balanced by adjusting the amount of light bias per tube.  
In a 3-tube colour camera for instance it is recommended to first adjust the tubes to their normal highlight signal current and beam current settings and then point the camera at a dark scene comprising a metronome. The moving hand of the metronome carries a small white square. The illuminance should be chosen such that the square produces a peak signal of approximately 50 nA in the green chrominance channel. A maximum of 3 nA artificial dark current shall then be introduced in green chrominance tube. Subsequently light bias shall be applied to the tubes in the red and blue channels until the lag of the three tubes is neutralized.  
A typical setting for correct speeds of response in a 3-tube colour camera would be approximately 3 nA(p) (R), 2 nA(p) (G) and 3,5 nA(p) (B).
19. Deviation of the level of any of the four corners, i.e. 10% inwards in H and V direction from the level in the picture centre. With the settings suggested in note 18 black shading compensation in the camera video processing amplifier will not normally be required. Further improvement in lag can be obtained by applying still higher light bias levels. It may then be necessary to use black shading compensation in the video processing amplifier.

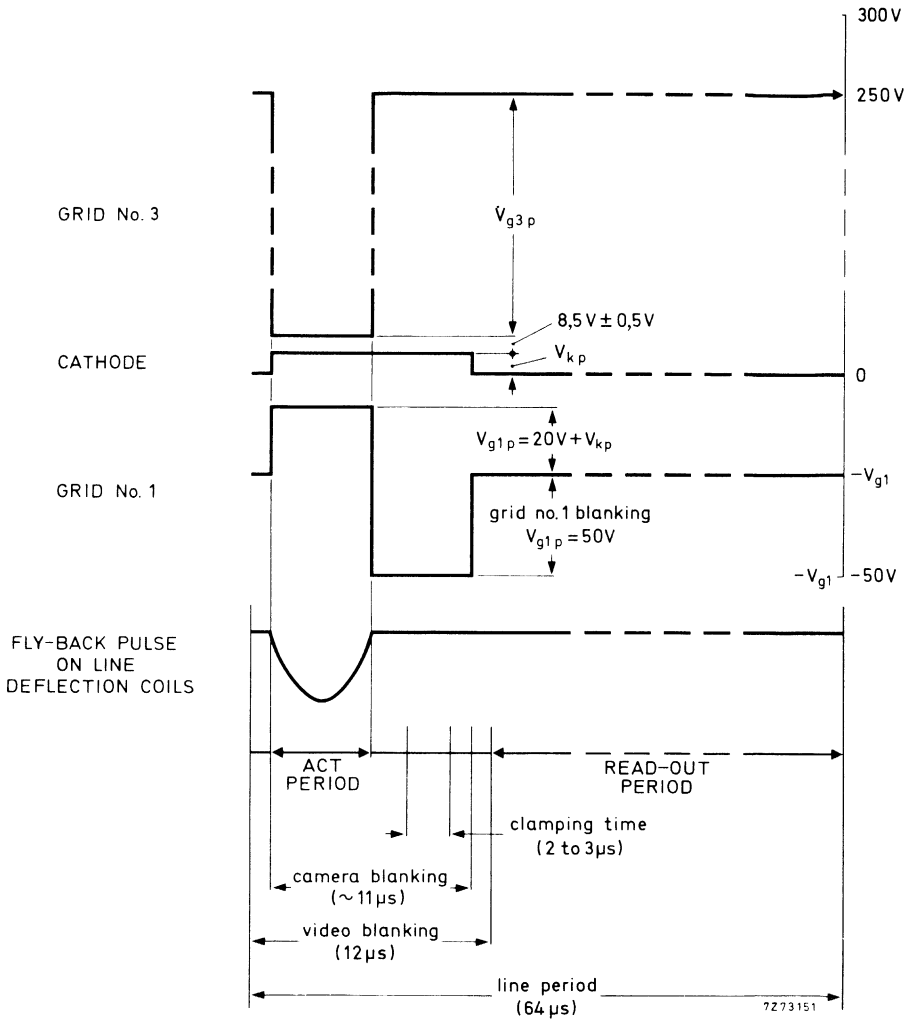

Fig. 1 Pulse timing and amplitude diagram.

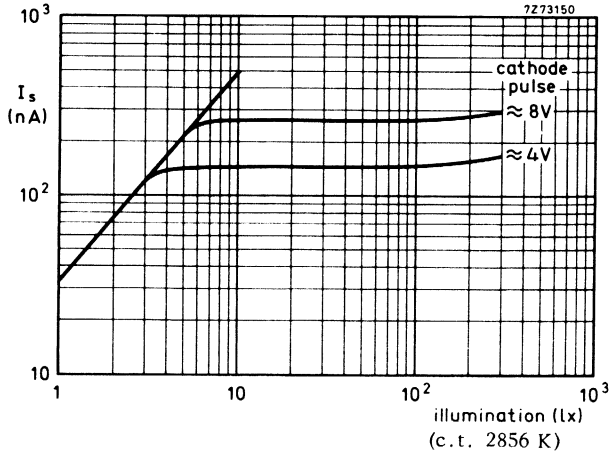

Fig. 2 Typical light transfer characteristics with ACT applied.

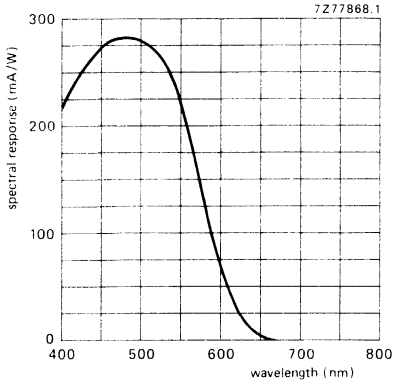

Fig. 3 Typical spectral response for XQ1080.

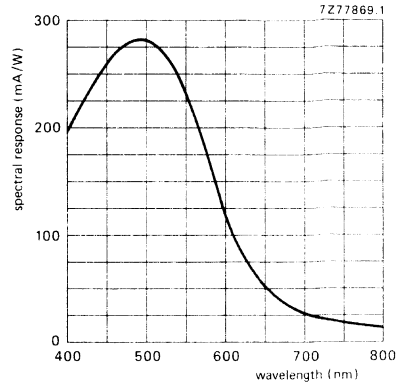

Fig. 4 Typical spectral response for XQ1083R.

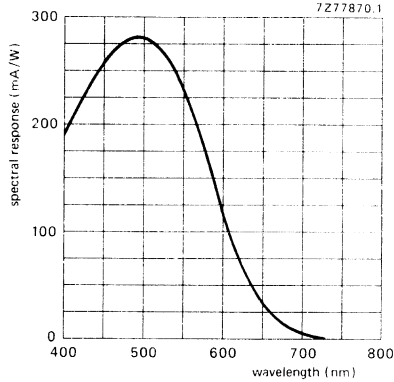

Fig. 5 Typical spectral response for XQ1085R.

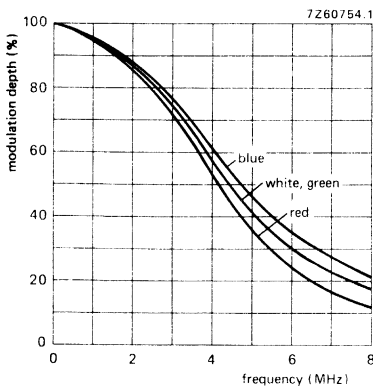

Fig. 6 Typical square-wave response curves for XQ1080.

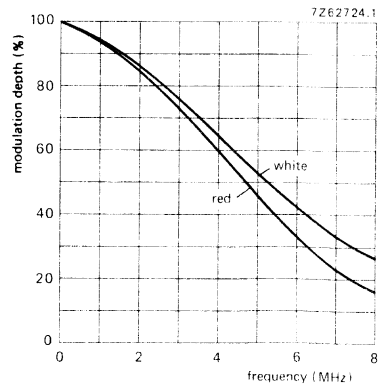

Fig. 6a Typical square-wave response curves for XQ1083, XQ1085.

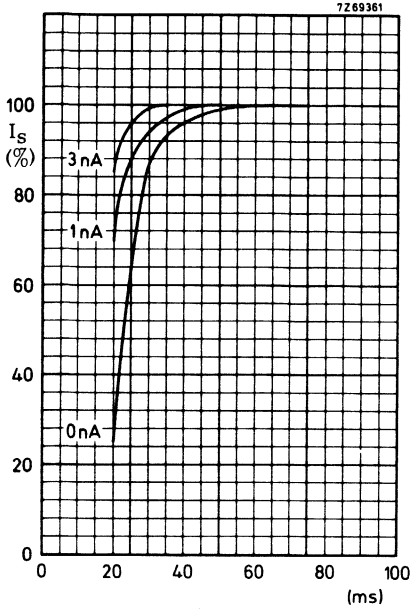

Fig. 7.

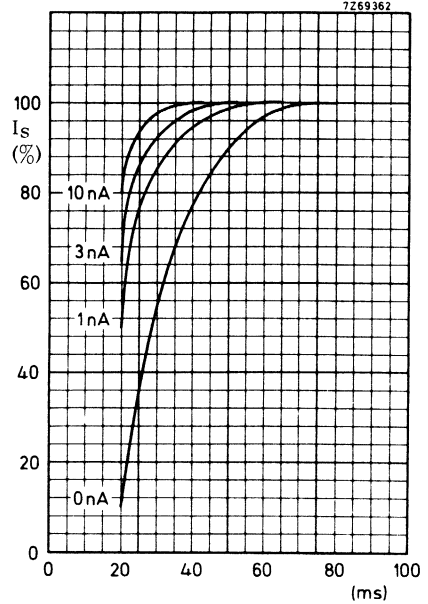

Fig. 8.

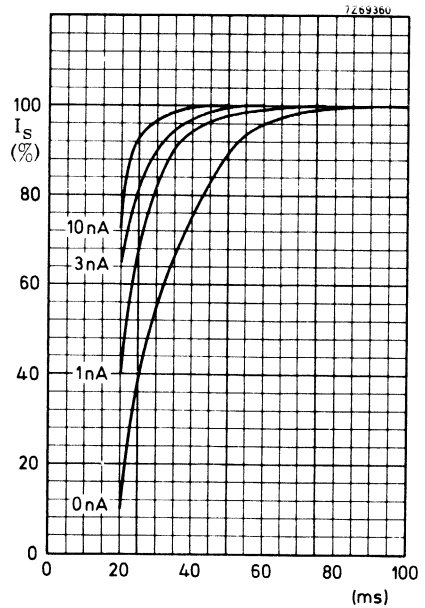

Fig. 9.

**Build-up lag (see note 17)**

Light bias induced dark current as parameter.

Fig. 7 XQ1080, XQ1080L, XQ1080G.  
 $I_s/I_B = 40/400$  nA.

Fig. 8 XQ1080R.  $I_s/I_B = 20/200$  nA.

Fig. 9 XQ1080B.  $I_s/I_B = 20/200$  nA.

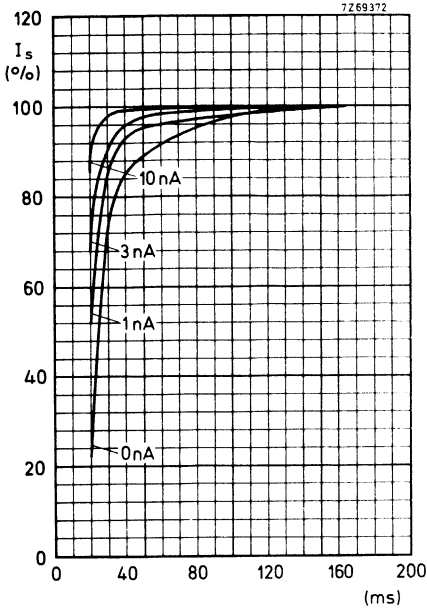

Fig. 10.

**Build-up lag** (See note 17)

Light bias induced dark current as parameter.  
 XQ1083R, XQ1085R;  
 $I_s/I_b = 20/200$  nA.

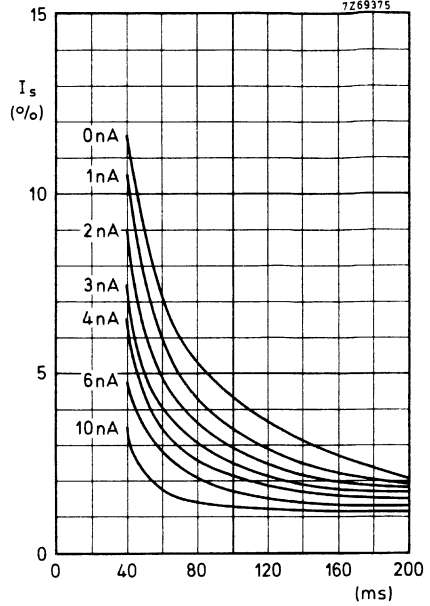

Fig. 11.

**Decay lag** (See note 17)

Light bias induced dark current as parameter.  
 XQ1083R, XQ1085R;  
 $I_s/I_b = 20/200$  nA.



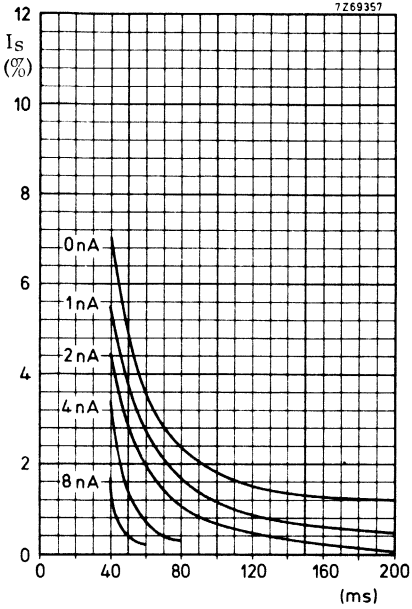

Fig. 12.

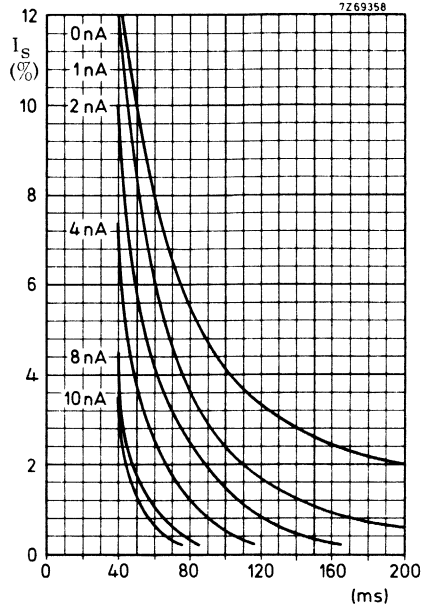

Fig. 13.

**Decay lag** (see note 17)

Light bias induced dark current as parameter.

Fig. 12 XQ1080, XQ1080L, XQ1080G.  $I_S/I_b = 40/400$  nA.

Fig. 13 XQ1080R.  $I_S/I_b = 20/200$  nA.

Fig. 14 XQ1080B.  $I_S/I_b = 20/200$  nA.

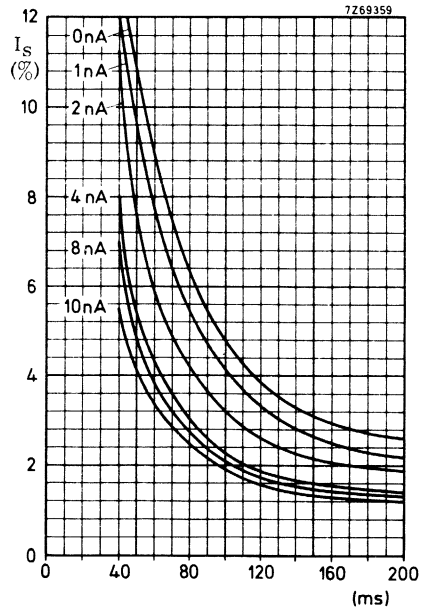

Fig. 14.



## CAMERA TUBES

25,4 mm (1 inch) diameter Plumbicon® television camera tubes, with standard resolution lead-oxide photoconductive target, for use in high quality monochrome or colour cameras for broadcast, educational or industrial applications.

The XQ1090 series comprises the following versions:

|         |   |
|---------|---|
| XQ1090  | for use in monochrome cameras                                   |
| XQ1090L | for use in the luminance channel of colour cameras              |
| XQ1090R | for use in the red channel                                      |
| XQ1090G | for use in the green channel                                    |
| XQ1090B | for use in the blue channel                                     |
| XQ1093R | for use in the red channel; extended red response               |
| XQ1095R | for use in the red channel; extended red response and IR filter |

The tubes of the XQ1090 series are provided with an ACT electron gun and provisions for light bias like the tubes of the XQ1080 series but are front loading types.

The electrical and mechanical data of the tubes are identical to those of the XQ1080 series with the following exceptions.

## ELECTRICAL DATA

**Capacitance**

|                         |          |           |
|-------------------------|----------|-----------|
| Signal electrode to all | $C_{as}$ | 3 to 5 pF |
|-------------------------|----------|-----------|

## ACCESSORIES

|                                   |           |
|-----------------------------------|-----------|
| Deflection and focusing coil unit | AT1116/06 |
|-----------------------------------|-----------|

® Registered trade mark for camera tubes.

MECHANICAL DATA

Dimensions in mm

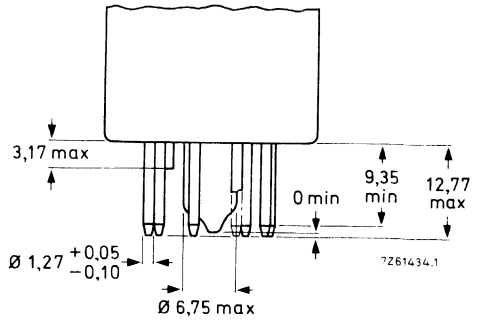
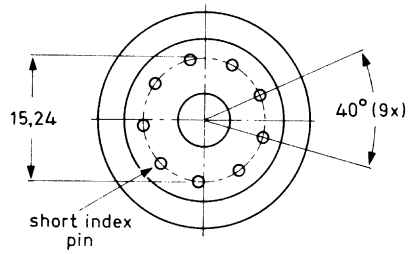
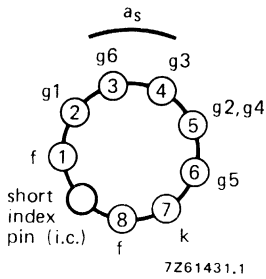
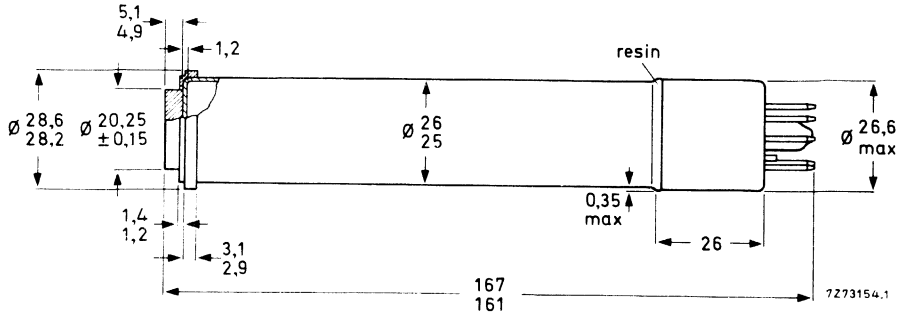

## CAMERA TUBES

25,4 mm (1 inch) diameter Plumbicon® television camera tubes, with high resolution lead-oxide photoconductive target, for use in high quality monochrome or colour cameras for broadcast, educational or industrial applications.

The XQ1500 series comprises the following versions:

- XQ1500 for use in monochrome cameras
- XQ1500L for use in the luminance channel of colour cameras
- XQ1500R for use in the red channel
- XQ1500G for use in the green channel
- XQ1500B for use in the blue channel
- XQ1503R for use in the red channel; extended red response
- XQ1505R for use in the red channel; extended red response and IR filter

Special features are:

- Anti-Comet-Tail (ACT) electron gun for highlight handling
- Extremely low lag
- Provisions for light bias to reduce lag
- Target centring ring for precise optical alignment
- Low output capacitance for optimum S/N ratio
- Increased resolving power as compared with XQ1080 series
- Rear loading

### QUICK REFERENCE DATA

|  |                       |
|--|-----------------------|
| ACT electron gun                       |                       |
| Diameter                               | 25,4 mm (1 inch)      |
| Length                                 | approx. 165 mm        |
| Provided with anti-halation glass disc |                       |
| Focusing                               | magnetic              |
| Deflection                             | magnetic              |
| Useful target area (scanning area)     | 9,6 x 12,8 mm         |
| Spectral response                      |                       |
| max. at                                | approx. 500 nm        |
| cut-off: XQ1500                        | approx. 650 nm        |
| XQ1503                                 | approx. 850 to 950 nm |
| XQ1505                                 | approx. 750 nm        |
| Sensitivity                            |                       |
| XQ1500, XQ1500L                        | typ. 375 $\mu$ A/lm   |
| XQ1500R                                | typ. 80 $\mu$ A/lmF   |
| XQ1500G                                | typ. 155 $\mu$ A/lmF  |
| XQ1500B                                | typ. 38 $\mu$ A/lmF   |
| XQ1503R, XQ1505R                       | typ. 100 $\mu$ A/lmF  |
| Resolution at 400 TV lines (5 MHz)     |                       |
| XQ1500, XQ1500L                        | typ. 50 %             |
| XQ1500R                                | typ. 40 %             |
| XQ1500G                                | typ. 50 %             |
| XQ1500B                                | typ. 55 %             |
| XQ1503R, XQ1505R                       | typ. 50 %             |
| Heater                                 | 6,3 V, 190 mA         |

® Registered trade mark for television camera tubes.

## OPTICAL DATA

notes

|   |               |
|---|---------------|
| Quality rectangle on photoconductive target (aspect ratio 3 : 4)  | 9,6 x 12,8 mm |
| Orientation of image on target:   |               |
| For correct orientation of the image on the target the vertical scan should be essentially parallel to the plane passing through the tube axis and the marker line on the protecting sleeve at the base |               |
| Faceplate   |               |
| Thickness   | 1,2 ± 0,1 mm  |
| Refractive index  | n = 1,49      |
| Anti-halation glass disc provided with anti-reflective coating  |               |
| Thickness   | 5 ± 0,1 mm    |
| Refractive index  | n = 1,52      |
| XQ1505R is provided with an infrared reflecting filter.   |               |

## ACCESSORIES

|                                    |                |   |
|------------------------------------|----------------|---|
| Socket                             | type 56026     |   |
| Deflection and focusing coil unit: |                |   |
| Black/white                        | type AT1119/01 |   |
| Colour                             | type AT1126T   |   |
| Mask for flare reduction           | type 56028     |   |
| Light bias lamp in holder          | type 56027     | 1 |

## ELECTRICAL DATA

|  |            |               |
|--|------------|---------------|
| Deflection   |            | magnetic      |
| Focusing   |            | magnetic      |
| Heating, indirect by a.c. or d.c.; parallel supply   |            |               |
| Heater voltage   | $V_f$      | 6,3 V ± 5%    |
| Heater current at $V_f = 6,3$ V  | $I_f$ nom. | 190 mA        |
| The heater voltage must not exceed an r.m.s. value of 9,5 V. For optimum performance (lifetime and registration stability) stabilization of the heater voltage is recommended. |            |               |
| Capacitance  |            |               |
| Signal electrode to all  | $C_{as}$   | 2,5 to 3,5 pF |
| This capacitance, which is effectively the output impedance, increases when the tube is inserted in the coil unit.   |            |               |

**LIMITING VALUES** (Absolute maximum rating system)

notes

Unless otherwise stated, all voltages are referred to the cathode.

|  |             |      |              |   |
|--|-------------|------|--------------|---|
| Signal electrode voltage   | $V_{as}$    | max. | 50 V         |   |
| Grid 6 (mesh) voltage  | $V_{g6}$    | max. | 1100 V       |   |
| Grid 5 (collector) voltage   | $V_{g5}$    | max. | 800 V        |   |
| Voltage between grid 6 and grid 5                                      | $V_{g6/g5}$ | max. | 350 V        |   |
| Grid 4 (limiter) and grid 2 (accelerator,<br>first anode) voltage      | $V_{g2,4}$  | max. | 350 V        |   |
| Grid 3 (auxiliary) voltage   | $V_{g3}$    | max. | 350 V        |   |
| Grid 1 (control) voltage,<br>positive                                  | $V_{g1}$    | max. | 0 V          |   |
| negative   | $-V_{g1}$   | max. | 200 V        |   |
| Cathode heating time before drawing<br>cathode current                 | $t_h$       | min. | 1 min        |   |
| Cathode to heater voltage<br>positive peak                             | $V_{kfp}$   | max. | 50 V         |   |
| negative peak  | $-V_{kfp}$  | max. | 50 V         |   |
| External resistance between cathode<br>and heater at $-V_{kfp} > 10$ V | $R_{kf}$    | min. | 2 k $\Omega$ |   |
| Ambient temperature, storage and operation                             | $T_{amb}$   | max. | 50 °C        |   |
|  |             | min. | -30 °C       |   |
| Faceplate temperature, storage and operation                           | $T$         | max. | 50 °C        | 2 |
|  |             | min. | -30 °C       |   |
| Faceplate illuminance  | $E$         | max. | 500 lx       | 3 |

**OPERATING CONDITIONS** (with ACT action)

4,5

For a scanned area of 9,6 x 12,8 mm. All voltages are specified with respect to the cathode potential during the read-out mode, unless otherwise indicated.

6,7,8

|  |            |           |    |
|--|------------|-----------|----|
| Cathode voltage<br>during read-out mode                              | $V_k$      | 0 V       |    |
| during ACT mode  | $V_k$      | 0 to 15 V |    |
| Signal electrode voltage   | $V_{as}$   | 45 V      |    |
| Grid 6 (mesh) voltage  | $V_{g6}$   | 750 V     | 9  |
| Grid 5 (collector) voltage   | $V_{g5}$   | 475 V     |    |
| Grid 4 (limiter) and grid 2 (accelerator,<br>or first anode) voltage | $V_{g2,4}$ | 300 V     |    |
| Grid 3 (auxiliary) voltage<br>during read-out mode                   | $V_{g3}$   |           | 8  |
| during ACT mode  | $V_{g3}$   |           | 8  |
| Grid 1 (control) voltage<br>during read-out mode                     | $V_{g1}$   |           | 10 |
| during ACT mode  | $V_{g1}$   |           | 8  |
| Blanking voltage on grid 1, peak                                     | $V_{g1p}$  | 50 V      |    |

Typical beam current, signal current  
and pulse settings:

8,10

|                               | XQ1500<br>XQ1500L | XQ1500R<br>XQ1503R<br>XQ1505R | XQ1500G | XQ1500B |            |
|-------------------------------|-------------------|-------------------------------|---------|---------|------------|
| Signal current, peak $I_{sp}$ | 0,2               | 0,1                           | 0,2     | 0,1     | $\mu A$    |
| Beam current, peak $I_{bp}$   | 0,4               | 0,2                           | 0,4     | 0,2     | $\mu A$    |
| ACT level, peak               | 0,28              | 0,14                          | 0,28    | 0,14    | $\mu A$    |
| Cathode pulse $V_{kp}$        | 8                 | 4                             | 8       | 4       | V          |
| Grid 1 pulse $V_{g1p}$        | 28                | 24                            | 28      | 24      | V          |
| Grid 3 pulse $V_{g3p}$        |                   |                               |         |         | see note 8 |
| Faceplate illuminance         | 0 to 10 lx        |                               |         |         | 11         |
| Faceplate temperature         | 20 to 45 °C       |                               |         |         | 2          |

**ELECTRON GUN CHARACTERISTICS**

Cut off

Grid 1 voltage for cut-off at  $V_{g2,4} = 300$  V,  
without blanking or ACT pulses

$V_{g1}$  -40 to -110 V

Blanking voltage, peak to peak at  $V_{g2,4} = 300$  V  
on grid 1

$V_{g1p-p}$   $50 \pm 10$  V 12

Grids 2 and 4 current

$I_{g2,4}$  < 0,2 mA 13

Grids 3, 5 and 6 current

$I_{g3,5,6}$  13

Pulse timing and amplitude requirements (ACT)

8

**PERFORMANCE**

Dark current, without light bias

$I_d$   $\leq$  1 nA

Sensitivity at colour temperature of illuminance = 2856 K

14

XQ1500, XQ1500L

min. 330 typ. 375  $\mu A/lm$

XQ1500R

min. 70 typ. 80  $\mu A/lmF$

XQ1500G

min. 135 typ. 155  $\mu A/lmF$

XQ1500B

min. 35 typ. 38  $\mu A/lmF$

XQ1503, XQ1505R

min. 75 typ. 100  $\mu A/lmF$

Gamma of transfer characteristics

0,95  $\pm$  0,05

Light transfer characteristics with ACT

see Fig. 2

Highlight handling

$\geq$  5 lens stops 15

Spectral response, max. at

approx. 500 nm

Spectral response, cut-off : XQ1500

approx. 650 nm

XQ1503

approx. 850 to 950 nm

XQ1505

approx. 750 nm

Spectral response curves

see Figs 3, 4 and 5



notes  
16**Resolution**

Modulation depth, i.e. uncompensated amplitude response at 400 TV lines at the centre of the picture. The figures shown represent the horizontal amplitude response as measured with a lens aperture  $f : 5,6$

Modulation transfer characteristics: see Figs 6 and 6a

|                                  | XQ1500<br>XQ1500L | XQ1500R | XQ1500G | XQ1500B | XQ1503R<br>XQ1505R |    |
|----------------------------------|-------------------|---------|---------|---------|--------------------|----|
| Highlight signal current $I_s$   | 200               | 100     | 200     | 100     | 100                | nA |
| Beam current $I_b$               | 400               | 200     | 400     | 200     | 200                | nA |
| Modulation depth at 400 TV lines |                   |         |         |         |                    |    |
| typ.                             | 50                | 40      | 50      | 55      | 50                 | %  |
| min.                             | 45                | 35      | 45      | 50      | 45                 | %  |

**Lag (typical values)**

17

Light source with a colour temperature of 2856 K. Appropriate filter inserted in the light path for the chrominance tubes R, G and B.

**LOW KEY CONDITIONS** (with light bias of 3 nA)

|                          | build-up lag          |        | decay lag             |        |
|--------------------------|-----------------------|--------|-----------------------|--------|
|                          | $I_s/I_b = 20/300$ nA |        | $I_s/I_b = 20/300$ nA |        |
|                          | 60 ms                 | 200 ms | 60 ms                 | 200 ms |
| XQ1500, XQ1500L, XQ1500G | 98%                   | ≈ 100% | 6%                    | 2%     |
| XQ1500R                  | 95%                   | ≈ 100% | 7%                    | 3%     |
| XQ1500B                  | 95%                   | ≈ 100% | 9%                    | 3,5%   |
| XQ1503R                  | 95%                   | ≈ 100% | 7%                    | 3%     |
| XQ1505R                  | 95%                   | ≈ 100% | 7%                    | 3%     |

Typical effect of light bias on build-up and decay lag under low key signal current and beam settings are shown in Figs 7 to 14.

18

Shading of light bias induced dark current

12,5%

19

MECHANICAL DATA

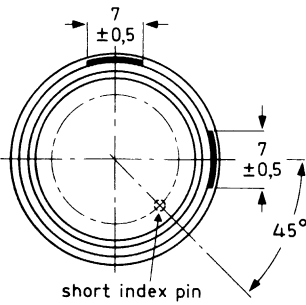
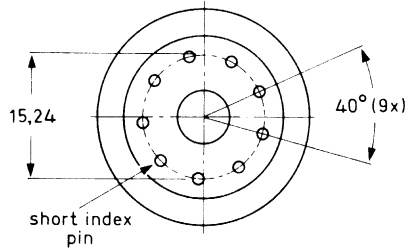
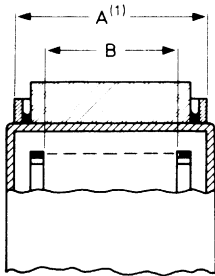
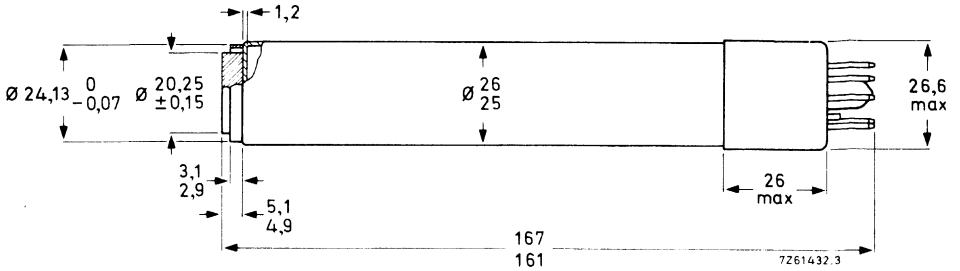

FRONT VIEW

7261433.3

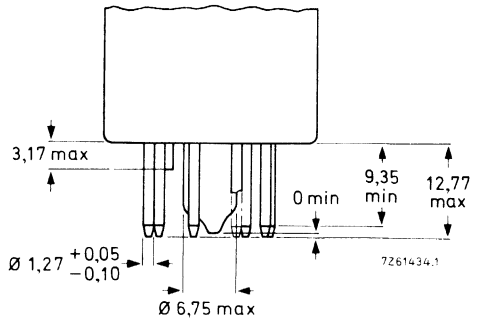

7261434.1

Mounting position: any

Mass:  $\approx 70$  g

Mase: IEC67-1-33a (JEDEC E8-11)

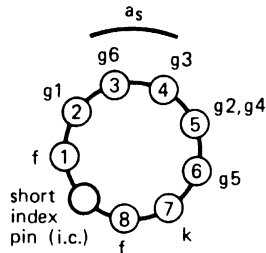

7261431.1

(1) The distance between the geometrical centres of the diameter A of the reference ring and the diameter B of the mesh-electrode ring is  $< 100 \mu\text{m}$ .

**NOTES**, see also General Section

1. The light bias lamp in its holder fits into the socket type 56026 and requires maximum 5 V, 110 mA. Its light is projected on to the pumping stem via a blue-green transmitting filter and is conducted to cause a bias illuminance on the target. The required amount of light bias can be obtained by adjusting the filament current of the lamp. See also note 18.
2. The tube can withstand short excursions up to 70 °C without damage or irreversible degradation in performance.
3. For short intervals. During storage the tube face shall be covered with the plastic hood provided; when the camera is idle the lens shall be capped, in stand-by also the beams will be cut-off.
4. The operating conditions and performance data quoted relate to operation of the tube in coil units AT1126 and AT1119. See relevant data of deflection/focusing assemblies.
5. When the tube is to be used without ACT action, grid 3 should be connected to grids 2 and 4 and no ACT pulses should be applied to the cathode and grid 1. The performance of the tube will then be as described herein with the exception of the highlight handling.
6.
  - a. For proper ACT action the d.c. voltage supply and/or pulse supply to the various electrodes should have sufficiently low impedance; see note 13.
  - b. Video preamplifier: In the presence of highlights, peak signal currents of the order of 15 to 45  $\mu\text{A}$  may be offered to the preamplifier during flyback. Special measures have to be taken in the preamplifier to prevent temporary overloading.
7.
  - a. Read-out mode: Defined as the operating conditions during the active line scan (full line period-line blanking interval). For the CCLR system this will amount to 64  $\mu\text{s}$  - 12  $\mu\text{s}$  = 52  $\mu\text{s}$ .
  - b. ACT mode: Defined as the operating conditions during that part of the line blanking interval during which the ACT electrode gun is fully operative. The ACT interval is equal to or slightly within the line flyback time.
8. Pulse timing (CCLR) and amplitudes for ACT action (blanking applied to grid 1, see note 12).
  - a. For proper operation and setting up of the ACT electron gun three electrodes have to be pulsed:
    - Cathode: A positive-going pulse,  $V_{kp}$ , with an adjustable amplitude of 0 to 20 V. this pulse can be chosen to coincide with the camera blanking period (approx. 11  $\mu\text{s}$ ). The amplitude of this pulse determines the ACT cutting level and may in general be preset to 8, 4, 8 and 4 V, for black/white, R, G, and B application respectively. An amplitude of 20 V should be available to preset the  $I_s/I_b$ ; see note 10.
    - Grid 1: A positive-going pulse,  $V_{g1p}$ , with such an amplitude that during the ACT mode the grid 1 bias is effectively reduced by 20 V, ( $V_{g1p} = 20 \text{ V} + V_{kp}$ ), to produce an extra amount of cathode current. The duration of this pulse should be so chosen that it is just within the flyback period (approx. 5  $\mu\text{s}$ ).
    - Grid 3: A negative-going pulse,  $V_{g3p}$ , timing and duration coinciding with  $V_{g1p}$ , with:
      - either and adjustable amplitude and superimposed on a fixed grid 3 voltage of 250 to 300 V,
      - or with fixed amplitude and superimposed on an adjustable grid 3 voltage of 250 to 300 V, in either case, adjusted to result in a grid 3 voltage of 8,5 V with respect to the cathode voltage during the ACT mode. This pulse ensures that an adequate amount of beam current is drawn from the cathode current.
  - b. A suggested pulse timing and amplitude diagram is shown in Fig. 1.
9. Operation with ACT at  $V_{g6} > 750 \text{ V}$  is not recommended since this may introduce dark current.

10. Adjusted with the ACT made inoperative, e.g. by setting the cathode pulse to 20 V. The control grid voltage is adjusted to produce a beam current just sufficient to allow a peak signal current of twice the typical value,  $I_{sp}$ , as observed and measured on a waveform oscilloscope. This amount of beam current is termed  $I_{bp}$ .  $I_b$  is set at 200 nA for R and B tubes and at 400 nA for L and G tubes.

N.B. The signal current,  $I_s$ , and the beam current,  $I_b$ , conditions quoted with the performance figures for e.g. lag relate to measurements with an integrating instrument connected in the signal electrode lead and a uniform illuminance on the scanned area. The corresponding peak currents,  $I_{sp}$  and  $I_{bp}$ , as measured on a waveform oscilloscope will be a factor  $\alpha$  larger.

( $\alpha = 100 / (100 - \beta)$ ;  $\beta$  being the total blanking time in %; for CCIR system  $\alpha = 1,3$ ).

11. Typical faceplate illumination level for the XQ1080 and XQ1080L to produce 200 nA signal current will be approx. 4,3 lx. The signal currents stated for the colour tubes R, G and B will be obtained with an incident white light level (2856 K) on the filter of approx. 11 lx. These figures are based on the filters described in note 14. For filter BG12, however, a thickness of 1 mm is chosen.
12. Blanking can also be applied to the cathode:
- without ACT action; required cathode pulse approx. 25 V
  - with ACT action; timing, polarity and amplitudes of the ACT pulses will have to be adapted.
13. The d.c. voltage supply and/or pulse supply to these electrodes should have a sufficiently low impedance to prevent distortion caused by the peak currents drawn during the ACT mode. These peak currents may amount to:

|               |             |
|---------------|-------------|
| cathode       | 2 mA        |
| grid 1        | 0 mA        |
| grids 2 and 4 | 1 mA        |
| grid 3        | 150 $\mu$ A |
| grid 5        | 300 $\mu$ A |
| grid 6        | 300 $\mu$ A |

The cathode impedance should preferably be chosen  $\leq 300 \Omega$ .

14. Measuring conditions: illuminance level 4,54 lx at a colour temperature of 2856 K and the appropriate filter inserted in the light path. The signal current obtained in nA is a measure of the colour sensitivity expressed in  $\mu$ A per lumen of white light before the filter. Filters used are:

|                  |             |       |           |      |
|------------------|-------------|-------|-----------|------|
| XQ1500R, XQ1505R | Schott      | OG570 | thickness | 3 mm |
| XQ1500G          | Schott      | VG9   | thickness | 1 mm |
| XQ1500B          | Schott      | BG12  | thickness | 3 mm |
| XQ1503R          | Schott      | OG570 | thickness | 3 mm |
|                  | and Calflex | B1/K1 |           |      |

For transmission curves see General Section.

15. With pulses applied as indicated in note 8 the tube will properly handle a highlight with a diameter of 10% of picture height and with a luminance corresponding to 32 times peak signal white,  $I_{sp}$ .
16. As measured with a 50 mm Leitz Summicron lens having a sine response of approximately 85% at 400 TV lines at  $f : 5,6$  and the appropriate filter inserted in the light path. The horizontal amplitude response can be raised by means of suitable correction circuits, which affect neither the vertical resolution nor the limiting resolution.
17. **Build-up lag**

After 10 s of darkness. The figures are typical percentages of the ultimate signal current obtained 60 ms and 200 ms, respectively, after the introduction of the illuminance.

**Decay lag**

After the target has been illuminated for at least 5 s. The figures represent typical signals in percentages of the original signal current 60 ms and 200 ms, respectively, after removal of the illuminance.

18. A reduction of lag, especially under low key conditions is obtained when light bias is applied. Infrared light with a wavelength  $> 600$  nm in the light bias should be avoided.
  - a. For monochrome operation a light bias corresponding to 2 to 3 nA dark current is usually adequate for excellent speed of response.
  - b. Adjustable light bias (colour camera).

In a colour camera the speeds of response of the tubes can be balanced by adjusting the amount of light bias per tube.

In a 3-tube colour camera for instance it is recommended to first adjust the tubes to their normal highlight signal current and beam current settings and then point the camera at a dark scene comprising a metronome. The moving hand of the metronome carries a small white square. The illuminance should be chosen such that the square produces a peak signal of approximately 50 nA in the green chrominance channel. A maximum of 3 nA artificial dark current shall then be introduced in green chrominance tube. Subsequently light bias shall be applied to the tubes in the red and blue channels until the lag of the three tubes is neutralized. A typical setting for correct speeds of response in a 3-tube colour camera would be approximately 3 nA(p) (R), 2nA(p) (G) and 3,5 nA(p) (B).
19. Deviation of the level of any of the four corners, i.e. 10% inwards in H and V direction from the level in the picture centre. With the settings suggested in note 18 black shading compensation in the camera video processing amplifier will not normally be required. Further improvement in lag can be obtained by applying still higher light bias levels. It may then be necessary to use black shading compensation in the video processing amplifier.

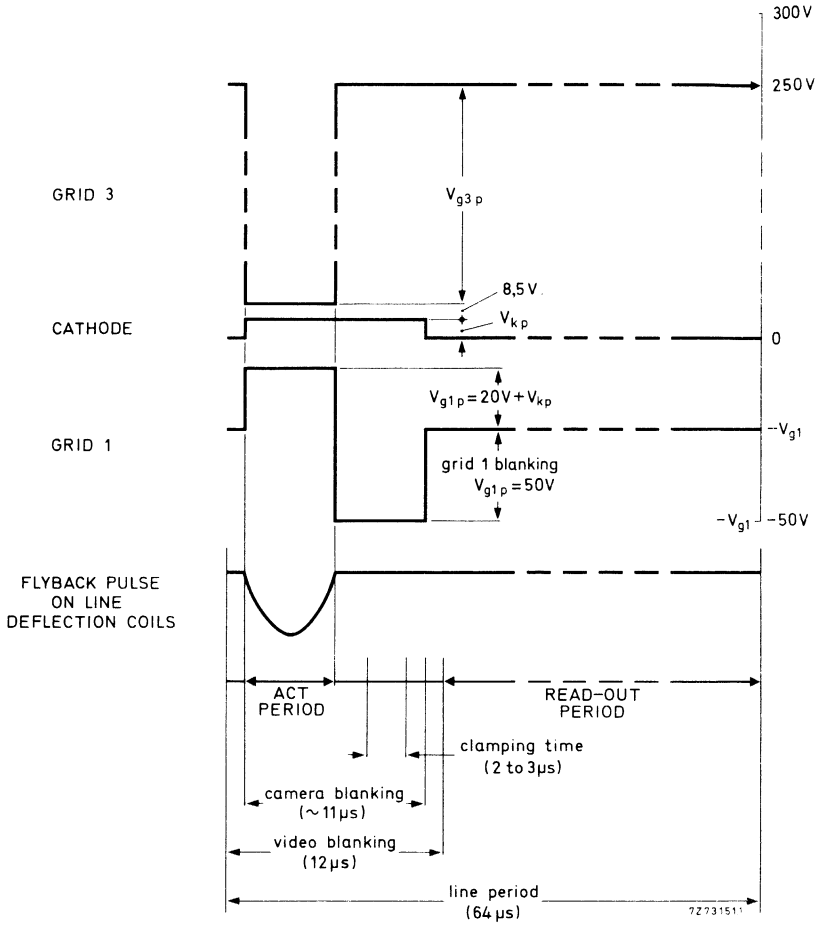

Fig. 1 Pulse timing and amplitude diagram.

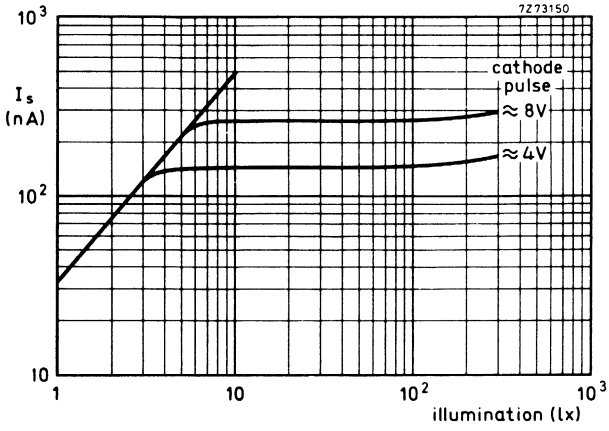

Fig. 2 Typical light transfer characteristics with ACT applied.

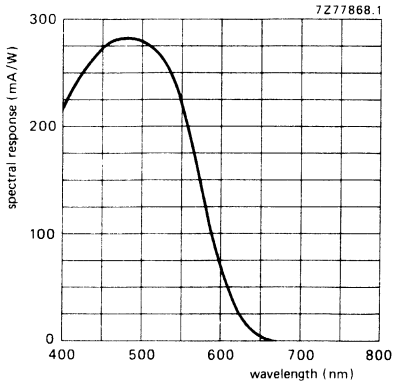

Fig. 3 Typical spectral response for XQ1500.

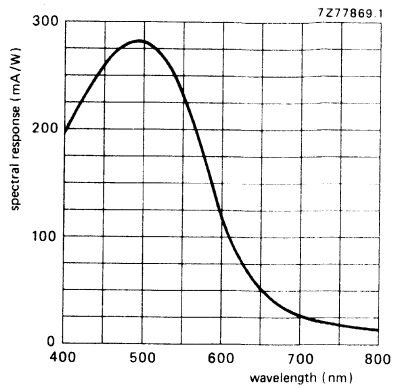

Fig. 4 Typical spectral response for XQ1503R.

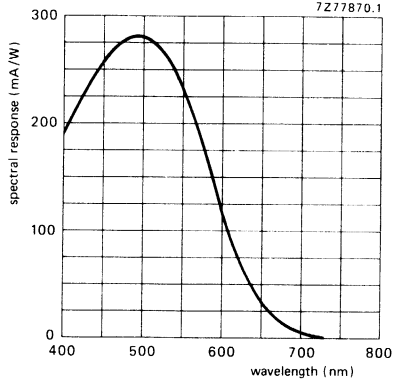

Fig. 5 Typical spectral response for XQ1505R.

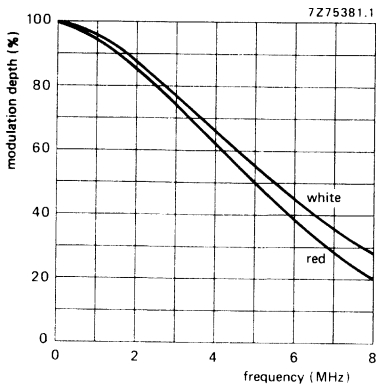

Fig. 6 Typical square-wave response curves for XQ1503R, XQ1505R.

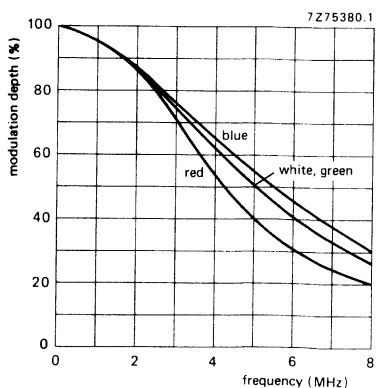

Fig. 6a Typical square-wave response curves for XQ1500.



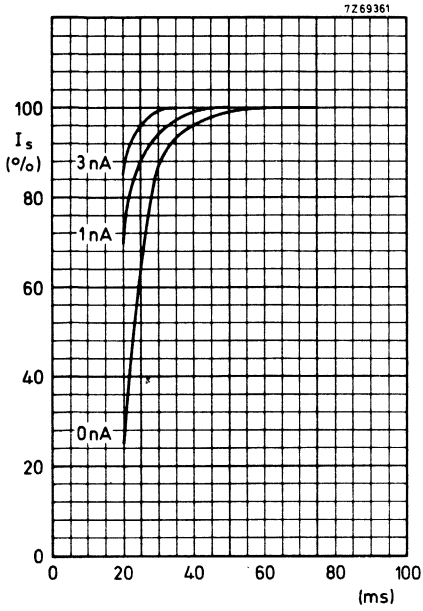

Fig. 7.

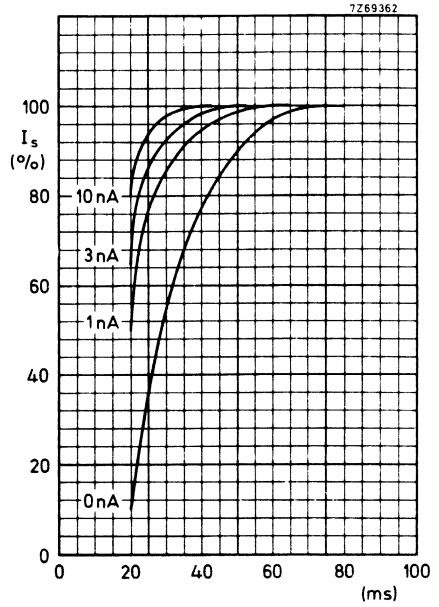

Fig. 8.

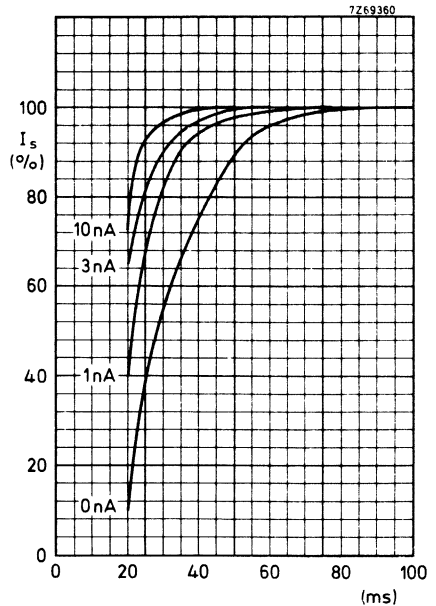

Fig. 9.

**Build-up lag** (see note 17)

Light bias induced dark current as parameter.

Fig. 7 XQ1500, XQ1500L, XQ1500G.  $I_s/I_b = 40/400$  nA.

Fig. 8 XQ1500R.  $I_s/I_b = 20/200$  nA.

Fig. 9 XQ1500B.  $I_s/I_b = 20/200$  nA.

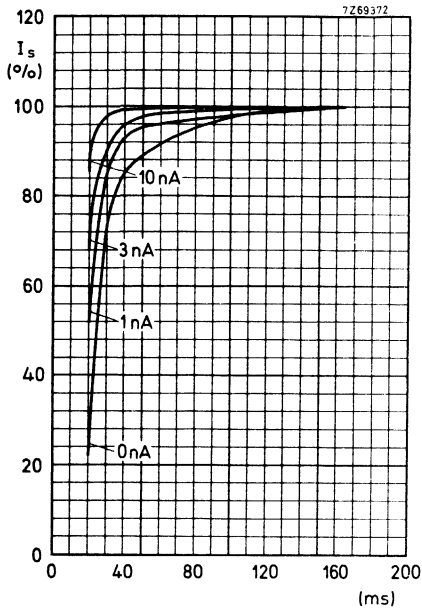

Fig. 10.

**Build-up lag** (See note 17)

Light bias induced dark current as parameter  
 XQ1503R, XQ1505R;  
 $I_s/I_b = 20/200$  nA.

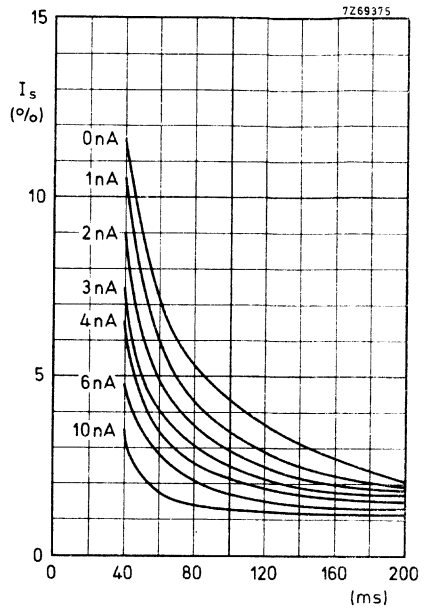

Fig. 11.

**Decay lag** (See note 17)

Light bias induced dark current as parameter  
 XQ1503R, XQ1505R;  
 $I_s/I_b = 20/200$  nA.

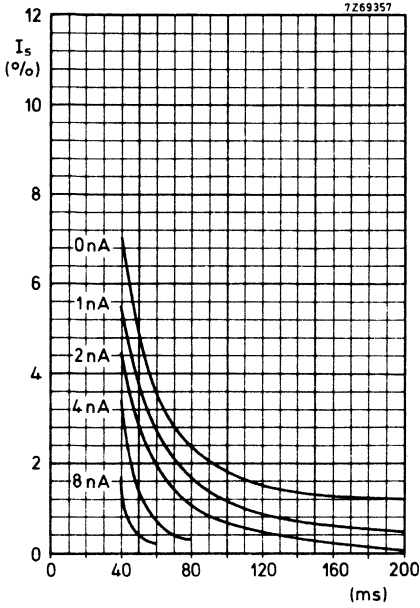

Fig. 12.

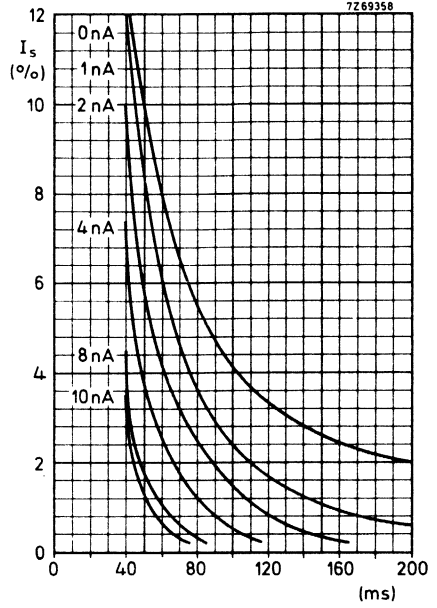

Fig. 13.

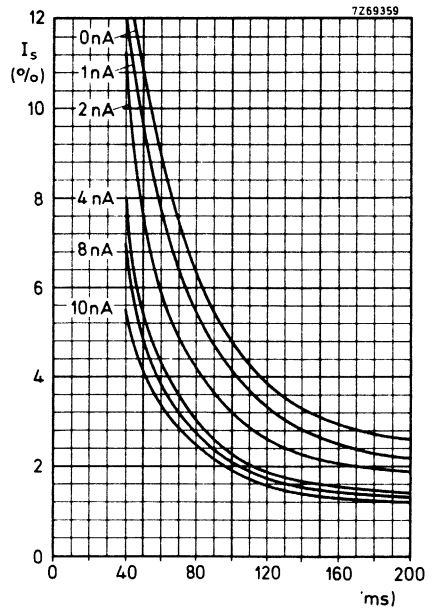

Fig. 14.

**Decay lag** (see note 17)

Light bias induced dark current as parameter

Fig. 12 XQ1500, XQ1500L, XQ1500G.  $I_s/I_b = 40/400$  nA.

Fig. 13 XQ1500R.  $I_s/I_b = 20/200$  nA.

Fig. 14 XQ1500B.  $I_s/I_b = 20/200$  nA.



## CAMERA TUBES

25,4 mm (1 inch) diameter Plumbicon® television camera tubes, with high resolution lead-oxide photoconductive target, for use in high quality monochrome or colour cameras for broadcast, educational or industrial applications.

The XQ1510 series comprises the following versions:

|         |   |
|---------|---|
| XQ1510  | for use in monochrome cameras                                   |
| XQ1510L | for use in the luminance channel of colour cameras              |
| XQ1510R | for use in the red channel                                      |
| XQ1510G | for use in the green channel                                    |
| XQ1510B | for use in the blue channel                                     |
| XQ1513R | for use in the red channel; extended red response               |
| XQ1515R | for use in the red channel; extended red response and IR filter |

The tubes of the XQ1510 series are provided with ACT electron gun and provisions for light bias like the tubes of the XQ1500 series but are front loading types.

The electrical and mechanical data of the tubes are identical to those of the XQ1500 series with the following exceptions.

## ELECTRICAL DATA

## Capacitance

|                         |          |           |
|-------------------------|----------|-----------|
| Signal electrode to all | $C_{as}$ | 3 to 5 pF |
|-------------------------|----------|-----------|

## ACCESSORIES

|                                   |           |
|-----------------------------------|-----------|
| Deflection and focusing coil unit | AT1116/06 |
|-----------------------------------|-----------|

MECHANICAL DATA

Dimensions in mm

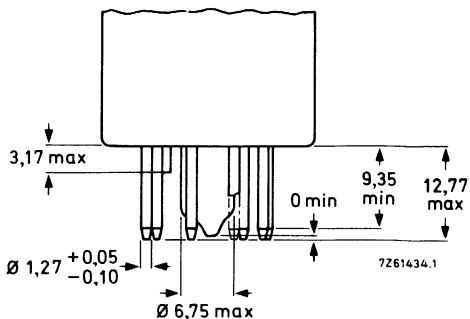
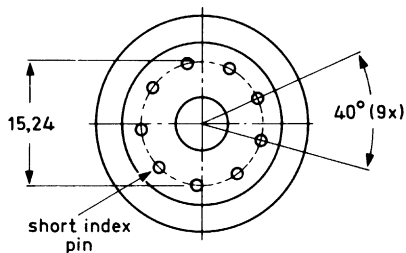
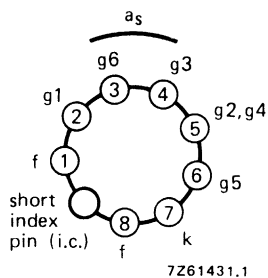
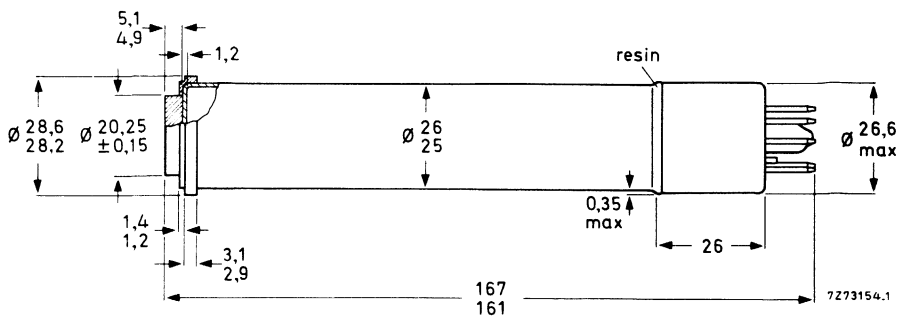

## CAMERA TUBES

25,4 mm (1 inch) diameter Plumbicon® television camera tubes, with high resolution lead-oxide photoconductive target, for use in high quality monochrome or colour cameras for broadcast, educational or industrial applications.

The XQ2070 series comprises the following versions:

|         |   |
|---------|---|
| XQ2070  | for use in monochrome cameras   |
| XQ2070L | for use in the luminance channel of colour cameras  |
| XQ2070R | for use in the red channel  |
| XQ2070G | for use in the green channel  |
| XQ2070B | for use in the blue channel   |
| XQ2071  | as XQ2070 series; only difference being the degree of freedom from blemishes on the target (industrial quality tubes) |
| XQ2073R | for use in the red channel; extended red response   |
| XQ2074  | as XQ2073. Industrial grade   |
| XQ2075R | for use in the red channel; extended red response and IR filter   |
| XQ2076  | as XQ2075. Industrial grade   |

These tubes are available in rear loading (/02 and /05) and front loading (/03) versions.

Special features are:

- New photoconductive target for increased resolution,
- "Diode" electron gun with high beam reserve for dynamic beam control (DBC) to minimize comet-tailing and blooming (notes 1, 2, 3)
- Provision for light bias to reduce lag (except types XQ . . . /05)

## QUICK REFERENCE DATA

|  |                       |
|--|-----------------------|
| "Diode" electron gun                   |                       |
| Diameter                               | 25,4 mm (1 inch)      |
| Length                                 | approx. 170 mm        |
| Provided with anti-halation glass disc |                       |
| Focusing                               | magnetic              |
| Deflection                             | magnetic              |
| Useful target area (scanning area)     | 9,6 x 12,8 mm         |
| Spectral response                      |                       |
| max. at                                | approx. 500 nm        |
| cut-off: XQ2070                        | approx. 650 nm        |
| XQ2073                                 | approx. 850 to 950 nm |
| XQ2075                                 | approx. 750 nm        |
| Sensitivity                            |                       |
| XQ2070, XQ2070L                        | typ. 350 $\mu$ A/lm   |
| XQ2070R                                | typ. 70 $\mu$ A/lmF   |
| XQ2070G                                | typ. 145 $\mu$ A/lmF  |
| XQ2070B                                | typ. 38 $\mu$ A/lmF   |
| XQ2073R, XQ2075R                       | typ. 100 $\mu$ A/lmF  |
| Resolution at 400 TV lines (5 MHz)     |                       |
| XQ2070, XQ2070L                        | typ. 60 %             |
| XQ2070R                                | typ. 45 %             |
| XQ2070G                                | typ. 60 %             |
| XQ2070B                                | typ. 60 %             |
| XQ2073R, XQ2075R                       | typ. 55 %             |
| Heater                                 | 6,3 V, 95 mA          |

® Registered trade mark for television camera tubes.

## MECHANICAL VARIANTS

notes

Variants are defined by a suffix as follows:

XQ . . . /02, R,G,B,L: rear loading versions with provision for internal light bias, target contact ring with 2 target contacts, metal sleeve on pumping stem to mount bias lamp.

XQ . . . /03, R,G,B,L: front loading versions with provision for internal light bias, metal ring target contact, metal sleeve on pumping stem to mount bias light lamp.

XQ . . . /05, R,G,B,L: as/02, however without provision for light bias.

## OPTICAL DATA

Quality rectangle on photoconductive target (aspect ratio 3 : 4) 9,6 x 12,8 mm

Orientation of image on target:

For correct orientation of the image on the target the vertical scan should be essentially parallel to the plane passing through the tube axis and the marker line on the protecting sleeve at the base.

Faceplate

Thickness 1,2 ± 0,1 mm  
 Refractive index n = 1,49

Anti-halation glass disc provided with anti-reflective coating

Thickness 5 ± 0,1 mm  
 Refractive index n = 1,52

XQ2075R is provided with infrared reflecting filter

## ACCESSORIES

|  |                |               |
|--|----------------|---------------|
| Socket   | type 56098     |               |
| Deflection and focusing coil unit:                 | rear loading   | front loading |
| Black/white  | type AT1119/01 | AT1116/06S    |
| Colour   | type AT1126T   | AT1116/06T    |
| Mask for flare reduction                           | type 56028     |               |
| Light bias lamp in holder for versions /02 and /03 | type 56106     | 4             |

## ELECTRICAL DATA

|  |            |             |
|--|------------|-------------|
| Deflection   | magnetic   |             |
| Focusing   | magnetic   |             |
| Heating, indirect by a.c. or d.c.; parallel supply   |            |             |
| Heater voltage   | $V_f$      | 6,3 V ± 5%  |
| Heater current at $V_f = 6,3$ V  | $I_f$ nom. | 95 mA       |
| The heater current and the heater voltage must not exceed r.m.s. values of 150 mA and 9,5 V. For optimum performance (lifetime and registration stability) stabilization of the heater voltage is recommended. |            |             |
| Capacitance  |            |             |
| Signal electrode to all rear loading types   | $C_{as}$   | 2,5 to 4 pF |
| front loading types  | $C_{as}$   | 3 to 5 pF   |
| This capacitance, which is effectively the output impedance, increases when the tube is inserted in the coil unit.   |            |             |



**LIMITING VALUES** (Absolute maximum rating system)

notes

Unless otherwise stated, all voltages are referred to the cathode.

|  |             |      |              |   |
|--|-------------|------|--------------|---|
| Signal electrode voltage                     | $V_{as}$    | max. | 50 V         |   |
| Grid 4 voltage                               | $V_{g4}$    | max. | 1100 V       |   |
| Grid 3 voltage                               | $V_{g3}$    | max. | 800 V        |   |
| Voltage between grid 4 and grid 3            | $V_{g4/g3}$ | max. | 450 V        |   |
| Grid 2 voltage                               | $V_{g2}$    | max. | 340 V        |   |
| Grid 1 voltage,                              |             |      |              |   |
| positive                                     | $V_{g1}$    | max. | 25 V         |   |
| negative                                     | $-V_{g1}$   | max. | 200 V        |   |
| Grid 1 current ( $\approx I_k$ current)      | $I_{g1}$    | max. | 5 mA         |   |
| Grid 1 current (peak to peak with DBC)       | $I_{g1p}$   | max. | 8 mA         | 2 |
| Cathode heating time before drawing          |             |      |              |   |
| cathode current                              | $t_h$       | min. | 1 min        |   |
| Cathode to heater voltage                    |             |      |              |   |
| positive peak                                | $V_{kfp}$   | max. | 125 V        |   |
| negative peak                                | $-V_{kfp}$  | max. | 50 V         |   |
| Cathode heating time before                  |             |      |              |   |
| drawing current                              | $t_h$       | min. | 1 min        |   |
| External resistance between cathode          |             |      |              |   |
| and heater at $V_{kfp} > 10$ V               | $R_{kf}$    | min. | 2 k $\Omega$ |   |
| Ambient temperature, storage and operation   | $T_{amb}$   | max. | 50 °C        |   |
|  |             | min. | -30 °C       |   |
| Faceplate temperature, storage and operation | $T$         | max. | 50 °C        |   |
|  |             | min. | -30 °C       |   |
| Faceplate illuminance                        | $E$         | max. | 500 lx       | 5 |

**OPERATING CONDITIONS**

6

For a scanned area of 9,6 x 12,8 mm

|  |             |             |   |
|--|-------------|-------------|---|
| Cathode voltage                          | $V_k$       | 0 V         |   |
| Signal electrode voltage                 | $V_{as}$    | 45 V        |   |
| Beam current                             | $I_b$       |             | 7 |
| Grid 4 voltage                           | $V_{g4}$    | 960 V       |   |
| Grid 3 voltage                           | $V_{g3}$    | 600 V       |   |
| Grid 2 voltage                           | $V_{g2}$    | 300 V       |   |
| Grid 1 voltage                           | $V_{g1}$    | V           | 7 |
| Blanking voltage on grid 1, peak to peak | $V_{g1p-p}$ | 25 V        |   |
| Faceplate illuminance                    | $E$         | 0 to 10 lx  | 8 |
| Faceplate temperature                    | $T$         | 20 to 45 °C | 9 |

**ELECTRON GUN CHARACTERISTICS**

Cut off

|   |             |               |   |
|---|-------------|---------------|---|
| Grid 1 voltage for cut-off at $V_{g2} = 300$ V,<br>without blanking | $V_{g1}$    | -10 to 0 V    |   |
| Grid 1 voltage for normal beam setting                              | $V_{g1w}$   | $\leq$ 15 V   |   |
| Blanking voltage, peak to peak                                      |             |               |   |
| on grid 1   | $V_{g1p-p}$ | 25 V          |   |
| on cathode  | $V_{kp-p}$  | 25 V          |   |
| Grid 1 current at normally required                                 |             |               |   |
| beam currents   | $I_{g1}$    | $\leq$ 1,5 mA | 2 |
| Grid 2 current at normally required                                 |             |               |   |
| beam currents   | $I_{g2}$    | $\leq$ 0,1 mA | 2 |

## PERFORMANCE

|   |                                     |       |
|---|-------------------------------------|-------|
| Dark current  | $I_d \leq 2 \text{ nA}$             | notes |
| Sensitivity at colour temperature of illuminance = 2856 K   |                                     | 10    |
| XQ2070,L  | min. 300 typ. 350 $\mu\text{A/lm}$  |       |
| XQ2070R   | min. 63 typ. 70 $\mu\text{A/lmF}$   |       |
| XQ2070G   | min. 130 typ. 145 $\mu\text{A/lmF}$ |       |
| XQ2070B   | min. 35 typ. 38 $\mu\text{A/lmF}$   |       |
| XQ2073R, XQ2075R  | min. 80 typ. 100 $\mu\text{A/lmF}$  |       |
| Gamma of transfer characteristics   | $0,95 \pm 0,05$                     |       |
| Spectral response, max. at  | 500 nm                              |       |
| Spectral response, cut-off at   | 650 to 950 nm                       |       |
| Spectral response curves  | see Figs 1, 2                       |       |
| Resolution  |                                     | 11    |
| Modulation depth, i.e. uncompensated amplitude response at 400 TV lines at the centre of the picture. |                                     |       |

|                                  | XQ2070,L<br>XQ2070G | XQ2070R | XQ2070B | XQ2073R<br>XQ2075R | 7,11 |
|----------------------------------|---------------------|---------|---------|--------------------|------|
| Highlight signal current $I_s$   | 200                 | 100     | 100     | 100                | nA   |
| Beam current $I_b$               | 400                 | 200     | 200     | 200                | nA   |
| Modulation depth at 400 TV lines |                     |         |         |                    |      |
| typ.                             | 60                  | 45      | 60      | 55                 | %    |
| min.                             | 55                  | 40      | 55      | 50                 | %    |

Modulation transfer characteristics: see Figs 3 and 4

Lag (typical values, with light bias of 3 nA)

4,12

Light source with a colour temperature of 2856 K. Appropriate filter inserted in the light path for the chrominance tubes R, G and B

## LOW KEY CONDITIONS

|                  | build-up lag                  |                 | decay lag                     |        |
|------------------|-------------------------------|-----------------|-------------------------------|--------|
|                  | $I_s/I_b = 20/300 \text{ nA}$ |                 | $I_s/I_b = 20/300 \text{ nA}$ |        |
|                  | 60 ms                         | 200 ms          | 60 ms                         | 200 ms |
| XQ2070           | 95%                           | $\approx 100\%$ | 9%                            | 2,5%   |
| XQ2070G          | 95%                           | $\approx 100\%$ | 9%                            | 2,5%   |
| XQ2070R          | 95%                           | $\approx 100\%$ | 9%                            | 2,5%   |
| XQ2070B          | 90%                           | $\approx 100\%$ | 12%                           | 4%     |
| XQ2073R, XQ2075R | 90%                           | $\approx 100\%$ | 11%                           | 3%     |

Shading of light bias induced dark current

12,5%

14

Highlight handling capacity with DBC

15

MECHANICAL DATA

Rear loading tubes XQ2070/02

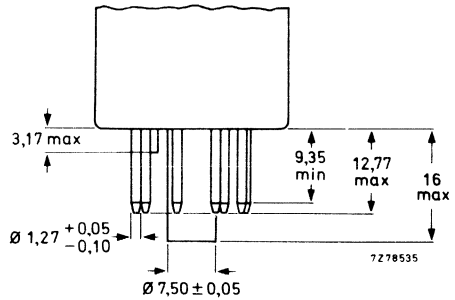
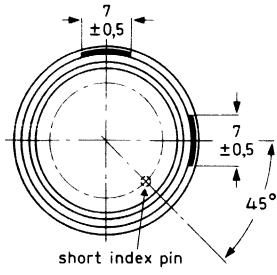
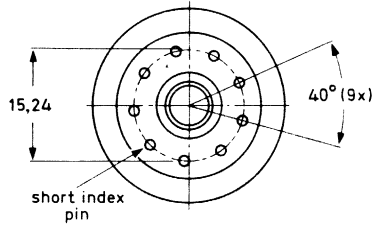
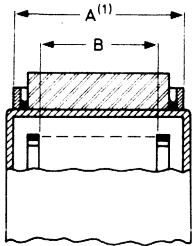
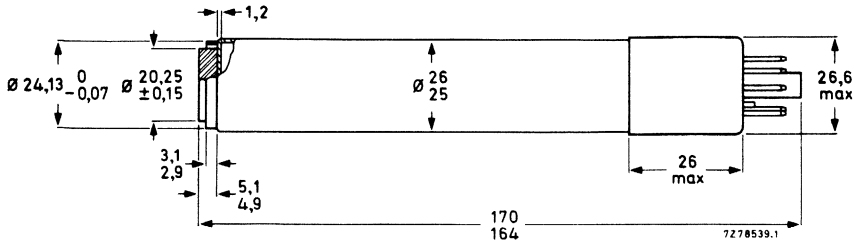

FRONT VIEW

7261433.3

(1) The distance between the geometrical centres of diameter A of the reference ring and diameter B of the mesh electrode ring is  $< 100 \mu\text{m}$ .

Mounting position: any

Mass:  $\approx 70 \text{ g}$

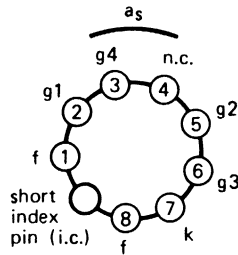

7268427.1



Rear loading tubes XQ2070/05

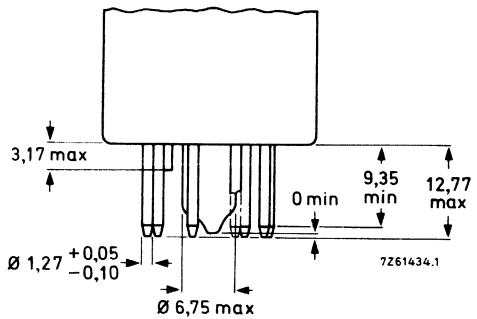
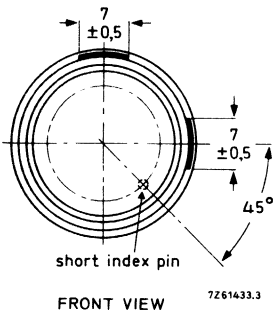
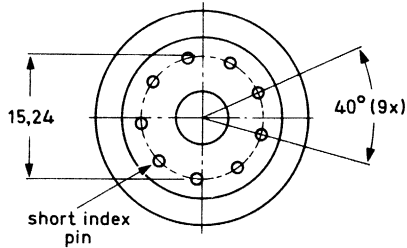
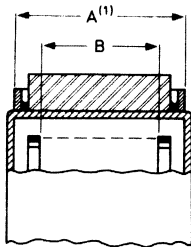
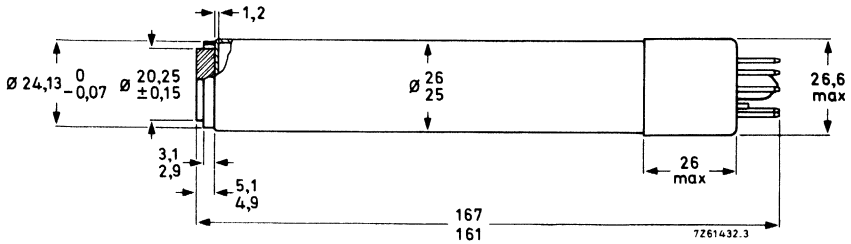

(1) The distance between the geometrical centres of diameter A of the reference ring and diameter B of the mesh electrode ring is < 100 μm.

Mounting position: any

Mass: ≈ 70 g

Base: IEC 67-1-33a (JEDEC E8-11)

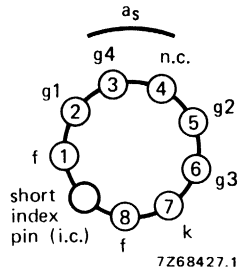

**NOTES**, see also General Section

1. "Diode" electron gun is a triode gun operating in a diode mode, providing a very high beam reserve.  
N.B. Avoid continuous operation at high beam currents since this will shorten tube life. Full advantage of the high beam reserve to reduce comet-tailing and blooming can be made with DBC circuitry which, during highlights, feeds positive-going pulses derived from the video signal to grid 1, to increase the beam current momentarily.
2. The "diode" gun operates with a positive ( $\leq 15$  V) grid 1 voltage (adjusted for correct beam settings, see note 7), hence draws some grid 1 current:  
without DBC:  $\leq 1,5$  mA (peak) with blanking  
with DBC:  $\leq 8$  mA (peak) with blanking measured with oscilloscope.  
The DBC circuitry should, in the case of highlights, supply positive-going pulses of 7 V above  $V_{g1w}$  (see note 12) and up to 8 mA peak to grid 1.  
N.B. Applying higher pulses than 7 V is not recommended since this will shorten tube life, impair resolution and may introduce oscillations.
3. The rear loading tubes closely resemble mechanically the tubes of the XQ1080/XQ1500 series. The front loading types resemble the tubes of the XQ1070 series. Since, however, the "Diode" electron gun draws some grid 1 current (see note 2), cameras designed around XQ1080/XQ1500 and XQ1070 tubes will require some modification.
4. For adjustable light bias in versions /02 and /03. The light bias lamp assembly as supplied with these tubes, type 56106, fits in the metal tube cemented to the pumping stem of the tube. The tube and the light bias lamp assembly will fit properly in the socket, type 56098. The wires should be connected to a source, capable of supplying max. 110 mA at 5 V.  
The desired amount of light bias can be obtained by adjusting the current through the filament of the lamp. For black/white operation a light bias corresponding to 2 to 3 nA extra dark current is usually adequate for excellent speed of response. In a colour camera the speeds of response of the tubes can be balanced by adjusting the amount of light bias per tube. A typical setting in a 3-tube colour camera could be 3 nA (R), 2 nA (G), and 6 nA (B). Infrared light with a wavelength  $> 600$  nm in the light bias should be avoided.
5. For short intervals. During storage the tube face shall be covered with the plastic hood provided; when the camera is idle the lens shall be capped, in stand-by also the beam will be cut-off.
6. The operating conditions and performance data quoted relate to operation of the tube in coil unit AT1126 and AT1116. See relevant data of deflection/focusing assemblies.
7. The beam current  $I_b$ , as obtained by adjusting the control grid (grid 1) voltage is set for 1 stop over peak white and is 200 nA for R and B tubes, 400 nA for black/white and G tubes.  $I_b$  is not the total current available in the scanning beam, but is defined as the maximum amount of signal current,  $I_s$ , that can be obtained with this beam.  
In the performance figures e.g. for lag, the signal current and beam current conditions are given as  $I_s/I_b = 20/300$  nA. This means: with a signal current of 20 nA and a beam setting which just allows a signal current of 300 nA.
8. Typical faceplate illumination level for the XQ2070 and XQ2070L to produce 200 nA signal current will be approx. 4,6 lx. The signal currents stated for the colour tubes R, G and B will be obtained with an incident white light level (2856 K) on the filter of approx. 11 lx. These figures are based on the filters described in note 10. For filter BG12, however, a thickness of 1 mm is chosen.
9. The tube can withstand short excursions up to 70 °C without damage or irreversible degradation in performance.

10. Measuring conditions: illuminance level approx. 4,54 lx at a colour temperature of 2856 K and the appropriate filter inserted in the light path. Filters used are:

|                  |             |       |           |      |
|------------------|-------------|-------|-----------|------|
| XQ2070R, XQ2075R | Schott      | OG570 | thickness | 3 mm |
| XQ2070G          | Schott      | VG9   | thickness | 1 mm |
| XQ2070B          | Schott      | BG12  | thickness | 3 mm |
| XQ2073R          | Schott      | OG570 | thickness | 3 mm |
|                  | and Calflex | B1/K1 |           |      |

For transmission curves see General Section.

11. As measured with a 50 mm Leitz Summicron lens having a sine response of approximately 85% at 20,6 lp/mm (400 TV lines at 9,6 mm picture height) at  $f : 5,6$  and the appropriate filter inserted in the light path. The amplitude response can be raised by means of suitable correction circuits.
12. Adjusted for sum of dark current, leakage current and light bias current of 3 nA.
13. **Build-up lag**  
After 10 s of darkness. The figures are typical percentages of the ultimate signal current obtained 60 ms and 200 ms, respectively, after the introduction of the illuminance.
- Decay lag**  
After the target has been illuminated for at least 5 s. The figures represent typical signals in percentages of the original signal current 60 ms and 200 ms, respectively, after removal of the illuminance.
14. Deviation of the level of any of the four corners, i.e. 10% inwards in L and V direction, from the level in the picture centre. The observed shading is composed of slight parabolic and sawtooth components in both line and frame direction which can be sufficiently compensated by suitable black shading compensation circuitry.
15. a. With DBC applied (see note 2) the tube will properly handle highlights with a diameter of 10% of the picture height and with a brightness corresponding to 16 times peak signal white,  $I_{sp}$ .  
b. The maximum peak signal currents in the case of highlights will be 2,5  $\mu$ A. Video preamplifiers should be designed to accommodate these.

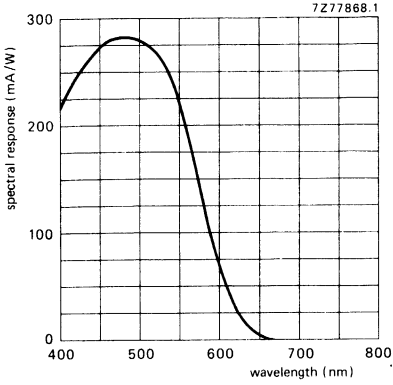

Fig. 1 Typical spectral response for XQ2070, R, G, B, L.

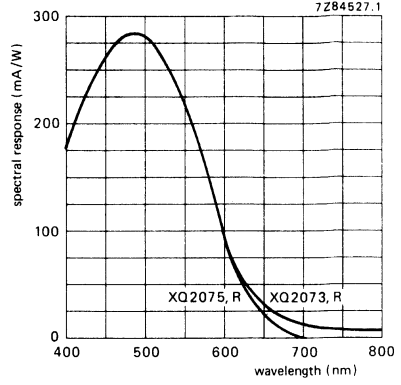

Fig. 2 Typical spectral responses for XQ2073R - XQ2075R.

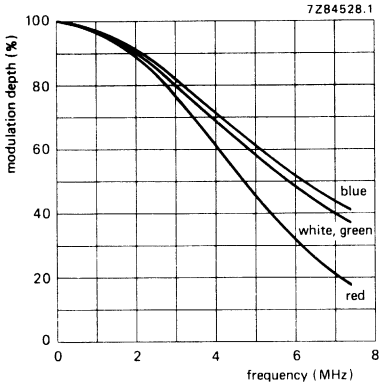

Fig. 3 Typical square-wave response curves for XQ2070.

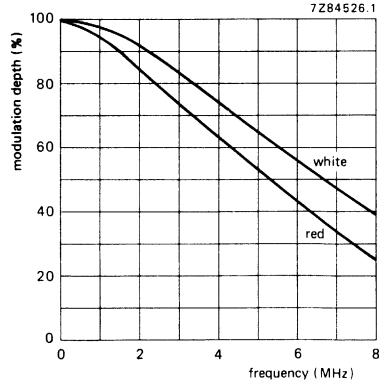

Fig. 4 Typical square-wave response curves for XQ2073/XQ2075.



## CAMERA TUBES

25,4 mm (1 inch) diameter Plumbicon® television camera tubes with high resolution lead-oxide photoconductive target, exclusively for use with X-ray image intensifiers with P20 output phosphor in medical equipment.

The XQ2172 series comprises the following versions:

XQ2172/02 Rear loading, with target centring ring and standard anti halation glass disc.

XQ2172/03 Front loading, with metal ring, without anti-halation glass disc.

XQ2172/03X Front loading, with metal ring and BG18 anti-halation glass disc.

Special features are:

- New photoconductive target for increased resolution;
- "Diode" electron gun with special cathode for high beam current operation, improved beam acceptance and low lag;
- Provision for light bias to reduce lag.

## QUICK REFERENCE DATA

"Diode" electron gun

|                                     |                      |
|-------------------------------------|----------------------|
| Diameter                            | 25,4 mm (1 in)       |
| Length                              | approx. 170 mm       |
| Focusing                            | magnetic             |
| Deflection                          | magnetic             |
| Useful target area, circle diameter | 16,2 mm              |
| Spectral response                   |                      |
| maximum at                          | ≈ 500 nm             |
| cut-off at                          | ≈ 850 to 950 nm      |
| Sensitivity with P20 light source   |                      |
| XQ2172/02                           | typ. 440 $\mu$ A/lmF |
| XQ2172/03                           | typ. 490 $\mu$ A/lmF |
| XQ2172/03X                          | typ. 465 $\mu$ A/lmF |
| Resolution                          | typ. 60%             |
| Heater                              | 6,3 V, 190 mA        |

® Registered Trade Mark for television camera tube.

# XQ2172 SERIES

## OPTICAL DATA

|   |                      |
|---|----------------------|
| Dimensions of quality area on photoconductive target  | circle, dia. 16,2 mm |
| Orientation of image on target  |                      |
| For correct orientation of the image on the target the vertical scan should be essentially parallel to the plane passing through the tube axis and the mark on the tube base. |                      |
| Faceplate   |                      |
| thickness   | 1,2 mm               |
| refractive index  | 1,49                 |
| Standard anti-halation glass disc (XQ2172/02)   |                      |
| thickness   | 5 mm                 |
| refractive index  | 1,52                 |
| BG18 anti-halation glass disc (XQ2172/03X)  |                      |
| thickness   | 1,07 mm              |
| refractive index  | 1,54                 |

## ACCESSORIES

|                                    |                 |
|------------------------------------|-----------------|
| Socket                             | type 56098      |
| Deflection and focusing coil unit, |                 |
| XQ2172/02                          | AT1119, AT1126S |
| XQ2172/03 (X)                      | AT1116S         |

## ELECTRICAL DATA

|                   |          |
|-------------------|----------|
| <b>Deflection</b> | magnetic |
| <b>Focusing</b>   | magnetic |

### Heating

Indirect by a.c. or d.c.

|                                  |       |                |
|----------------------------------|-------|----------------|
| Heater voltage                   | $V_f$ | 6,3 V $\pm$ 5% |
| Heater current, at $V_f = 6,3$ V | $I_f$ | 190 mA         |

The heater voltage must not exceed 9,5 V r.m.s. For optimum performance stabilization of the heater voltage is recommended.

### Capacitance

|                         |             |
|-------------------------|-------------|
| Signal electrode to all |             |
| XQ2172/02               | 2,5 to 4 pF |
| XQ2172/03               | 3 to 5 pF   |

These capacitances, which are effectively the output impedances, increase when the tubes are inserted in the coil unit.

**LIMITING VALUES** (Absolute maximum rating system)

All voltages are referred to the cathode, unless otherwise stated.

|  |             |              |                                     | notes |
|--|-------------|--------------|-------------------------------------|-------|
| Signal electrode voltage   | $V_{as}$    | max.         | 50 V                                |       |
| Grid 4 voltage (mesh)  | $V_{g4}$    | max.         | 1100 V                              |       |
| Grid 3 voltage   | $V_{g3}$    | max.         | 800 V                               |       |
| Voltage between grid 4 and grid 3                                      | $V_{g4/g3}$ | max.         | 450 V                               |       |
| Grid 2 voltage   | $V_{g2}$    | max.         | 350 V                               |       |
| Grid 1 voltage, positive   | $V_{g1}$    | max.         | 20 V                                |       |
| Grid 1 voltage, negative   | $-V_{g1}$   | max.         | 200 V                               |       |
| Grid 1 current ( $\approx$ cathode current)                            | $I_{g1}$    | max.         | 10 mA                               | 3     |
| Cathode to heater voltage, positive peak                               | $V_{kf p}$  | max.         | 50 V                                |       |
| Cathode to heater voltage, negative peak                               | $-V_{kfp}$  | max.         | 125 V                               |       |
| Cathode heating time before drawing cathode current                    | $t_h$       | min.         | 1 min                               |       |
| External resistance between cathode and heater<br>at $V_{kf p} > 10$ V | $R_{kf}$    | min.         | 2 k $\Omega$                        |       |
| Ambient temperature, storage and operation                             | $T_{amb}$   | max.<br>min. | 50 $^{\circ}$ C<br>-30 $^{\circ}$ C |       |
| Faceplate temperature, storage and operation                           | T           | max.<br>min. | 50 $^{\circ}$ C<br>-30 $^{\circ}$ C | 4     |
| Faceplate illuminance  | E           | max.         | 500 lx                              | 5     |

## OPERATING CONDITIONS AND PERFORMANCE

| Conditions                               |                     |             | notes |
|--|---------------------|-------------|-------|
| Cathode voltage                          | $V_k$               | 0 V         | 6     |
| Signal electrode voltage                 | $V_{as}$            | 45 V        |       |
| Beam current                             | $I_b$               |             | 7, 8  |
| Grid 4 voltage                           | $V_{g4}$            | 960 V       | 9     |
| Grid 3 voltage                           | $V_{g3}$            | 600 V       | 9     |
| Grid 2 voltage                           | $V_{g2}$            | 300 V       |       |
| Grid 1 voltage                           | $V_{g1}$            | 0 to 20 V   |       |
| Blanking voltage on grid 1, peak to peak | $V_{g1\text{ p-p}}$ | 30 V        |       |
| Focusing coil current                    |                     |             | 6     |
| Deflection and alignment currents        |                     |             | 6     |
| Faceplate illuminance (P20 light source) | E                   | 0 to 10 lx  |       |
| Faceplate temperature                    | T                   | 20 to 45 °C |       |

## ELECTRON GUN CHARACTERISTICS

|   |                     |                      |
|---|---------------------|----------------------|
| Grid 1 voltage for cut-off at $V_{g2} = 300\text{ V}$     | $V_{g1}$            | -10 to 0 V           |
| Grid 1 voltage for normal beam setting                    | $V_{g1w}$           | $\leq 20\text{ V}$   |
| Grid 1 current at normally required beam currents         | $I_{g1}$            | $\leq 5\text{ mA}$   |
| Grid 2 current at normally required beam currents         | $I_{g2}$            | $\leq 0,1\text{ mA}$ |
| Blanking voltage, peak to peak, with respect to $V_{g1w}$ | $V_{g1\text{ p-p}}$ | 30 V                 |

## Performance

|  |                   |                            |    |
|--|-------------------|----------------------------|----|
| Dark current                                     | $I_d$             | $< 2\text{ nA}$            |    |
| Sensitivity at colour temperature of 2856K       |                   |                            | 10 |
| XQ2172/02  | min. 130          | typ. 145 $\mu\text{A/lmF}$ |    |
| XQ2172/03  | min. 145          | typ. 155 $\mu\text{A/lmF}$ |    |
| XQ2172/03X                                       | min. 90           | typ. 110 $\mu\text{A/lmF}$ |    |
| Sensitivity with P20 light source                |                   |                            |    |
| XQ2172/02  | min. 395          | typ. 440 $\mu\text{A/lm}$  |    |
| XQ2172/03  | min. 440          | typ. 490 $\mu\text{A/lm}$  |    |
| XQ2172/03X                                       | min. 400          | typ. 465 $\mu\text{A/lm}$  |    |
| Peak signal current with $E = 1\text{ lx}$ (P20) |                   |                            | 11 |
| XQ2172/02  | $I_{sp}$ min. 185 | typ. 205 nA                |    |
| XQ2172/03  | $I_{sp}$ min. 210 | typ. 225 nA                |    |
| XQ2172/03X                                       | $I_{sp}$ min. 185 | typ. 215 nA                |    |
| Peak signal current (16,2 mm dia scanning)       |                   | 2000 nA                    | 7  |

|  |                        |    |
|--|------------------------|----|
| Gamma of transfer characteristic   | 0,95 ± 0,05            |    |
| Spectral response:   |                        |    |
| max. response at   | ≈ 500 nm               |    |
| cut-off at   | 800 to 950 nm          |    |
| response curves  | see Fig. 4             |    |
| Resolution   |                        | 12 |
| Modulation depth i.e. uncompensated amplitude response at 20,3 lp/mm (scanned area 9,6 x 12,8 mm) at the centre of the picture (5 MHz, 400 TV lines) | min. 50 %<br>typ. 60 % |    |
| Modulation depth at 12 lp/mm (scanned area 16,2 mm diameter) at the centre of the picture (5 MHz 400 TV lines)                                       | min. 70 %<br>typ. 80 % |    |
| Modulation transfer characteristic, see Fig. 7   |                        |    |
| Decay lag (no light bias applied) Fig. 6   |                        | 13 |
| Residual signal after dark pulse of 60 ms  | max. 18 %<br>typ. 12 % | 14 |
| Residual signal after dark pulse of 200 ms   | max. 7 %<br>typ. 4,5 % |    |
| Build-up lag (no light bias applied) Fig. 5  |                        | 13 |
| Signal current after 60 ms illumination  | min. 50 %<br>typ. 95 % | 15 |

## MECHANICAL DATA

### Rear loading tubes XQ2172/02

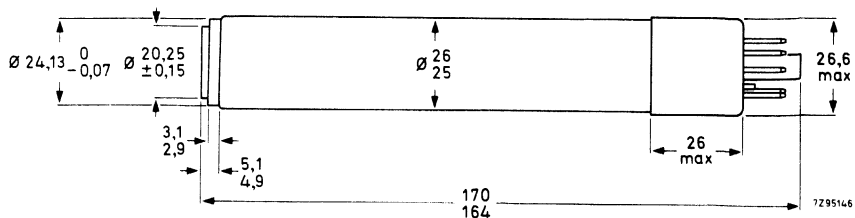

### Front loading tubes XQ2172/03

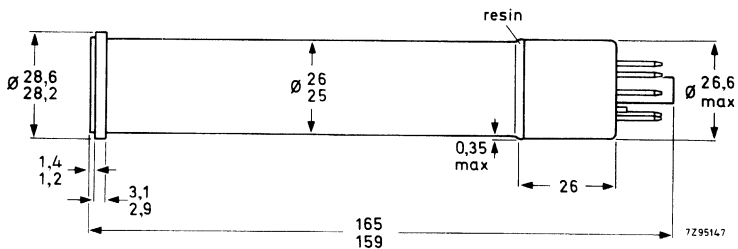

### Front loading tubes XQ2172/03X

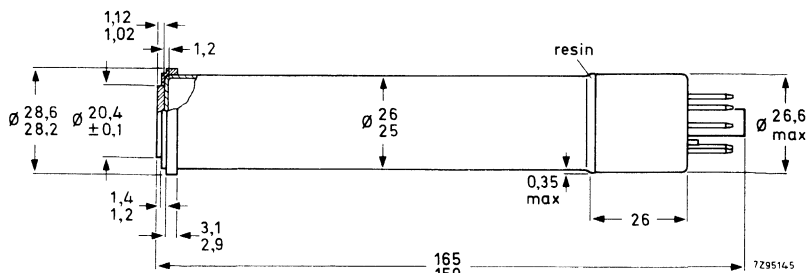
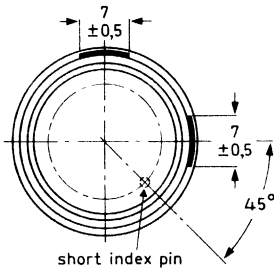
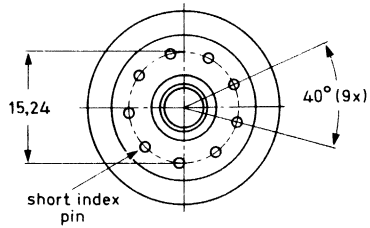
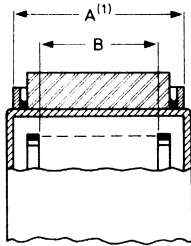

Fig. 1.

Mounting position: any

Mass:  $\approx 70$  g

Base: IEC 67-I-33a (JEDEC E8-11)



FRONT VIEW  
XQ2172/02

Fig. 2a.

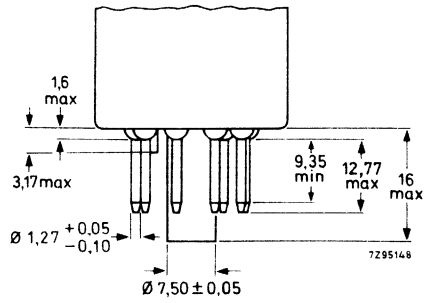

Fig. 2b.

(1) The distance between the geometrical centres of diameter A of the reference ring and diameter B of the mesh electrode ring is  $< 100 \mu\text{m}$ .

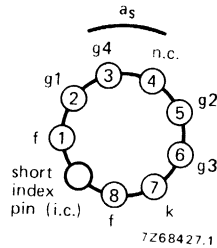

Fig. 2c.

## NOTES, see also General Section

1. The "Diode" gun operates with a positive grid 1 voltage, hence draws some grid current. The grid 1 voltage (d.c.) must be adjusted for correct beam current as described in note 8.
2. "Diode" gun is a triode gun operating in a diode mode, providing a very high beam reverse.  
Continuous operation with a high beam setting is to be avoided since this will shorten tube life. High  $I_b$  settings should be used under high light intensity conditions only. All other modes of operation should be normal  $I_b$  settings or have them cut off.
3. A current limiter must be incorporated to limit total cathode current to 10 mA maximum.
4. The tube can withstand short excursions up to 70.0°C without any damage or irreversible degradation in performance.
5. For short intervals. During storage the tube face shall be covered with the plastic hood provided; when the camera is idle the lens shall be capped, in stand-by also the beam will be cut-off.
6. The operating conditions and performance data quoted, relate to operation of the tube in coil units AT1116, AT1119 or AT1126. See relevant data of deflection/focusing assemblies. Scanning amplitude should be adjusted such that the useful target area of 16,2 mm dia. is displayed on a standard monitor as a circular area with a diameter equal to the raster height.
7. The maximum peak signal which can be handled is 3  $\mu$ A. Video amplifiers should be designed to accommodate this.
8. The beam current  $I_b$ , as obtained by adjusting the control grid voltage (grid 1) is set at 400 nA.  $I_b$  is not the total current available in the scanning beam, but is defined as the maximum amount of signal current  $I_s$ , that can be obtained with this beam.  
In the performance figures, e.g. for resolution and lag, the signal current and beam current conditions are given, e.g. as  $I_s/I_b = 20/300$  nA. This means: with a signal current of 20 nA and a beam setting which just allows a signal current of 300 nA.  
N.B. The signal currents are measured with an integrating instrument connected in the signal electrode lead and a uniform illumination of the scanned area. See note 11.
9. The optimum voltage ratio  $V_{g4}/V_{g3}$  to minimize beam landing errors (preferably  $\leq 1$  V) depends on the type of coil unit used. For types AT1116, AT1119 and AT1126 a ratio of 1,6 is recommended. Grid 4 (mesh) should under no circumstances be allowed to operate at a voltage below that of grid 3 as that might damage the target.
10. Measuring conditions: illuminance level 4,54 lx at a colour temperature of 2856K and filters. Schott VG9 and Calflex B1/K1 inserted in the light path. For transmission of the filters, see General Section.



NOTES (continued)

11. The peak signal currents are measured on a waveform oscilloscope and with a uniform illumination on the 16,2 mm Ø target area.  
When measured with an integrating instrument connected in the signal-electrode lead the average signal currents will be smaller:
  - a. By a factor  $\alpha$  ( $\alpha = \frac{100 - \beta}{100}$ ),  $\beta$  being the total blanking time in %; for the CCIR system  $\alpha$  amounts to 0,75.
  - b. By a factor  $\delta$ ,  $\delta$  being the ratio of the active target area (circle with: 16,2 mm Ø) to the area which would correspond with the adjusted scanning amplitude (16,2 mm x 21,6 mm) this ratio amounts to  $\delta = 0,59$ .  
The total ratio of integrated signal current,  $I_s$ , to the peak signal current,  $I_{sp}$ , amount to  $\alpha \times \delta = 0,44$ .
12. As measured with a 50 mm Leitz Summicron lens having a sine response of approximately 85% at 400 TV lines at f:5,6. The published 60% typ. is uncorrected. Tube resolution is higher. Measured with 200 nA signal current and a beam current just sufficient to stabilize a signal current of 400 nA. The horizontal amplitude response can be raised by means of suitable correction circuits, which affect neither the vertical resolution nor the limiting resolution.
13. Measured with a 20 nA signal current and a beam current just sufficient to stabilize a signal current of 300 nA.
14. **Decay lag.** After a minimum of 5 s of illumination of the target. Values and curves shown relating to decay lag represent the residual signal currents in percentages of the original signal current as a function of time, after the illumination has been removed.
15. **Build-up lag.** After 10 s of complete darkness. Values and curves shown relating to build-up lag represent the typical percentages of the ultimate signal obtained as a function of time, after the illumination has been applied.

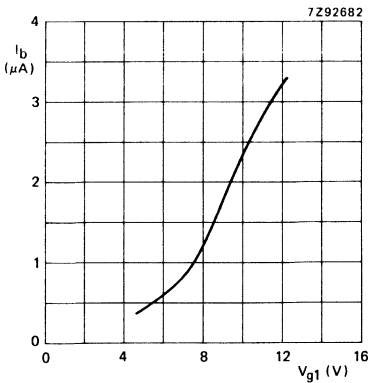

Fig. 3 Average beam current versus grid 1 voltage (see note 11).

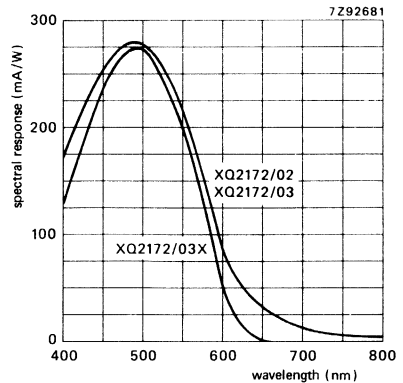

Fig. 4 Typical spectral response curve.

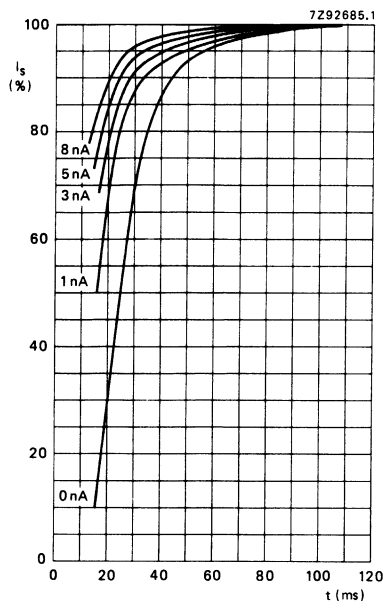

Fig. 5 Build-up lag, see note 15.  
Light-bias induced dark current as parameter.  
 $I_s/I_b = 20/300$  nA.

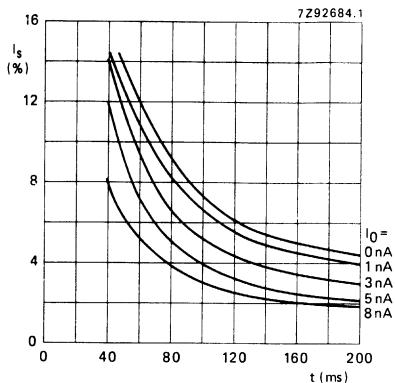

Fig. 6 Decay lag, see note 14.  
 $I_s/I_b = 20/300$  nA.

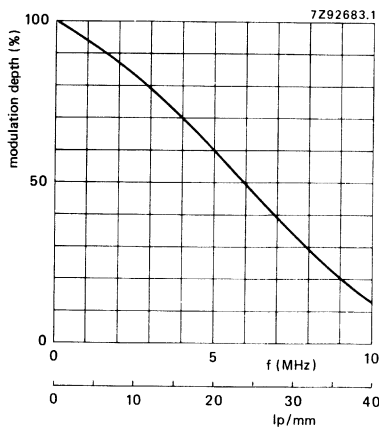

Fig. 7 Typical square-wave transfer characteristic.

## CAMERA TUBES

25,4 mm (1 in) diameter Plumbicon® television camera tubes, with high resolution lead-oxide photo-conductive target, for use in high quality monochrome or colour cameras for broadcast, educational or industrial applications.

The XQ3070 series comprises the following front loading versions:

|         |   |
|---------|---|
| XQ3070  | for use in monochrome cameras   |
| XQ3070L | for use in the luminance channel of colour cameras  |
| XQ3070R | for use in the red channel  |
| XQ3070G | for use in the green channel  |
| XQ3070B | for use in the blue channel   |
| XQ3071  | as XQ3070 series; only difference being the degree of freedom from blemishes on the target (industrial quality tubes) |
| XQ3073R | for use in the red channel; extended red response   |
| XQ3074  | as XQ3073. Industrial grade   |
| XQ3075R | for use in the red channel; extended red response and IR filter   |
| XQ3076  | as XQ3075. Industrial grade   |

These tubes are available in rear loading versions (/02,/05,/12 and /15) only.

Special features are:

- New photoconductive target for increased resolution
- "Diode" electron gun with high beam reserve for dynamic beam control (DBC) to minimize comet-tailing and blooming (notes 1, 2, 3)
- Provision for light bias to reduce lag
- Low output capacitance (LOC) for high signal-to-noise ratio

## QUICK REFERENCE DATA

|  |                                   |
|--|-----------------------------------|
| "Diode" electron gun                   |                                   |
| Diameter                               | 25,4 mm (1 inch)                  |
| Length                                 | approx. 170 mm                    |
| Provided with anti-halation glass disc |                                   |
| Focusing                               | magnetic                          |
| Deflection                             | magnetic                          |
| Useful target area (scanning area)     | 9,6 x 12,8 mm                     |
| Spectral response                      |                                   |
| max. at                                | approx. 500 nm                    |
| cut-off: XQ3070                        | approx. 650 nm                    |
| XQ3073                                 | approx. 850 to 950 nm             |
| XQ3075                                 | approx. 750 nm                    |
| Sensitivity                            |                                   |
| XQ3070, XQ3070L                        | typ. 350 $\mu\text{A}/\text{lm}$  |
| XQ3070R                                | typ. 70 $\mu\text{A}/\text{lmF}$  |
| XQ3070G                                | typ. 145 $\mu\text{A}/\text{lmF}$ |
| XQ3070B                                | typ. 38 $\mu\text{A}/\text{lmF}$  |
| XQ3073R, XQ3075R                       | typ. 100 $\mu\text{A}/\text{lmF}$ |
| Resolution at 400 TV lines (5 MHz)     |                                   |
| XQ3070, XQ3070L                        | typ. 60 %                         |
| XQ3070R                                | typ. 45 %                         |
| XQ3070G                                | typ. 60 %                         |
| XQ3070B                                | typ. 60 %                         |
| XQ3073R, XQ3075R                       | typ. 55 %                         |
| Heater                                 | 6,3 V, 95 mA                      |

® Registered trademark for television camera tubes.

## MECHANICAL VARIANTS

Variants are defined by a suffix as follows:

- XQ . . . /02, R, G, B, L: rear loading versions with provision for internal light bias, target contact ring with 1 target contact, metal sleeve on pumping stem to mount light bias lamp.
- XQ . . . /05, R, G, B, L: as /02, however without provision for light bias lamp.
- XQ . . . /12, R, G, B, L: as /02, however with 2 contacts on the target ring.
- XQ . . . /15, R, G, B, L: as /05, however with 2 contacts on the target ring.

## OPTICAL DATA

notes

|  |               |
|--|---------------|
| Quality rectangle on photoconductive target (aspect ratio 3 : 4)   | 9,6 x 12,8 mm |
| Orientation of image on target:  |               |
| For correct orientation of the image on the target the vertical scan should be essentially parallel to the plane passing through the tube axis and the marker line on the protecting sleeve at the base. |               |
| Faceplate  |               |
| Thickness  | 1,2 ± 0,1 mm  |
| Refractive index   | n = 1,49      |
| Anti-halation glass disc provided with anti reflective coating   |               |
| Thickness  | 5 ± 0,1 mm    |
| Refractive index   | n = 1,52      |
| XQ3075R is provided with infrared reflecting filter  |               |

## ACCESSORIES

|                                    |              |   |
|------------------------------------|--------------|---|
| Socket                             | type 56098   |   |
| Deflection and focusing coil unit: |              |   |
| Black/white                        | type AT1126S |   |
| Colour                             | type AT1126T |   |
| Mask for flare reduction           | type 56028   |   |
| Light bias lamp in holder          | type 56106   | 4 |

## ELECTRICAL DATA

|  |            |                |
|--|------------|----------------|
| Deflection   |            | magnetic       |
| Focusing   |            | magnetic       |
| Heating, indirect by a.c. or d.c.; parallel supply   |            |                |
| Heater voltage   | $V_f$      | 6,3 V ± 5%     |
| Heater current at $V_f = 6,3$ V  | $I_f$ nom. | 95 mA          |
| The heater current and the heater voltage must not exceed r.m.s. values of 150 mA and 9,5 V. For optimum performance (lifetime and registration stability) stabilization of the heater voltage is recommended. |            |                |
| Capacitance  |            |                |
| Signal electrode to all rear loading types /02 and /05   | $C_{as}$   | approx. 2,1 pF |
| rear loading types /12 and /15   | $C_{as}$   | approx. 2,5 pF |
| This capacitance, which is effectively the output impedance, increases when the tube is inserted in the coil unit.   |            |                |

**LIMITING VALUES** (Absolute maximum rating system)

notes

Unless otherwise stated, all voltages are referred to the cathode.

|  |             |      |                  |   |
|--|-------------|------|------------------|---|
| Signal electrode voltage   | $V_{as}$    | max. | 50 V             |   |
| Grid 4 voltage   | $V_{g4}$    | max. | 1100 V           |   |
| Grid 3 voltage   | $V_{g3}$    | max. | 800 V            |   |
| Voltage between grid 4 and grid 3                                  | $V_{g4/g3}$ | max. | 450 V            |   |
| Grid 2 voltage   | $V_{g2}$    | max. | 340 V            |   |
| Grid 1 voltage,  |             |      |                  |   |
| positive   | $V_{g1}$    | max. | 25 V             |   |
| negative   | $-V_{g1}$   | max. | 200 V            |   |
| Grid 1 current   |             |      |                  |   |
| $\approx I_k$ current, without blanking                            | $I_{g1}$    | max. | 5 mA             |   |
| peak to peak with DBC  | $I_{g1p}$   | max. | 8 mA             | 2 |
| Cathode to heater voltage  |             |      |                  |   |
| positive peak  | $V_{kfp}$   | max. | 125 V            |   |
| negative peak  | $-V_{kfp}$  | max. | 50 V             |   |
| Cathode heating time before drawing current                        | $t_h$       | min. | 1 min            |   |
| External resistance between cathode and heater at $V_{kfp} > 10$ V | $R_{kf}$    | min. | 2 k $\Omega$     |   |
| Ambient temperature, storage and operation                         | $T_{amb}$   | max. | 50 $^{\circ}$ C  |   |
|  |             | min. | -30 $^{\circ}$ C |   |
| Faceplate temperature, storage and operation                       | $T$         | max. | 50 $^{\circ}$ C  |   |
|  |             | min. | -30 $^{\circ}$ C |   |
| Faceplate illuminance  | $E$         | max. | 500 lx           | 5 |

**OPERATING CONDITIONS**

For a scanned area of 9,6 x 12,8 mm

|  |             |                       |   |
|--|-------------|-----------------------|---|
| Cathode voltage                          | $V_k$       | 0 V                   | 6 |
| Signal electrode voltage                 | $V_{as}$    | 45 V                  |   |
| Beam current                             | $I_b$       |                       | 7 |
| Grid 4 voltage                           | $V_{g4}$    | 960 V                 |   |
| Grid 3 voltage                           | $V_{g3}$    | 600 V                 |   |
| Grid 2 voltage                           | $V_{g2}$    | 300 V                 |   |
| Grid 1 voltage                           | $V_{g1}$    | V                     | 7 |
| Blanking voltage on grid 1, peak to peak | $V_{g1p-p}$ | 25 V                  |   |
| Faceplate illuminance                    | $E$         | 0 to 10 lx            | 8 |
| Faceplate temperature                    | $T$         | 20 to 45 $^{\circ}$ C | 9 |

**ELECTRON GUN CHARACTERISTICS**

Cut off

Grid 1 voltage for cut-off at  $V_{g2} = 300$  V,

|   |             |               |   |
|---|-------------|---------------|---|
| without blanking                                  | $V_{g1}$    | -10 to 0 V    |   |
| Grid 1 voltage for normal beam setting            | $V_{g1w}$   | $\leq$ 15 V   |   |
| Blanking voltage, peak to peak                    |             |               |   |
| on grid 1   | $V_{g1p-p}$ | 25 V          |   |
| on cathode  | $V_{kp-p}$  | 25 V          |   |
| Grid 1 current at normally required beam currents | $I_{g1}$    | $\leq$ 1,5 mA | 2 |
| Grid 2 current at normally required beam currents | $I_{g2}$    | $\leq$ 0,1 mA | 2 |

# XQ3070 SERIES

## PERFORMANCE

|   |       |               |                      |       |
|---|-------|---------------|----------------------|-------|
| Dark current  | $I_d$ | $\leq$        | 2 nA                 | notes |
| Sensitivity at colour temperature of illuminance = 2856 K   |       |               |                      | 10    |
| XQ3070, L   | min.  | 300           | typ. 350 $\mu$ A/lm  |       |
| XQ3070R   | min.  | 63            | typ. 70 $\mu$ A/lmF  |       |
| XQ3070G   | min.  | 130           | typ. 145 $\mu$ A/lmF |       |
| XQ3070B   | min.  | 35            | typ. 38 $\mu$ A/lmF  |       |
| XQ3073R, XQ3075R  | min.  | 80            | typ. 100 $\mu$ A/lmF |       |
| Gamma of transfer characteristic  |       |               | 0,95 $\pm$ 0,05      |       |
| Spectral response, max. at  |       |               | 500 nm               |       |
| Spectral response, cut-off at   |       |               | 650 to 950 nm        |       |
| Spectral response curves  |       | see Figs 1, 2 |                      |       |
| Resolution  |       |               |                      | 11    |
| Modulation depth, i.e. uncompensated amplitude response at 400 TV lines at the centre of the picture. |       |               |                      |       |

|                                  | XQ3070<br>XQ3070L<br>XQ3070G | XQ3070R | XQ3070B | XQ3073R<br>XQ3075R | 7, 11 |
|----------------------------------|------------------------------|---------|---------|--------------------|-------|
| Highlight signal current $I_s$   | 200                          | 100     | 100     | 100                | nA    |
| Beam current $I_b$               | 400                          | 200     | 200     | 200                | nA    |
| Modulation depth at 400 TV lines |                              |         |         |                    |       |
| typ.                             | 60                           | 45      | 60      | 55                 | %     |
| min.                             | 55                           | 40      | 55      | 50                 | %     |

Modulation transfer characteristics: see Figs 3 and 4

Lag (typical values, with light bias of 3 nA)

12, 13

Light source with a colour temperature of 2856 K. Appropriate filter inserted in the light path for the chrominance tubes R, G and B

## LOW KEY CONDITIONS

|                  | build-up lag          |        | decay lag             |        |
|------------------|-----------------------|--------|-----------------------|--------|
|                  | $I_s/I_b = 20/300$ nA |        | $I_s/I_b = 20/300$ nA |        |
|                  | 60 ms                 | 200 ms | 60 ms                 | 200 ms |
| XQ3070, L        | 95%                   | ~ 100% | 9%                    | 2,5%   |
| XQ3070G          | 95%                   | ~ 100% | 9%                    | 2,5%   |
| XQ3070R          | 95%                   | ~ 100% | 9%                    | 2,5%   |
| XQ3070B          | 90%                   | ~ 100% | 12%                   | 4%     |
| XQ3073R, XQ3075R | 90%                   | ~ 100% | 11%                   | 3%     |

Shading of light bias induced dark current

12,5%

14

Highlight handling capability with DBC

15

**MECHANICAL DATA**

Rear loading tubes XQ3070/02 and XQ3070/12

Mounting position: any

Mass:  $\approx 70$  g

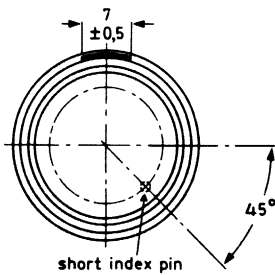
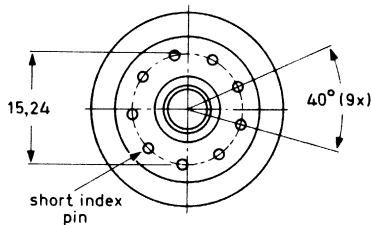
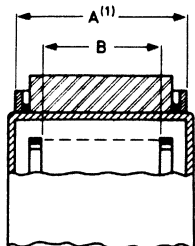
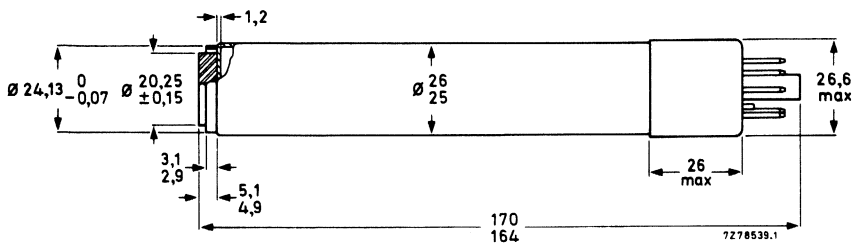

FRONT VIEW 7283927 XQ.../02

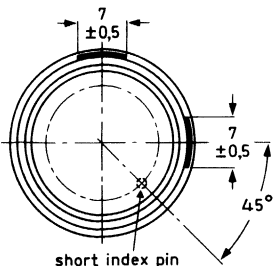
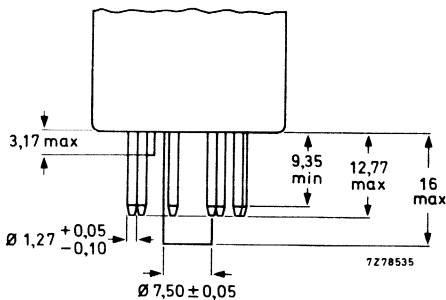

FRONT VIEW 7261633.3 XQ.../12

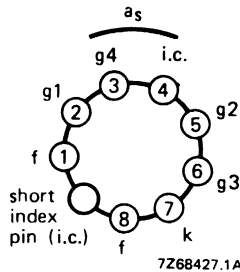

- (1) The distance between the geometrical centres of diameter A of the reference ring and diameter B of the mesh electrode ring is  $< 100 \mu\text{m}$ .

# XQ3070 SERIES

Rear loading tubes XQ3070/05 and XQ3070/15

Mounting position: any

Mass:  $\approx 70$  g

Base: IEC 67-I-33a (JEDEC E8-11)

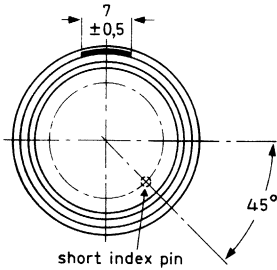
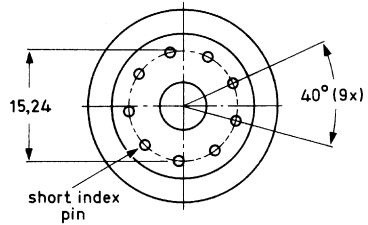
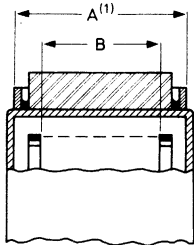
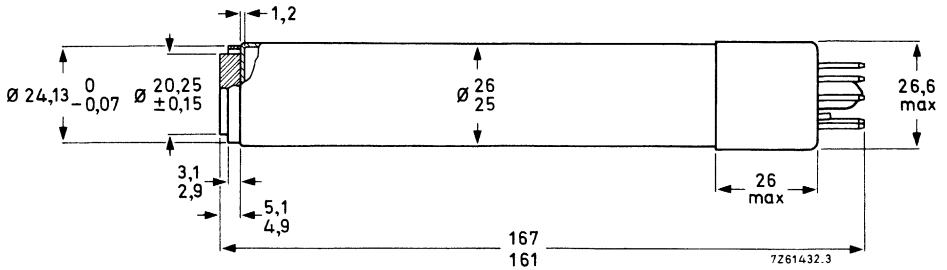

FRONT VIEW 7261432.7  
XQ.../05

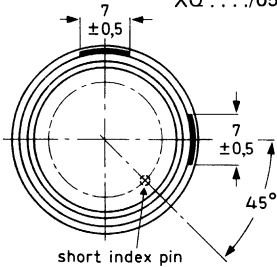
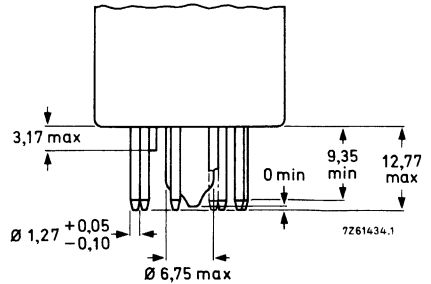

FRONT VIEW 7261433.3  
XQ.../15

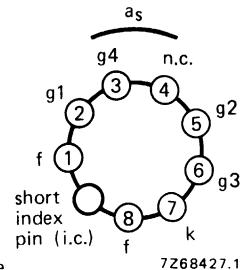

(1) The distance between the geometrical centres of diameter A of the reference ring and diameter B of the mesh electrode ring is  $< 100 \mu\text{m}$ .



**NOTES, see also General Section**

1. "Diode" electron gun is a triode gun operating in a diode mode, providing a very high beam reserve.  
**N.B.**  
Avoid continuous operation at high beam currents since this will shorten tube life. Full advantage of the high beam reserve to reduce comet-tailing and blooming can be made with DBC circuitry which, during highlights, feeds positive-going pulses derived from the video signal to grid 1, to increase the beam current momentarily.
2. The "diode" gun operates with a positive ( $\leq 15$  V) grid 1 voltage (adjusted for correct beam settings, see note 7), hence draws some grid 1 current:  
without DBC:  $\leq 1,5$  mA (peak) with blanking  
with DBC:  $\leq 8$  mA (peak) with blanking, measured with oscilloscope.  
The DBC circuitry should, in the case of highlights, supply positive-going pulses of 7 V above  $V_{g1w}$  (see note 7) and up to 8 mA peak to grid 1.  
**N.B.**  
Applying higher pulses than 7 V is not recommended since this will shorten tube life, impair resolution and may introduce oscillations.
3. The XQ3070 tubes closely resemble mechanically the tubes of the XQ1080/XQ1500 series. Since, however, the "Diode" electron gun draws some grid 1 current (see note 2), cameras designed around XQ1080/XQ1500 tubes will require some modification.
4. For adjustable light bias in versions /02 and /12. The light bias lamp assembly as supplied with these tubes, type 56106, fits in the metal tube cemented to the pumping stem of the tube. The tube and the light bias lamp assembly will fit properly in the socket, type 56098. The wires should be connected to a source, capable of supplying max. 110 mA at 5 V.  
The desired amount of light bias can be obtained by adjusting the current through the filament of the lamp. For black/white operation a light bias corresponding to 2 to 3 nA extra dark current is usually adequate for excellent speed of response. In a colour camera the speeds of response of the tubes can be balanced by adjusting the amount of light bias per tube. A typical setting in a 3-tube colour camera could be 3 nA (R), 2 nA (G), and 6 nA (B). Infrared light with a wavelength  $> 600$  nm in the light bias should be avoided.
5. For short intervals. During storage the tube face shall be covered with the plastic hood provided; when the camera is idle the lens shall be capped, in stand-by also the beam will be cut-off.
6. The operating conditions and performance data quoted relate to operation of the tube in coil unit AT1126. See relevant data of deflection/focusing assemblies.
7. The beam current  $I_b$ , as obtained by adjusting the control grid (grid 1) voltage is set for 1 stop over peak white and is 200 nA for R and B tubes, 400 nA for black/white and G tubes.  $I_b$  is not the total current available in the scanning beam, but is defined as the maximum amount of signal current,  $I_s$ , that can be obtained with this beam.  
In the performance figures e.g. for lag, the signal current and beam current conditions are given as  $I_s/I_b = 20/300$  nA. This means: with a signal current of 20 nA and a beam setting which just allows a signal current of 300 nA.
8. Typical faceplate illumination level for the XQ3070 and XQ3070L to produce 200 nA signal current will be approx. 4,6 lx. The signal currents stated for the colour tubes R, G and B will be obtained with an incident white light level (2856 K) on the filter of approx. 11 lx. These figures are based on the filters described in note 10. For filter BG12, however, a thickness of 1 mm is chosen.
9. The tube can withstand short excursions up to 70 °C without damage or irreversible degradation in performance.

10. Measuring conditions: illuminance level 4,54 lx at a colour temperature of 2856 K and the appropriate filter inserted in the light path. Filters used are:

|                  |             |       |           |      |
|------------------|-------------|-------|-----------|------|
| XQ3070R, XQ3075R | Schott      | OG570 | thickness | 3 mm |
| XQ3070G          | Schott      | VG9   | thickness | 1 mm |
| XQ3070B          | Schott      | BG12  | thickness | 3 mm |
| XQ3073R          | Schott      | OG570 | thickness | 3 mm |
|                  | and Calflex | B1/K1 |           |      |

For transmission curves see General Section.

11. As measured with a 50 mm Leitz Summicron lens having a sine response of approximately 85% at 20,6 lp/mm (400 TV lines at 9,6 mm picture height) at  $f : 5,6$  and the appropriate filter inserted in the light path. The amplitude response can be raised by means of suitable correction circuits.
12. Adjusted for sum of dark current, leakage current and light bias current of 3 nA.
13. **Build-up lag**

After 10 s of darkness. The figures are typical percentages of the ultimate signal current obtained 60 ms and 200 ms, respectively, after the introduction of the illuminance.

**Decay lag**

After the target has been illuminated for at least 5 s. The figures represent typical signals in percentages of the original signal current 60 ms and 200 ms, respectively, after removal of the illuminance.

14. Deviation of the level of any of the four corners, i.e. 10% inwards in L and V direction, from the level in the picture centre. The observed shading is composed of slight parabolic and sawtooth components in both line and frame direction which can be sufficiently compensated by suitable black shading compensation circuitry.
15. a. With DBC applied (see note 2) the tube will properly handle highlights with a diameter of 10% of the picture height and with a brightness corresponding to 16 times peak signal white,  $I_{sp}$ .
- b. The maximum peak signal currents in the case of highlights will be 2,5  $\mu$ A. Video preamplifiers should be designed to accommodate these.

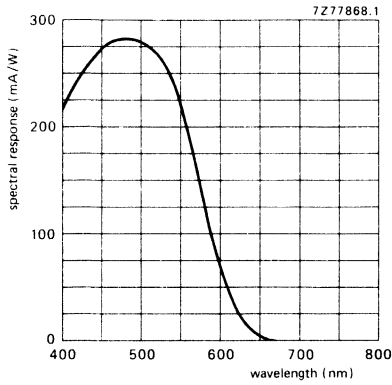

Fig. 1 Typical spectral response XQ3070, R, G, B.

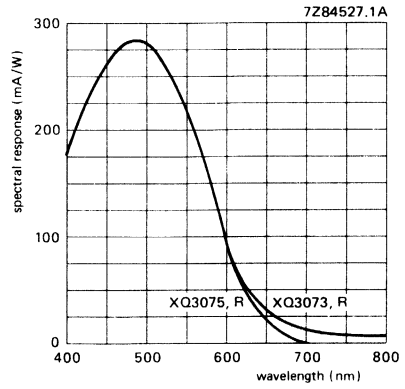

Fig. 2 Typical spectral response XQ3073R, XQ3075R.

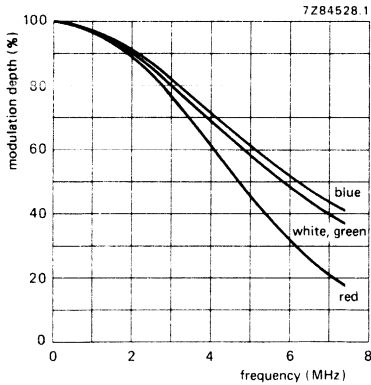

Fig. 3 Typical square-wave response curves XQ3070.

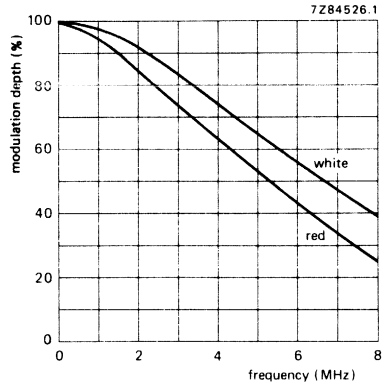

Fig. 4 Typical square-wave response curves XQ3073/XQ3075.



**18 mm dia. PLUMBICON TUBES**



## CAMERA TUBES

18 mm (2/3 in) diameter Plumbicon® television camera tubes, with standard resolution lead-oxide photoconductive target, for use in high quality monochrome or colour cameras for broadcast, educational or industrial applications.

The XQ1427 series comprises the following versions:

|         |  |
|---------|--|
| XQ1427  | for use in monochrome cameras  |
| XQ1427R | for use in the red channel   |
| XQ1427G | for use in the green channel   |
| XQ1427B | for use in the blue channel  |
| XQ1428  | as XQ1427 series; only difference being the degree of freedom from blemishes on the target (industrial quality tubes). |

Special feature:

- Mechanically interchangeable with 2/3 inch diameter Vidicon tubes with separate mesh. See note 1.

## QUICK REFERENCE DATA

|  |                                   |
|--|-----------------------------------|
| Separate mesh                          |                                   |
| Diameter                               | 17,8 mm (2/3 inch)                |
| Length                                 | approx. 108 mm                    |
| Provided with anti-halation glass disc |                                   |
| Focusing                               | magnetic                          |
| Deflection                             | magnetic                          |
| Useful target area (scanning area)     | 6,6 x 8,8 mm                      |
| Spectral response                      |                                   |
| max. at                                | approx. 500 nm                    |
| cut-off: XQ1427R                       | approx. 850 nm                    |
| XQ1427, XQ1427G                        | approx. 650 to 850 nm             |
| XQ1427B                                | approx. 650 nm                    |
| Sensitivity                            |                                   |
| XQ1427                                 | typ. 365 $\mu\text{A}/\text{lm}$  |
| XQ1427R                                | typ. 100 $\mu\text{A}/\text{lmF}$ |
| XQ1427G                                | typ. 135 $\mu\text{A}/\text{lmF}$ |
| XQ1427B                                | typ. 38 $\mu\text{A}/\text{lmF}$  |
| Resolution at 320 TV lines (4 MHz)     |                                   |
| XQ1427                                 | typ. 60 %                         |
| XQ1427R                                | typ. 52 %                         |
| XQ1427G                                | typ. 60 %                         |
| XQ1427B                                | typ. 65 %                         |
| Heater                                 | 6,3 V, 95 mA                      |

## OPTICAL DATA

notes

|   |              |
|---|--------------|
| Quality rectangle on photoconductive target (aspect ratio 3 : 4)  | 6,6 x 8,8 mm |
| Orientation of image on target:<br>For correct orientation of the image on the target the vertical scan should be essentially parallel to the plane passing through the tube axis and the gap between pins 1 and 7. |              |
| Faceplate   |              |
| Thickness   | 2,3 ± 0,1 mm |
| Refractive index  | n = 1,49     |
| Anti-halation glass disc provided with anti reflective coating  |              |
| Thickness   | 3,7 ± 0,1 mm |
| Refractive index  | n = 1,52     |

## ACCESSORIES

|                                    |                     |                      |
|------------------------------------|---------------------|----------------------|
| Socket                             | type 56049          |                      |
| Deflection and focusing coil unit: | <u>rear loading</u> | <u>front loading</u> |
| Black/white                        | type AT1109S        | AT1106S              |
| Colour                             | type AT1109T        | AT1106T              |
| Mask for flare reduction           | type 56033          |                      |

## ELECTRICAL DATA

|  |            |             |
|--|------------|-------------|
| Deflection   |            | magnetic    |
| Focusing   |            | magnetic    |
| Heating, indirect by a.c. or d.c.; parallel supply   |            |             |
| Heater voltage   | $V_f$      | 6,3 V ± 5%  |
| Heater current at $V_f = 6,3$ V  | $I_f$ nom. | 95 mA       |
| The heater voltage must not exceed an r.m.s. value of 9 V. For optimum performance (lifetime and registration stability) stabilization of the heater voltage is recommended. |            |             |
| Capacitance  |            |             |
| Signal electrode to all  | $C_{as}$   | 1,5 to 3 pF |
| This capacitance, which is effectively the output impedance, increases when the tube is inserted in the coil unit.   |            |             |



**LIMITING VALUES** (Absolute maximum rating system)

notes

Unless otherwise stated, all voltages are referred to the cathode.

|   |             |      |              |   |
|---|-------------|------|--------------|---|
| Signal electrode voltage  | $V_{as}$    | max. | 50 V         | 1 |
| Grid 4 voltage  | $V_{g4}$    | max. | 1000 V       |   |
| Grid 3 voltage  | $V_{g3}$    | max. | 750 V        |   |
| Voltage between grid 4 and grid 3                                   | $V_{g4/g3}$ | max. | 400 V        |   |
| Grid 2 voltage  | $V_{g2}$    | max. | 350 V        |   |
| Grid 1 voltage,   |             |      |              |   |
| positive  | $V_{g1}$    | max. | 0 V          |   |
| negative  | $-V_{g1}$   | max. | 200 V        |   |
| Cathode heating time before drawing                                 |             |      |              |   |
| cathode current   | $t_h$       | min. | 1 min        |   |
| Cathode to heater voltage   |             |      |              |   |
| positive peak   | $V_{kfp}$   | max. | 125 V        |   |
| negative peak   | $-V_{kfp}$  | max. | 50 V         |   |
| External resistance between cathode and heater at $-V_{kfp} > 10$ V | $R_{kf}$    | min. | 2 k $\Omega$ |   |
| Ambient temperature, storage and operation                          | $T_{amb}$   | max. | 50 °C        |   |
|   |             | min. | -30 °C       |   |
| Faceplate temperature, storage and operation                        | $T$         | max. | 50 °C        | 2 |
|   |             | min. | -30 °C       |   |
| Faceplate illuminance   | $E$         | max. | 500 lx       | 3 |

**OPERATING CONDITIONS**

For a scanned area of 6,6 x 8,8 mm.

|  |             |                                      |             |
|--|-------------|--------------------------------------|-------------|
| Cathode voltage                          | $V_k$       | 0 V                                  | 4           |
| Signal electrode voltage                 | $V_{as}$    | 45 V                                 |             |
| Beam current                             | $I_b$       |                                      | 5           |
|  |             | low voltage mode   high voltage mode |             |
| Grid 4 voltage                           | $V_{g4}$    | 500                                  | 750 V       |
| Grid 3 voltage                           | $V_{g3}$    | 285                                  | 430 V       |
| Grid 2 voltage                           | $V_{g2}$    | 300                                  | 300 V       |
| Grid 1 voltage                           | $V_{g1}$    |                                      |             |
| Blanking voltage on grid 2, peak to peak | $V_{g1p-p}$ |                                      | 50 V        |
| Faceplate illuminance                    |             |                                      | 0 to 10 lx  |
| Faceplate temperature                    |             |                                      | 20 to 45 °C |

**ELECTRON GUN CHARACTERISTICS**

Cut off

Grid 1 voltage for cut-off at  $V_{g2} = 300$  V, without blanking

$V_{g1}$  -30 to -80 V

Grid 1 voltage for normal beam setting

$V_{g1w}$  -30 to -10 V

Blanking voltage, peak to peak

  on grid 1

$V_{g1p-p}$  50  $\pm$  10 V

  on cathode

$V_{kp-p}$  25 V

Grid 2 current at normally required beam currents

$I_{g2}$   $\leq$  0,5 mA

# XQ1427 SERIES

## PERFORMANCE

|  |            |        |                              |       |
|--|------------|--------|------------------------------|-------|
| Dark current   | $I_d$      | $\leq$ | 1,5 nA                       | notes |
| Sensitivity at colour temperature of illuminance = 2856 K  | K          |        |                              | 7     |
| XQ1427   | min. 330   | typ.   | 365 $\mu\text{A}/\text{lm}$  |       |
| XQ1427R  | min. 75    | typ.   | 100 $\mu\text{A}/\text{lmF}$ |       |
| XQ1427G  | min. 110   | typ.   | 135 $\mu\text{A}/\text{lmF}$ |       |
| XQ1427B  | min. 35    | typ.   | 38 $\mu\text{A}/\text{lmF}$  |       |
| Gamma of transfer characteristics  |            |        | $0,95 \pm 0,05$              |       |
| Spectral response, max. at   | approx.    |        | 500 nm                       | 9     |
| Spectral response, cut-off at  | approx.    |        | 650 to 850 nm                |       |
| Spectral response curves   | see Fig. 1 |        |                              |       |
| Resolution   |            |        |                              |       |
| Modulation depth, i.e. uncompensated amplitude response at 320 TV lines at the centre of the picture (4 MHz) |            |        |                              | 10    |

|  | XQ1427 | XQ1427R | XQ1427G | XQ1427B |    |
|--|--------|---------|---------|---------|----|
| Highlight signal current $I_s$           | 150    | 75      | 150     | 75      | nA |
| Beam current $I_b$                       | 300    | 150     | 300     | 150     | nA |
| Modulation depth at 320 TV lines (4 MHz) |        |         |         |         |    |
| high voltage mode, typ.                  | 60     | 52      | 60      | 65      | %  |
| min.                                     | 55     | 47      | 55      | 60      | %  |
| low voltage mode, typ.                   | 55     | 47      | 55      | 60      | %  |
| min.                                     | 50     | 40      | 50      | 55      | %  |

Modulation transfer characteristics: see Figs 2 and 3

Lag (typical values, no light bias applied)

11,12

Light source with a colour temperature of 2856 K. Appropriate filter inserted in the light path for the chrominance tubes R, G and B.

## LOW KEY CONDITIONS

|                 | build-up lag          |               | decay lag             |        |
|-----------------|-----------------------|---------------|-----------------------|--------|
|                 | $I_s/I_b = 20/300$ nA |               | $I_s/I_b = 20/300$ nA |        |
|                 | 60 ms                 | 200 ms        | 60 ms                 | 200 ms |
| XQ1427, XQ1427G | 90                    | $\approx 100$ | 9                     | 3 %    |
| XQ1427R         | 90                    | $\approx 100$ | 9,5                   | 4 %    |
| XQ1427B         | 90                    | $\approx 100$ | 9,5                   | 4 %    |

MECHANICAL DATA

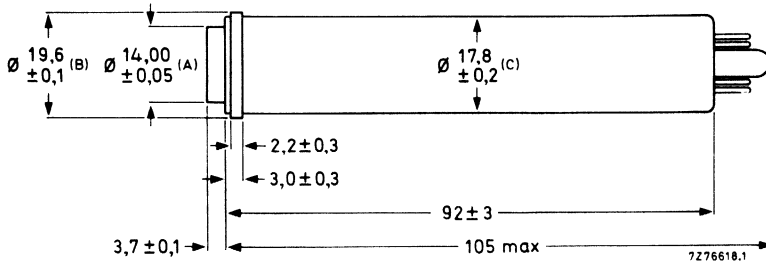

The distance between the geometrical centres of diameters A (anti-halation disc), B (signal-electrode ring), and the geometrical centre of diameter C (tube envelope) is  $\leq 200 \mu\text{m}$ .

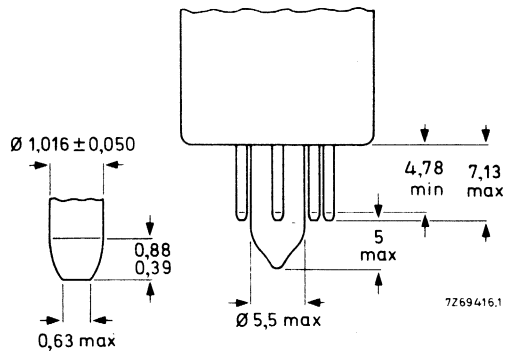
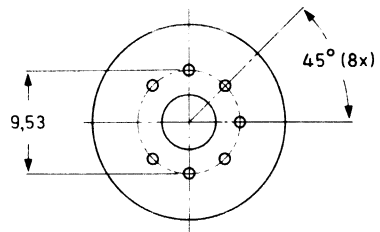
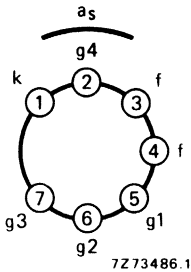

Mounting position: any

Mass:  $\approx 23 \text{ g}$

Base: EIA E7-91

**NOTES**, see also General Section

1. Plumbicon tubes do not permit automatic sensitivity control by means of regulation of the signal electrode voltage. Adequate control is therefore to be achieved by other means (iris control and neutral density filters).

N.B. When the tube is to be used in a camera originally designed for vidicon tubes, the automatic sensitivity control circuitry should be made inoperative and the signal electrode voltage be set to 45 V, in order to prevent damage or destruction of the target.

2. The tube can withstand short excursions up to 70 °C without damage or irreversible degradation in performance.
3. For short intervals. During storage the tube face shall be covered with the plastic hood provided; when the camera is idle the lens shall be capped, in stand-by also the beam will be cut-off.
4. The operating conditions and performance data quoted relate to operation of the tube in coil unit AT1109. See relevant data of deflection/focusing assemblies.
5. The beam current  $I_b$ , as obtained by adjusting the control grid (grid 1) voltage is set to 150 nA for R and B tubes, 300 nA for black and white and G tubes.  $I_b$  is not the actual current available in the scanning beam, but is defined as the maximum amount of signal current,  $I_s$ , that can be obtained with this beam.

In the performance figures for lag, the signal current and beam current conditions are given, e.g. as  $I_s/I_b = 20/300$  nA. This means: with a signal current of 20 nA and a beam setting which just allows a signal current of 300 nA.

The signal currents are measured with an integrating instrument connected in the signal electrode lead and a uniform illumination of the scanned area. The peak signal currents as measured on a waveform oscilloscope will be a factor  $\alpha$  larger.  $\alpha = 100/(100 - \beta)$ ,  $\beta$  being the total blanking time in %; for the CCIR system  $\alpha = 1,3$ .

6. a. The optimum voltage ratio  $V_{g4}/V_{g3}$  to minimize beam landing errors (preferably  $< 1$ ) depends on the type of coil unit used. In the coil AT1109 a ratio of 1,75 is required. Under no circumstances should grid 4 (mesh) be allowed to operate at a voltage below that of grid 3 as this may damage the target.  
 b. An attractive gain in resolving power is obtained when the tubes are operated with higher grid 3 and grid 4 potentialials.

N.B. Since such operation requires increased focusing and deflection power, special measures (air cooling, heatsinks) have to be taken in the camera design to prevent faceplate temperatures exceeding the limiting value of 50 °C, which would otherwise affect tube performance and life. See also General Operational notes.

7. Typical faceplate illumination level for the XQ1427 to produce 150 nA signal current will be approx. 7 lx. The signal currents stated for the colour tubes R, G and B will be obtained with an incident white light level (2856 K) on the filter of approx. 19 lx. These figures are based on the filters described in note 8. For filter BG12, however, a thickness of 1 mm is chosen.
8. Measuring conditions: illuminance level 4,54 lx at a colour temperature of 2856 K and the appropriate filter inserted in the light path.

Filters used are:

|         |             |       |           |      |
|---------|-------------|-------|-----------|------|
| XQ1427G | Schott      | VG9   | thickness | 1 mm |
| XQ1427B | Schott      | BG12  | thickness | 3 mm |
| XQ1427R | Schott      | OG570 | thickness | 3 mm |
|         | and Calflex | B1/K1 |           |      |

For transmission curves see General Section.

9. For true tonal rendition in black/white cameras and for true colorimetry in colour cameras an integral filter to eliminate response to near infrared radiation should be incorporated in the optical system, together with an integral B1/K1 filter or equivalent.

10. As measured with a 50 mm Leitz Summicron lens having a sine response of approximately 80% at 400 TV lines at  $f : 5,6$  and the appropriate filter inserted in the light path. The horizontal amplitude response can be raised by means of suitable correction circuits, which affect neither the vertical resolution nor the limiting resolution.
11. **Build-up lag**  
After 10 s of darkness. The figures are typical percentages of the ultimate signal current obtained 60 ms and 200 ms, respectively, after the introduction of the illuminance.
- Decay lag**  
After the target has been illuminated for at least 5 s. The figures represent typical signals in percentages of the original signal current 60 ms and 200 ms, respectively, after removal of the illuminance.
12. A reduction of lag, especially under low key conditions is obtained when light bias (up to 5 nA peak) is applied via the optical system. Infrared light with a wavelength  $> 600$  nm in the light bias should be avoided.

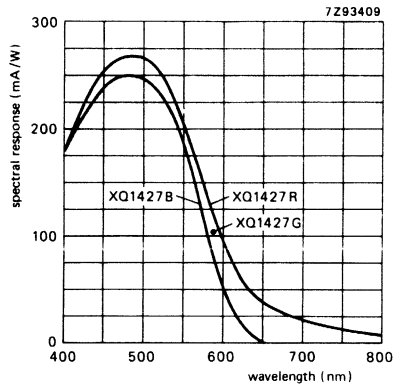

Fig. 1 Typical spectral response.

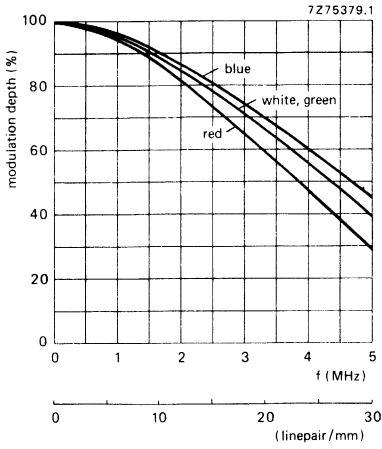

Fig. 2 Typical square wave response curves (low voltage mode).

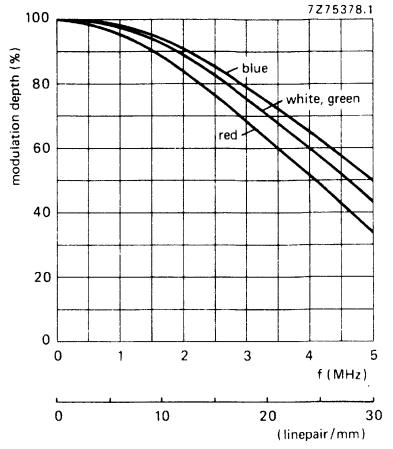

Fig. 3 Typical square wave response curves (high voltage mode).

## CAMERA TUBES

18 mm (2/3 in) diameter Plumbicon® television camera tubes, with high resolution lead-oxide photoconductive target, for use in high quality monochrome or colour cameras for broadcast, educational or industrial applications.

The XQ2427 series comprises the following versions:

- XQ2427 for use in monochrome cameras
- XQ2427R for use in the red channel
- XQ2427G for use in the green channel
- XQ2427B for use in the blue channel
- XQ2428 as XQ2427 series; only difference being the degree of freedom from blemishes on the target (industrial quality tubes).

Special features are:

- New photoconductive target for increased resolution
- "Diode" electron gun with high beam reserve for dynamic beam control (DBC) to minimize comet-tailing and blooming, see notes 1 and 2.

## QUICK REFERENCE DATA

|  |                                   |
|--|-----------------------------------|
| "Diode" electron gun                   |                                   |
| Diameter                               | 17,8 mm (2/3 inch)                |
| Length                                 | approx. 108 mm                    |
| Provided with anti-halation glass disc |                                   |
| Focusing                               | magnetic                          |
| Deflection                             | magnetic                          |
| Useful target area (scanning area)     | 6,6 x 8,8 mm                      |
| Spectral response                      |                                   |
| max. at                                | approx. 500 nm                    |
| cut-off: XQ2427R                       | approx. 850 nm                    |
| XQ2427, XQ2427G                        | approx. 650 to 850 nm             |
| XQ2427B                                | approx. 650 nm                    |
| Sensitivity                            |                                   |
| XQ2427                                 | typ. 320 $\mu\text{A}/\text{Im}$  |
| XQ2427R                                | typ. 95 $\mu\text{A}/\text{ImF}$  |
| XQ2427G                                | typ. 125 $\mu\text{A}/\text{ImF}$ |
| XQ2427B                                | typ. 38 $\mu\text{A}/\text{ImF}$  |
| Resolution at 400 TV lines (5 MHz)     |                                   |
| XQ2427                                 | typ. 50 %                         |
| XQ2427R                                | typ. 45 %                         |
| XQ2427G                                | typ. 50 %                         |
| XQ2427B                                | typ. 55 %                         |
| Heater                                 | 6,3 V, 95 mA                      |

## OPTICAL DATA

|   |              |
|---|--------------|
| Quality rectangle on photoconductive target (aspect ratio 3 : 4)  | 6,6 x 8,8 mm |
| Orientation of image on target:<br>For correct orientation of the image on the target the vertical scan should be essentially parallel to the plane passing through the tube axis and the gap between pins 1 and 7. |              |
| Faceplate   |              |
| Thickness   | 2,3 ± 0,1 mm |
| Refractive index  | n = 1,49     |
| Anti-halation glass disc provided with anti-reflective coating  |              |
| Thickness   | 2,5 ± 0,1 mm |
| Refractive index  | n = 1,52     |

## ACCESSORIES

|                                    |                     |                      |
|------------------------------------|---------------------|----------------------|
| Socket                             | type 56049          |                      |
| Deflection and focusing coil unit: | <u>rear loading</u> | <u>front loading</u> |
| Black/white                        | type AT1109S        | AT1106S              |
| Colour                             | type AT1109T        | AT1106T              |
| Mask for flare reduction           | type 56033          |                      |

## ELECTRICAL DATA

|  |            |             |
|--|------------|-------------|
| Deflection   |            | magnetic    |
| Focusing   |            | magnetic    |
| Heating, indirect by a.c. or d.c.; parallel supply   |            |             |
| Heater voltage   | $V_f$      | 6,3 V ± 5%  |
| Heater current at $V_f = 6,3$ V  | $I_f$ nom. | 95 mA       |
| The heater voltage must not exceed an r.m.s. value of 9 V. For optimum performance (lifetime and registration stability) stabilization of the heater voltage is recommended. |            |             |
| Capacitance  |            |             |
| Signal electrode to all  | $C_{as}$   | 1,5 to 3 pF |
| This capacitance, which is effectively the output impedance, increases when the tube is inserted in the coil unit.   |            |             |



**LIMITING VALUES** (Absolute maximum rating system)

notes

Unless otherwise stated, all voltages are referred to the cathode.

|  |             |      |              |   |
|--|-------------|------|--------------|---|
| Signal electrode voltage                     | $V_{as}$    | max. | 50 V         | 3 |
| Grid 4 voltage                               | $V_{g4}$    | max. | 1000 V       |   |
| Grid 3 voltage                               | $V_{g3}$    | max. | 750 V        |   |
| Voltage between grid 4 and grid 3            | $V_{g4/g3}$ | max. | 400 V        |   |
| Grid 2 voltage                               | $V_{g2}$    | max. | 350 V        |   |
| Grid 1 voltage,                              |             |      |              |   |
| positive                                     | $V_{g1}$    | max. | 25 V         |   |
| negative                                     | $-V_{g1}$   | max. | 200 V        |   |
| Grid 1 current ( $\approx I_k$ )             | $I_{g1}$    | max. | 5 mA         | 4 |
| Grid 1 current (peak with DBC)               | $I_{g1p}$   | max. | 8 mA         |   |
| Cathode heating time before drawing          |             |      |              |   |
| cathode current                              | $t_h$       | min. | 1 min        |   |
| Cathode to heater voltage                    |             |      |              |   |
| positive peak                                | $V_{kfp}$   | max. | 125 V        |   |
| negative peak                                | $-V_{kfp}$  | max. | 50 V         |   |
| External resistance between                  |             |      |              |   |
| cathode and heater at $V_{kfp} > 10$ V       | $R_{kf}$    | min. | 2 k $\Omega$ |   |
| Ambient temperature, storage and operation   | $T_{amb}$   | max. | 50 °C        |   |
|  |             | min. | -30 °C       |   |
| Faceplate temperature, storage and operation | $T$         | max. | 50 °C        | 5 |
|  |             | min. | -30 °C       |   |
| Faceplate illuminance                        | $E$         | max. | 500 lx       | 6 |

**OPERATING CONDITIONS**

7

For a scanned area of 6,6 x 8,8 mm.

|  |             |                  |                   |
|--|-------------|------------------|-------------------|
| Cathode voltage                          | $V_k$       | 0 V              |                   |
| Signal electrode voltage                 | $V_{as}$    | 45 V             |                   |
| Beam current                             | $I_b$       |                  | 8                 |
|  |             | low voltage mode | high voltage mode |
| Grid 4 voltage                           | $V_{g4}$    | 500              | 750 V             |
| Grid 4 voltage                           | $V_{g3}$    | 285              | 430 V             |
| Grid 2 voltage                           | $V_{g2}$    | 300              | 300 V             |
| Grid 1 voltage                           | $V_{g1}$    |                  |                   |
| Blanking voltage on grid 2, peak to peak | $V_{g1p-p}$ |                  | 25 V              |
| Faceplate illuminance                    |             |                  | 0 to 10 lx        |
| Faceplate temperature                    |             |                  | 20 to 45 °C       |

**ELECTRON GUN CHARACTERISTICS**

Cut off

|   |             |        |            |   |
|---|-------------|--------|------------|---|
| Grid 1 voltage for cut-off at $V_{g2} = 300$ V, |             |        |            |   |
| without blanking                                | $V_{g1}$    |        | -10 to 0 V |   |
| Grid 1 voltage for normal beam setting          | $V_{g1w}$   | $\leq$ | 15 V       | 8 |
| Blanking voltage, peak to peak                  |             |        |            |   |
| on grid 1                                       | $V_{g1p-p}$ |        | 25 V       |   |
| on cathode                                      | $V_{kp-p}$  |        | 25 V       |   |
| Grid 1 current at normally required             |             |        |            |   |
| beam currents                                   | $I_{g1}$    | $\leq$ | 1,5 mA     |   |
| Grid 2 current at normally required             |             |        |            |   |
| beam currents                                   | $I_{g2}$    | $\leq$ | 0,1 mA     |   |

## PERFORMANCE

|  |            |        |                 |       |
|--|------------|--------|-----------------|-------|
| Dark current   | $I_d$      | $\leq$ | 1,0 nA          | notes |
| Sensitivity at colour temperature of illuminance = 2856 K  | K          |        |                 | 11    |
| XQ2427   | min. 275   | typ.   | 320 $\mu A/lm$  |       |
| XQ2427R  | min. 80    | typ.   | 95 $\mu A/lmF$  |       |
| XQ2427G  | min. 95    | typ.   | 125 $\mu A/lmF$ |       |
| XQ2427B  | min. 35    | typ.   | 38 $\mu A/lmF$  |       |
| Gamma of transfer characteristics  |            |        | $0,95 \pm 0,05$ |       |
| Spectral response, max. at   | approx.    |        | 500 nm          | 12    |
| Spectral response, cut-off at  | approx.    |        | 650 to 850 nm   |       |
| Spectral response curves   | see Fig. 1 |        |                 |       |
| Resolution   |            |        |                 | 13    |
| Modulation depth, i.e. uncompensated amplitude response at 400 TV lines at the centre of the picture (5 MHz) |            |        |                 |       |

|  | XQ2427 | XQ2427R | XQ2427G | XQ2427B |    |
|--|--------|---------|---------|---------|----|
| Highlight signal current $I_s$           | 200    | 150     | 200     | 150     | nA |
| Beam current $I_b$                       | 400    | 300     | 400     | 300     | nA |
| Modulation depth at 400 TV lines (5 MHz) |        |         |         |         |    |
| high voltage mode, typ.                  | 50     | 45      | 50      | 55      | %  |
| min.                                     | 45     | 40      | 45      | 50      | %  |
| low voltage mode, typ.                   | 45     | 40      | 45      | 50      | %  |
| min.                                     | 40     | 35      | 40      | 45      | %  |

Modulation transfer characteristics: see Fig. 2

Lag (typical values, without light bias)

14,15

Light source with a colour temperature of 2856 K. Appropriate filter inserted in the light path for the chrominance tubes R, G and B.

## LOW KEY CONDITIONS

|                 | build-up lag          |               | decay lag             |        |
|-----------------|-----------------------|---------------|-----------------------|--------|
|                 | $I_s/I_b = 20/300$ nA |               | $I_s/I_b = 20/300$ nA |        |
|                 | 60 ms                 | 200 ms        | 60 ms                 | 200 ms |
| XQ2427, XQ2427G | 95                    | $\approx 100$ | 7,5                   | 3 %    |
| XQ2427R         | 95                    | $\approx 100$ | 9                     | 3,5 %  |
| XQ2427B         | 95                    | $\approx 100$ | 10                    | 4 %    |

Highlight handling capability with DBC

16

MECHANICAL DATA

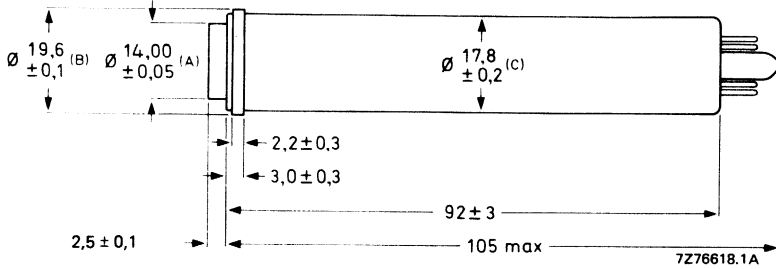

The distance between the geometrical centres of diameters A (anti-halation disc), B (signal-electrode ring), and the geometrical centre of diameter C (tube envelope) is  $\leq 200 \mu\text{m}$ .

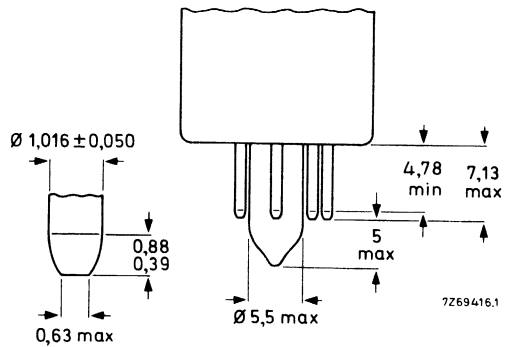
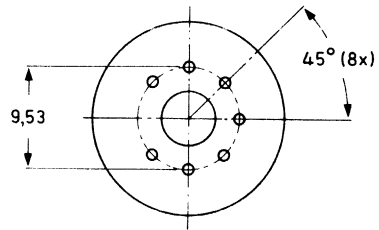
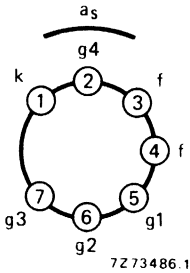

Mounting position: any

Mass:  $\approx 23 \text{ g}$

Base: EIA E7-91

**NOTES**, see also General Section

1. "Diode" electron gun is a triode gun operating in a diode mode, providing a very high beam reserve. Since the "Diode" gun operates with a positive grid 1 voltage, causing some grid current, cameras designed around XQ1427 tubes will require modification.  
N.B. Avoid continuous operation at high beam currents since this will shorten tube life. Full advantage of the high beam reserve to reduce comet-tailing and blooming can be made with DBC circuitry which, during highlights, feeds positive-going pulses derived from the video signal to grid 1, to increase the beam current momentarily.
2. The "diode" gun operates with a positive ( $\leq 15$  V) grid 1 voltage (adjusted for correct beam settings, see note 8), hence draws some grid 1 current:  
without DBC:  $\leq 1,5$  mA (peak) with blanking  
with DBC:  $\leq 8$  mA (peak) with blanking, measured with oscilloscope.  
The DBC circuitry should, in the case of highlights, supply positive-going pulses of 10 V above  $V_{g1w}$  (see note 8) and up to 8 mA peak to grid 1.  
N.B. Applying higher pulses than 10 V is not recommended since this will shorten tube life, impair resolution and may introduce oscillations.
3. Plumbicon tubes do not permit automatic sensitivity control by means of regulation of the signal electrode voltage. Adequate control is therefore to be achieved by other means (iris control and neutral density filters).  
N.B. When the tube is to be used in a camera originally designed for vidicon tubes, the automatic sensitivity control circuitry should be made inoperative and the signal electrode voltage be set to 45 V, in order to prevent damage or destruction of the target.
4. Peak value, measured with an oscilloscope.
5. The tube can withstand short excursions up to 70 °C without damage or irreversible degradation in performance.
6. For short intervals. During storage the tube face shall be covered with the plastic hood provided; when the camera is idle the lens shall be capped, in stand-by also the beam will be cut-off.
7. The operating conditions and performance data quoted relate to operation of the tube in coil unit AT1109. See relevant data of deflection/focusing assemblies.
8. The beam current  $I_B$ , as obtained by adjusting the control grid (grid 1) voltage is set to 300 nA for R and B tubes, 400 nA for black and white and G tubes.  $I_B$  is not the actual current available in the scanning beam, but is defined as the maximum amount of signal current,  $I_S$ , that can be obtained with this beam.  
In the performance figures for lag, the signal current and beam current conditions are given, e.g. as  $I_S/I_B = 20/300$  nA. This means: with a signal current of 20 nA and a beam setting which just allows a signal current of 300 nA.  
The signal currents are measured with an integrating instrument connected in the signal electrode lead and a uniform illumination of the scanned area. The peak signal currents as measured on a waveform oscilloscope will be a factor  $\alpha$  larger.  $\alpha = 100/(100 - \beta)$ ,  $\beta$  being the total blanking time in %; for the CCIR system  $\alpha = 1,3$ .
9. a. The optimum voltage ratio  $V_{g4}/V_{g3}$  to minimize beam landing errors (preferably  $< 1$  V) depends on the type of coil unit used. In the coil AT1109 a ratio of 1,75 is required. Under no circumstances should grid 4 (mesh) be allowed to operate at a voltage below that of grid 3 as this may damage the target.  
b. An attractive gain in resolving power is obtained when the tubes are operated with higher grid 3 and grid 4 potentials.  
N.B. Since such operation requires increased focusing and deflection power, special measures (air cooling, heatsinks) have to be taken in the camera design to prevent faceplate temperatures exceeding the limiting value of 50 °C, which would otherwise affect tube performance and life. See also General Operational notes.

10. Typical faceplate illumination level for the XQ2427 to produce 200 nA signal current will be approx. 10 lx. The signal currents stated for the colour tubes R, G and B will be obtained with an incident white light level (2856 K) on the filter of approx. 25 lx. These figures are based on the filters described in note 11. For filter BG12, however, a thickness of 1 mm is chosen.
11. Measuring conditions: illuminance level 4,54 lx at a colour temperature of 2856 K and the appropriate filter inserted in the light path.

Filters used are:

|         |             |       |           |      |
|---------|-------------|-------|-----------|------|
| XQ2427G | Schott      | VG9   | thickness | 1 mm |
| XQ2427B | Schott      | BG12  | thickness | 3 mm |
| XQ2427R | Schott      | OG570 | thickness | 3 mm |
|         | and Calflex | B1/K1 |           |      |

For transmission curves see General Section.

12. For true tonal rendition in black/white cameras and for true colorimetry in colour cameras an integral filter to eliminate response to near infrared radiation should be incorporated in the optical system, together with a heat reflecting filter B1/K1 or equivalent.
13. As measured with a 50 mm Leitz Summicron lens having a sine response of approximately 80% at 30 lp/mm (400 TV lines at 6,6 mm x 8,8 mm) at  $f : 5,6$  and the appropriate filter inserted in the light path. The horizontal amplitude response can be raised by means of suitable correction circuits, which affect neither the vertical resolution nor the limiting resolution.
14. **Build-up lag**  
After 10 s of darkness. The figures are typical percentages of the ultimate signal current obtained 60 ms and 200 ms, respectively, after the introduction of the illuminance.
- Decay lag**  
After the target has been illuminated for at least 5 s. The figures represent typical signals in percentages of the original signal current 60 ms and 200 ms, respectively, after removal of the illuminance.
15. A reduction of lag, especially under low key conditions is obtained when light bias (up to 5 nA peak) is applied via the optical system. Infrared light with a wavelength  $> 600$  nm in the light bias should be avoided.
16. a. With DBC applied (see note 2) the tube will properly handle highlights with a diameter of 10% of the picture height and with a brightness corresponding to 16 times peak signal white,  $I_{sp}$ .  
b. The maximum peak signal currents in the case of highlights will be  $2,5 \mu A$ . Video preamplifiers should be designed to accommodate these.

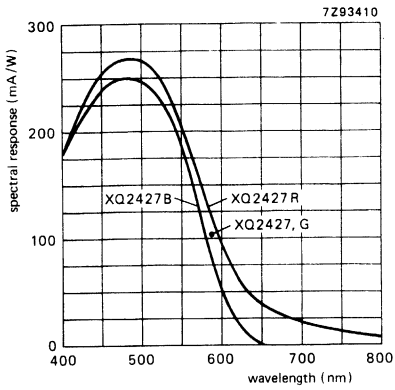

Fig. 1 Typical spectral response.

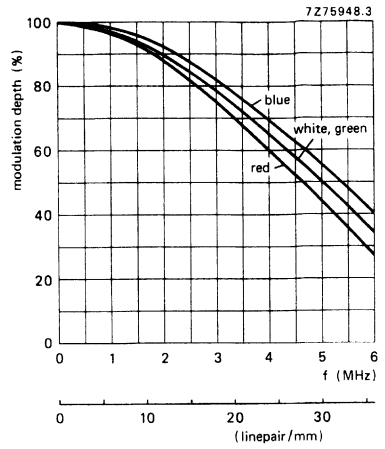

Fig. 2 Typical square wave response curve.

## CAMERA TUBES

18 mm (2/3 in) diameter Plumbicon® television camera tubes, with high resolution lead-oxide photoconductive target, for use in high quality monochrome or colour cameras for broadcast, educational or industrial applications.

The XQ3427 series comprises the following versions:

- XQ3427 for use in monochrome cameras
- XQ3427R for use in the red channel
- XQ3427G for use in the green channel
- XQ3427B for use in the blue channel

Special features are:

- New photoconductive target for increased resolution
- "Diode" electron gun with high beam reserve for dynamic beam control (DBC) to minimize comet-tailing and blooming, see notes 1 and 2
- Low output capacitance (LOC) for high signal to noise ratio.

## QUICK REFERENCE DATA

|  |                                   |
|--|-----------------------------------|
| "Diode" electron gun                   |                                   |
| Diameter                               | 17,8 mm (2/3 inch)                |
| Length                                 | approx. 108 mm                    |
| Provided with anti-halation glass disc |                                   |
| Focusing                               | magnetic                          |
| Deflection                             | magnetic                          |
| Useful target area (scanning area)     | 6,6 x 8,8 mm                      |
| Spectral response                      |                                   |
| max. at                                | approx. 500 nm                    |
| cut-off: XQ3427R                       | approx. 850 nm                    |
| XQ3427, XQ3427G                        | approx. 650 to 850 nm             |
| XQ3427B                                | approx. 650 nm                    |
| Sensitivity                            |                                   |
| XQ3427                                 | typ. 320 $\mu\text{A}/\text{lm}$  |
| XQ3427R                                | typ. 95 $\mu\text{A}/\text{lmF}$  |
| XQ3427G                                | typ. 125 $\mu\text{A}/\text{lmF}$ |
| XQ3427B                                | typ. 38 $\mu\text{A}/\text{lmF}$  |
| Resolution at 400 TV lines (5 MHz)     |                                   |
| XQ3427                                 | typ. 50 %                         |
| XQ3427R                                | typ. 45 %                         |
| XQ3427G                                | typ. 50 %                         |
| XQ3427B                                | typ. 55 %                         |
| Heater                                 | 6,3 V, 95 mA                      |

## OPTICAL DATA

|  |              |
|--|--------------|
| Quality rectangle on photoconductive target (aspect ratio 3 : 4)   | 6,6 x 8,8 mm |
| Orientation of image on target:  |              |
| For correct orientation of the image on the target the vertical scan should be essentially parallel to the plane passing through the tube axis and the gap between pins 1 and 7. |              |
| Faceplate  |              |
| Thickness  | 2,3 ± 0,1 mm |
| Refractive index   | n = 1,49     |
| Anti-halation glass disc provided with anti-reflective coating   |              |
| Thickness  | 2,5 ± 0,1 mm |
| Refractive index   | n = 1,52     |

## ACCESSORIES

|                                    |               |
|------------------------------------|---------------|
| Socket                             | type 56049    |
| Deflection and focusing coil unit: |               |
| Black/white                        | type 1109/10S |
| Colour                             | type 1109/10T |
| Mask for flare reduction           | type 56030    |

## ELECTRICAL DATA

|  |                     |             |
|--|---------------------|-------------|
| Deflection   | magnetic            |             |
| Focusing   | magnetic            |             |
| Heating, indirect by a.c. or d.c.; parallel supply   |                     |             |
| Heater voltage   | V <sub>f</sub>      | 6,3 V ± 5%  |
| Heater current at V <sub>f</sub> = 6,3 V   | I <sub>f</sub> nom. | 95 mA       |
| The heater voltage must not exceed an r.m.s. value of 9 V. For optimum performance (lifetime and registration stability) stabilization of the heater voltage is recommended. |                     |             |
| Capacitance  |                     |             |
| Signal electrode to all  | C <sub>as</sub>     | typ. 1,5 pF |
| This capacitance, which is effectively the output impedance, increases when the tube is inserted in the coil unit.   |                     |             |



**LIMITING VALUES** (Absolute maximum rating system)

notes

Unless otherwise stated, all voltages are referred to the cathode.

|  |             |      |              |   |
|--|-------------|------|--------------|---|
| Signal electrode voltage                     | $V_{as}$    | max. | 50 V         | 4 |
| Grid 4 voltage                               | $V_{g4}$    | max. | 1000 V       |   |
| Grid 3 voltage                               | $V_{g3}$    | max. | 750 V        |   |
| Voltage between grid 4 and grid 3            | $V_{g4/g3}$ | max. | 400 V        |   |
| Grid 2 voltage                               | $V_{g2}$    | max. | 350 V        |   |
| Grid 1 voltage,                              |             |      |              |   |
| positive                                     | $V_{g1}$    | max. | 25 V         |   |
| negative                                     | $-V_{g1}$   | max. | 200 V        |   |
| Grid 1 current ( $\approx I_k$ )             | $I_{g1}$    | max. | 5 mA         | 5 |
| Grid 1 current ( peak with DBC)              | $I_{g1p}$   | max. | 8 mA         | 2 |
| Cathode heating time before drawing          |             |      |              |   |
| cathode current                              | $t_h$       | min. | 1 min        |   |
| Cathode to heater voltage                    |             |      |              |   |
| positive peak                                | $V_{kfp}$   | max. | 125 V        |   |
| negative peak                                | $-V_{kfp}$  | max. | 50 V         |   |
| External resistance between                  |             |      |              |   |
| cathode and heater at $V_{kfp} > 10$ V       | $R_{kf}$    | min. | 2 k $\Omega$ |   |
| Ambient temperature, storage and operation   | $T_{amb}$   | max. | 50 °C        |   |
|  |             | min. | -30 °C       |   |
| Faceplate temperature, storage and operation | $T$         | max. | 50 °C        | 6 |
|  |             | min. | -30 °C       |   |
| Faceplate illuminance                        | $E$         | max. | 500 lx       | 7 |

**OPERATING CONDITIONS**

8

For a scanned area of 6,6 x 8,8 mm.

|  |             |  |                 |
|--|-------------|--|-----------------|
| Cathode voltage                          | $V_k$       | 0 V  |                 |
| Signal electrode voltage                 | $V_{as}$    | 45 V   |                 |
| Beam current                             | $I_b$       |  | 9               |
|  |             | <u>low voltage mode</u>   <u>high voltage mode</u> |                 |
| Grid 4 voltage                           | $V_{g4}$    | 500  | 750 V   10      |
| Grid 3 voltage                           | $V_{g3}$    | 285  | 430 V   10      |
| Grid 2 voltage                           | $V_{g2}$    | 300  | 300 V           |
| Grid 1 voltage                           | $V_{g1}$    |  |                 |
| Blanking voltage on grid 2, peak to peak | $V_{g1p-p}$ |  | 25 V            |
| Faceplate illuminance                    |             |  | 0 to 10 lx   10 |
| Faceplate temperature                    |             |  | 20 to 45 °C     |

**ELECTRON GUN CHARACTERISTICS**

Cut off

Grid 1 voltage for cut-off at  $V_{g2} = 300$  V,

without blanking

 $V_{g1} \leq -10$  to 0 V

Grid 1 voltage for normal beam setting

 $V_{g1w} \leq 15$  V

9

Blanking voltage, peak to peak

on grid 1

 $V_{g1p-p} = 25$  V

on cathode

 $V_{kp-p} = 25$  V

Grid 1 current at normally required

beam currents

 $I_{g1} \leq 1,5$  mA

Grid 2 current at normally required

beam currents

 $I_{g2} \leq 0,1$  mA

# XQ3427 SERIES

## PERFORMANCE

|  |            |        |                 |       |
|--|------------|--------|-----------------|-------|
| Dark current   | $I_d$      | $\leq$ | 1,0 nA          | notes |
| Sensitivity at colour temperature of illuminance = 2856 K  |            |        |                 | 12    |
| XQ3427   | min. 275   | typ.   | 320 $\mu$ A/lm  |       |
| XQ3427R  | min. 80    | typ.   | 95 $\mu$ A/lmF  |       |
| XQ3427G  | min. 95    | typ.   | 125 $\mu$ A/lmF |       |
| XQ3427B  | min. 35    | typ.   | 38 $\mu$ A/lmF  |       |
| Gamma of transfer characteristics  |            |        | 0,95 $\pm$ 0,05 |       |
| Spectral response, max. at   | approx.    |        | 500 nm          | 13    |
| Spectral response, cut-off at  | approx.    |        | 650 to 850 nm   |       |
| Spectral response curves   | see Fig. 1 |        |                 |       |
| Resolution   |            |        |                 | 14    |
| Modulation depth, i.e. uncompensated amplitude response at 400 TV lines at the centre of the picture (5 MHz) |            |        |                 |       |

|  | XQ3427 | XQ3427R | XQ3427G | XQ3427B |    |
|--|--------|---------|---------|---------|----|
| Highlight signal current $I_s$           | 200    | 150     | 200     | 150     | nA |
| Beam current $I_b$                       | 400    | 300     | 400     | 300     | nA |
| Modulation depth at 400 TV lines (5 MHz) |        |         |         |         |    |
| high voltage mode, typ.                  | 50     | 45      | 50      | 55      | %  |
| min.                                     | 45     | 40      | 45      | 50      | %  |
| low voltage mode, typ.                   | 45     | 40      | 45      | 50      | %  |
| min.                                     | 40     | 35      | 40      | 45      | %  |

Modulation transfer characteristics: see Fig. 2

Lag (typical values, without light bias)

15,16

Light source with a colour temperature of 2856 K. Appropriate filter inserted in the light path for the chrominance tubes R, G and B

## LOW KEY CONDITIONS

|                 | build-up lag          |               | decay lag             |        |
|-----------------|-----------------------|---------------|-----------------------|--------|
|                 | $I_s/I_b = 20/300$ nA |               | $I_s/I_b = 20/300$ nA |        |
|                 | 60 ms                 | 200 ms        | 60 ms                 | 200 ms |
| XQ3427, XQ3427G | 95                    | $\approx$ 100 | 7,5                   | 2,5 %  |
| XQ3427R         | 95                    | $\approx$ 100 | 9                     | 3,5 %  |
| XQ3427B         | 95                    | $\approx$ 100 | 10                    | 3,5 %  |

Highlight handling capability with DBC

17

MECHANICAL DATA

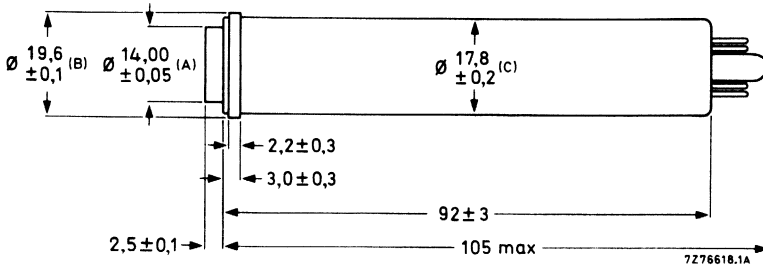

The distance between the geometrical centres of diameters A (anti-halation disc), B (metal ring), and the geometrical centre of diameter C (tube envelope) is  $\leq 200 \mu\text{m}$ .

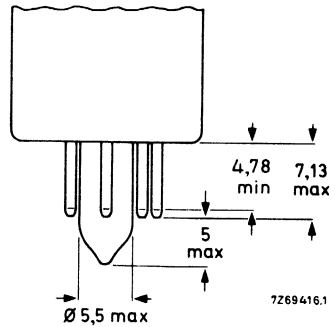
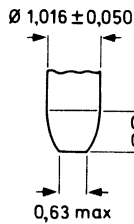
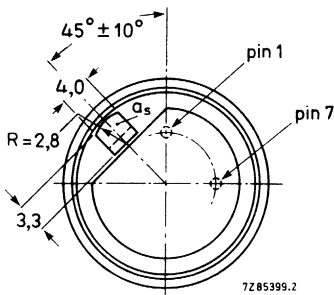
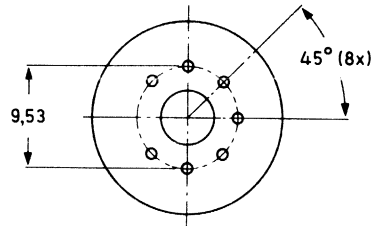
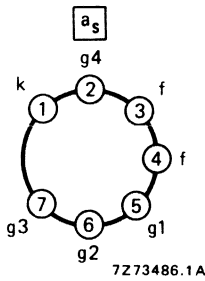

Mounting position: any

Mass:  $\approx 23 \text{ g}$

Base: EIA E7-91

**NOTES**, see also General Section

1. "Diode" electron gun is a triode gun operating in a diode mode, providing a very high beam reserve. Since the "Diode" gun operates with a positive grid 1 voltage, causing some grid current, cameras designed around XQ1427 tubes will require modification.  
N.B. Avoid continuous operation at high beam currents since this will shorten tube life. Full advantage of the high beam reserve to reduce comet-tailing and blooming can be made with DBC circuitry which, during highlights, feeds positive-going pulses derived from the video signal to grid 1, to increase the beam current momentarily.
2. The "diode" gun operates with a positive ( $\leq 15$  V) grid 1 voltage (adjusted for correct beam settings, see note 9), hence draws some grid 1 current:  
without DBC:  $\leq 1,5$  mA (peak) with blanking  
with DBC:  $\leq 8$  mA (peak) with blanking measured with oscilloscope.  
The DBC circuitry should, in the case of highlights, supply positive-going pulses of 10 V above  $V_{g1w}$  (see note 9) and up to 8 mA peak to grid 1.  
N.B. Applying higher pulses than 10 V is not recommended since this will shorten tube life, impair resolution and may introduce oscillations.
3. Metal ring not electrically connected.
4. Plumbicon tubes do not permit automatic sensitivity control by means of regulation of the signal electrode voltage. Adequate control is therefore to be achieved by other means (iris control and neutral density filters).  
N.B. When the tube is to be used in a camera originally designed for vidicon tubes, the automatic sensitivity control circuitry should be made inoperative and the signal electrode voltage be set to 45 V, in order to prevent damage or destruction of the target.
5. Peak value, measured with an oscilloscope.
6. The tube can withstand short excursions up to 70 °C without damage or irreversible degradation in performance.
7. For short intervals. During storage the tube face shall be covered with the plastic hood provided; when the camera is idle the lens shall be capped, in stand-by also the beam will be cut-off.
8. The operating conditions and performance data quoted relate to operation of the tube in coil unit AT1109. See relevant data of deflection/focusing assemblies.
9. The beam current  $I_b$ , as obtained by adjusting the control grid (grid 1) voltage is set to 300 nA for R and B tubes, 400 nA for black and white and G tubes.  $I_b$  is not the actual current available in the scanning beam, but is defined as the maximum amount of signal current,  $I_s$ , that can be obtained with this beam.  
In the performance figures for lag, the signal current and beam current conditions are given, e.g. as  $I_s/I_b = 20/300$  nA. This means: with a signal current of 20 nA and a beam setting which just allows a signal current of 300 nA.  
The signal currents are measured with an integrating instrument connected in the signal electrode lead and a uniform illumination of the scanned area. The peak signal currents as measured on a waveform oscilloscope will be a factor  $\alpha$  larger.  $\alpha = 100 / \{100 - \beta\}$ ,  $\beta$  being the total blanking time in %; for the CCIR system  $\alpha = 1,3$ .
10. a. The optimum voltage ratio  $V_{g4}/V_{g3}$  to minimize beam landing errors (preferably  $< 1$  V) depends on the type of coil unit used. In the coil AT1109 a ratio of 1,75 is required. Under no circumstances should grid 4 (mesh) be allowed to operate at a voltage below that of grid 3 as this may damage the target.  
b. An attractive gain in resolving power is obtained when the tubes are operated with higher grid 3 and grid 4 potentialials.  
N.B. Since such operation requires increased focusing and deflection power, special measures (air cooling, heatsinks) have to be taken in the camera design to prevent faceplate temperatures exceeding the limiting value of 50 °C, which would otherwise affect tube performance and life. See also General Operational notes.

11. Typical faceplate illumination level for the XQ3427 to produce 200 nA signal current will be approx. 10 lx. The signal currents stated for the colour tubes R, G and B will be obtained with an incident white light level (2856 K) on the filter of approx. 25 lx. These figures are based on the filters described in note 12. For filter BG12, however, a thickness of 1 mm is chosen.
12. Measuring conditions: illuminance level 4,54 lx at a colour temperature of 2856 K and the appropriate filter inserted in the light path.

Filters used are:

|         |             |       |           |      |
|---------|-------------|-------|-----------|------|
| XQ3427G | Schott      | VG9   | thickness | 1 mm |
| XQ3427B | Schott      | BG12  | thickness | 3 mm |
| XQ3427R | Schott      | OG570 | thickness | 3 mm |
|         | and Calflex | B1/K1 |           |      |

For transmission curves see General Section.

13. For true tonal rendition in black/white cameras and for true colorimetry in colour cameras an integral filter to eliminate response to near infrared radiation should be incorporated in the optical system, together with a heat reflecting filter B1/K1 or equivalent.
14. As measured with a 50 mm Leitz Summicron lens having a sine response of approximately 80% at 30 lp/mm (400 TV lines at 6,6 mm x 8,8 mm) at  $f : 5,6$  and the appropriate filter inserted in the light path. The horizontal amplitude response can be raised by means of suitable correction circuits, which affect neither the vertical resolution nor the limiting resolution.
15. **Build-up lag**  
After 10 s of darkness. The figures are typical percentages of the ultimate signal current obtained 60 ms and 200 ms, respectively, after the introduction of the illuminance.
- Decay lag**  
After the target has been illuminated for at least 5 s. The figures represent typical signals in percentages of the original signal current 60 ms and 200 ms, respectively, after removal of the illuminance.
16. A reduction of lag, especially under low key conditions is obtained when light bias up to 5 nA (peak) is applied via the optical system. Infrared light with a wavelength  $> 600$  nm in the light bias should be avoided.
17. a. With DBC applied (see note 2) the tube will properly handle highlights with a diameter of 10% of the picture height and with a brightness corresponding to 16 times peak signal white,  $I_{sp}$ .  
b. The maximum peak signal currents in the case of highlights will be  $2,5 \mu A$ . Video preamplifiers should be designed to accommodate these.

# XQ3427 SERIES

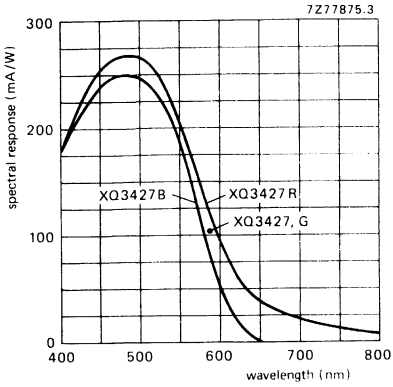

Fig. 1 Typical spectral responses.

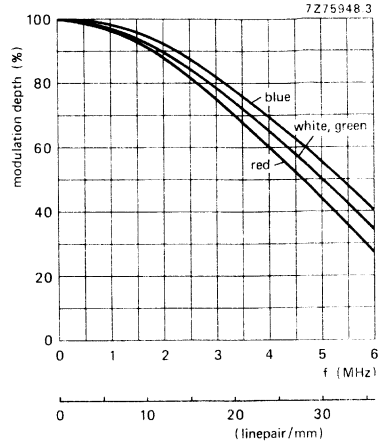

Fig 2 Typical square wave response curves (high voltage mode).

## CAMERA TUBES

18 mm (2/3 in) diameter Plumbicon® television camera tubes with high resolution leadoxide photoconductive target, magnetic focusing electrostatic deflection.

The XQ3457 series is intended for use in high quality monochrome and colour cameras in broadcast, educational and industrial applications.

The XQ3457 series comprises the following versions:

- XQ3457 for monochrome cameras;
- XQ3457R for the red channel of colour cameras;
- XQ3457G for the green channel;
- XQ3457B for the blue channel.

Special features are:

- MS type (Magnetic-Static) providing short tube length
- New photoconductive target for increased resolution
- "Diode" electron gun for D.B.C. (Dynamic Beam Control) to minimize comet tailing and highlight blooming (notes 1 and 2)
- Low output capacitance for high signal to noise ratio

## QUICK REFERENCE DATA

"Diode" electron gun

|   |                      |
|---|----------------------|
| Diameter  | 17,8 mm (2/3")       |
| Length  | approx. 87,5 mm      |
| Provided with anti-halation glass disc, thickness | 2,5 mm               |
| Focusing  | magnetic             |
| Deflection  | electrostatic        |
| Useful target area                                | 6,6 mm x 8,8 mm      |
| Spectral response max. at                         | ≈ 500 nm             |
| Spectral response cut-off                         |                      |
| XQ3457R   | ≈ 850 nm             |
| XQ3457, XQ3457G, XQ3457B                          | ≈ 650 nm             |
| Sensitivity                                       |                      |
| XQ3457  | typ. 320 $\mu$ A/lm  |
| XQ3457R   | typ. 100 $\mu$ A/lmF |
| XQ3457G   | typ. 125 $\mu$ A/lmF |
| XQ3457B   | typ. 36 $\mu$ A/lmF  |
| Modulation depth at 400 TV lines (5 MHz)          |                      |
| XQ3457  | typ. 50%             |
| Heater  | 6,3 V; 95 mA         |

® Registered trademark for television camera tube.

# XQ3457 SERIES

## OPTICAL DATA

Dimensions of quality area of target (aspect ratio 3 : 4) 6,6 mm x 8,8 mm

Orientation of image on target

For correct orientation of the image on the target the horizontal scan should be essentially parallel to the long side of the anti-halation glass disc.

Faceplate  
thickness 2,3 ± 0,1 mm  
refractive index 1,49

Anti-halation glass disc  
thickness 2,5 ± 0,1 mm  
refractive index 1,52

## ACCESSORIES

Socket 56601  
Focusing coil unit KV4722  
or equivalent

## ELECTRICAL DATA

Deflection electrostatic

Focusing magnetic

## HEATING

Indirect by a.c. or d.c. parallel supply

Heater voltage  $V_f$  6,3 V ± 5 %

Heater current  $I_f$  nom. 95 mA

The heater current and heater voltage must never exceed 150 mA and 9,5 V (r.m.s.)

For optimum performance (lifetime and registration stability) stabilization of the heater voltage is recommended.

## INTERELECTRODE CAPACITANCE

Signal electrode to all  $C_{as}$  typ. 3 pF

This capacitance increases slightly when the tube is inserted in the coil unit.



**LIMITING VALUES** (Absolute maximum rating system)

notes

All voltages are referred to the cathode, unless otherwise stated.

|   |             |      |              |   |
|---|-------------|------|--------------|---|
| Signal electrode voltage  | $V_{as}$    | max. | 50 V         |   |
| Grid 4 voltage (mesh electrode)                                   | $V_{g2}$    | max. | 500 V        |   |
| Grid 3 voltage (deflection electrode, DC component)               | $V_{g3}$    | max. | 300 V        |   |
| Voltage between grid 4 and grid 3                                 | $V_{g3/g4}$ | max. | 300 V        |   |
| Grid 2 voltage  | $V_{g2}$    | max. | 350 V        |   |
| Grid 1 voltage positive   | $V_{g1}$    | max. | 20 V         |   |
| Grid 1 voltage negative   | $-V_{g1}$   | max. | 50 V         |   |
| Grid 1 current ( $\approx$ cathode current)                       | $I_{g1}$    | max. | 5 mA         | 3 |
| Grid 1 current (peak current with DBC)                            | $I_{g1p}$   | max. | 8 mA         | 2 |
| Cathode to heater voltage positive peak                           | $V_{kfp}$   | max. | 125 V        |   |
| Cathode to heater voltage negative peak                           | $-V_{kfp}$  | max. | 50 V         |   |
| Cathode heating time before drawing cathode current               | $t_h$       | min. | 1 min        |   |
| External resistance between cathode and heater at $V_{kf} > 10$ V | $R_{kf}$    | min. | 2 k $\Omega$ |   |
| Ambient temperature, storage and operation                        | $T_{amb}$   | max. | 50 °C        |   |
|   |             | min. | -30 °C       |   |
| Faceplate temperature, storage and operation                      | T           | max. | 50 °C        | 4 |
|   |             | min. | -30 °C       |   |
| Faceplate illuminance   | E           | max. | 500 lx       | 5 |

## OPERATING CONDITIONS

for a scanned area of 6,6 mm x 8,8 mm

|                                       |               |             | notes |
|---------------------------------------|---------------|-------------|-------|
| Cathode voltage                       | $V_k$         | 0 V         | 6     |
| Signal electrode voltage              | $V_{as}$      | 45 V        |       |
| Beam current                          | $I_b$         |             | 7     |
| Grid 4 voltage                        | $V_{g4}$      | 340 V       |       |
| Grid 3 voltage (DC component)         | $V_{g3}$      | 220 V       |       |
| Grid 2 voltage                        | $V_{g2}$      | 250 V       |       |
| Grid 1 voltage                        | $V_{g1}$      | 0 to 10 V   | 7     |
| Blanking voltage on grid 1, peak-peak | $V_{g1p-p}$   | 25 V        |       |
| Beam focus magnetic field             |               | 7,3 mT      | 9     |
| Grid 3 deflection voltage, horizontal | $V_{g3x p-p}$ | 155 V       |       |
| Grid 3 deflection voltage, vertical   | $V_{g3y p-p}$ | 116 V       |       |
| Faceplate illuminance                 | E             | 0 to 10 lx  | 10    |
| Faceplate temperature                 | $T_{as}$      | 20 to 45 °C |       |

## ELECTRON GUN CHARACTERISTICS

|  |             |            |  |
|--|-------------|------------|--|
| Grid 1 voltage for cut-off<br>at $V_{g2} = 250$ V without blanking   | $V_{g1}$    | -10 to 0 V |  |
| Grid 1 voltage for normal beam current                               | $V_{g1w}$   | ≤ 10 V     |  |
| Blanking voltage with respect to $V_{g1w}$ peak to peak<br>on grid 1 | $V_{g1p-p}$ | 25 V       |  |
| on cathode   | $V_k p-p$   | 25 V       |  |
| Grid 1 current at normally required beam currents                    | $I_{g1}$    | ≤ 3 mA     |  |
| Grid 2 current at normally required beam currents                    | $I_{g2}$    | ≤ 0,1 mA   |  |

## PERFORMANCE

|  |          |                     |    |
|--|----------|---------------------|----|
| Dark current   | $I_d$    | ≤ 2 nA              |    |
| Sensitivity at colour temperature of 2856K   |          |                     | 11 |
| XQ3457   | min. 270 | typ. 320 $\mu A/m$  |    |
| XQ3457R  | min. 75  | typ. 100 $\mu A/mF$ |    |
| XQ3457G  | min. 90  | typ. 125 $\mu A/mF$ |    |
| XQ3457B  | min. 33  | typ. 36 $\mu A/mF$  |    |
| Gamma of transfer characteristic   |          | 0,95 ± 0,05         |    |
| Spectral response  |          |                     | 12 |
| max. response at   |          | ≈ 500 nm            |    |
| cut-off XQ3457R  |          | ≈ 850 nm            |    |
| cut-off XQ3457, XQ3457G  |          | ≈ 650 nm            |    |
| cut-off XQ3457B  |          | ≈ 650 nm            |    |
| response curves  |          | see Fig. 5          |    |
| Resolution   |          |                     | 13 |
| Modulation depth, i.e. uncompensated amplitude response at 400 TV<br>lines at centre of the picture. |          |                     |    |

Table 1

|  |       | XQ3457 | XQ3457R | XQ3457G | XQ3457B |
|--|-------|--------|---------|---------|---------|
| Highlight signal current                         | $I_s$ | 200 nA | 150 nA  | 200 nA  | 150 nA  |
| Beam current                                     | $I_b$ | 400 nA | 300 nA  | 400 nA  | 300 nA  |
| Modulation depth at 400 TV lines<br>(5 MHz) in % | typ.  | 50     | 40      | 50      | 55      |
|  | min.  | 40     | 32      | 40      | 40      |

Modulation transfer characteristics see Fig. 6.

Lag (typical values, no light bias applied).

note 14, 15

Light source with a colour temperature of 2856 K.

Appropriate filter inserted in light path.

Table 2

|         | build-up lag          |        | decay lag             |        |
|---------|-----------------------|--------|-----------------------|--------|
|         | $I_s/I_b = 20/300$ nA |        | $I_s/I_b = 20/300$ nA |        |
|         | 60 ms                 | 200 ms | 60 ms                 | 200 ms |
| XQ3457  | 95                    | ≈ 100% | 8                     | 3 %    |
| XQ3457G | 95                    | ≈ 100% | 8                     | 3 %    |
| XQ3457R | 95                    | ≈ 100% | 9                     | 3,5%   |
| XQ3457B | 95                    | ≈ 100% | 10                    | 4 %    |

Highlight handling capability with DBC.

note 16



NOTES, see also General Section

1. "Diode" electron gun is a triode gun operating in a diode mode, providing a very high beam reserve. Since the "Diode" gun operates with a positive grid 1 voltage, causing some grid current.

**N.B.**

Avoid continuous operation at high beam currents since this will shorten tube life. Full advantage of the high beam reserve to reduce comet-tailing and blooming can be made with DBC circuitry which, during highlights, feeds positive-going pulses derived from the video signal to grid 1, to increase the beam current momentarily.

2. The "Diode" gun operates with a positive ( $\leq 10$  V) grid 1 voltage (adjusted for correct beam settings, see note 9), hence draws some grid 1 current:

without DBC:  $\leq 3$  mA (peak) with blanking

with DBC:  $\leq 5$  mA (peak) with blanking measured with oscilloscope.

The DBC circuitry should, in the case of highlights, supply positive-going pulses of 8 V<sub>p-p</sub> and up to 8 mA<sub>p-p</sub> peak to grid 1.

**N.B.**

Applying higher pulses than 8 V is not recommended since this will shorten tube life, impair resolution and may introduce oscillations.

3. Maximum d.c. value.
4. The tube can withstand short excursions up to 70 °C without damage or irreversible degradation in performance.
5. For short intervals. During storage the tube face shall be covered with the plastic hood provided; when the camera is idle the lens shall be capped, in stand-by also the beam will be cut-off.
6. The operating conditions and performance data quoted relate to operation in coil unit KV4722. See relevant data.
7. The beam current  $I_b$ , as obtained by adjusting the control grid (grid 1) voltage is set to 300 nA for R and B tubes, 400 nA for black and white and G tubes.  $I_b$  is not the actual current available in the scanning beam, but is defined as the maximum amount of signal current,  $I_s$ , that can be obtained with this beam.
8. The optimum voltage ratio  $V_{g3}/V_{g4}$  to minimize beam landing errors (preferably  $< 1$  V) depends on the type of coil unit used.
9. See relevant data of deflection/focusing assemblies.
10. Typical faceplate illumination level for the XQ3457 to produce 200 nA signal current will be approx. 10 lx. The signal currents stated for the colour tubes R, G and B will be obtained with an incident white light level (2856 K) on the filter approx. 25 lx. These figures are based on the filters described in note 11. For filter BG12, however, a thickness of 1 mm is chosen.
11. Measuring conditions: illuminance level before the filter 4,54 lx at a colour temperature of 2856 K and the appropriate filter inserted in the light path for the chrominance tubes. Filters used are:

|         |             |       |           |      |
|---------|-------------|-------|-----------|------|
| XQ3457G | Schott      | VG9   | thickness | 1 mm |
| XQ3457B | Schott      | BG12  | thickness | 3 mm |
| XQ3457R | Schott      | OG570 | thickness | 3 mm |
|         | and Calflex | B1/K1 |           |      |

For transmission curves see General Section.

NOTES (continued)

12. For true tonal rendition in monochrome cameras, and for true colorimetry in colour cameras, an integral filter to eliminate response to near infrared radiation must be incorporated in the optical system.
13. — Uncompensated amplitude response at 5 MHz at the centre of the picture.
  - The figures shown represent the horizontal amplitude response of the tube as obtained with lens aperture of  $f : 5.6$ .
  - The highlight signal current and beam current conditions are given,  $I_s = 200 \text{ nA}/I_b = 400 \text{ nA}$  for monochrome and G tubes, and  $I_s = 150 \text{ nA}/I_b = 300 \text{ nA}$  for R and B tubes.
  - The horizontal amplitude response can be raised by means of suitable correction circuits, which affect neither the vertical resolution nor the limiting resolution.
14. *Build up lag.* After 10 s of darkness. The figures represent typical signals in percentages of the ultimate signal current, obtained 60 ms or 200 ms respectively, after introduction of the illuminance.
 

*Decay lag.* After the target has been illuminated for at least 5 s. The figures represent typical signals in percentages of the original signal current, 60 ms or 200 ms respectively, after removal of the illuminance.
15. An attractive reduction of lag, especially under low key conditions may be obtained when light bias (up to 5 nAp-p) is applied via the optical system. Infrared light with a wavelength  $> 600 \text{ nm}$  in the light bias should be avoided.
16. — With DBC applied (see Note 2) the tube will properly handle highlights with a diameter of 10% of picture height and with a brightness corresponding to 16 times peak signal white.
  - The max. peak signal currents in the case of highlights will be  $2,5 \mu\text{A}$ . Video preamplifiers must be designed to accommodate these.

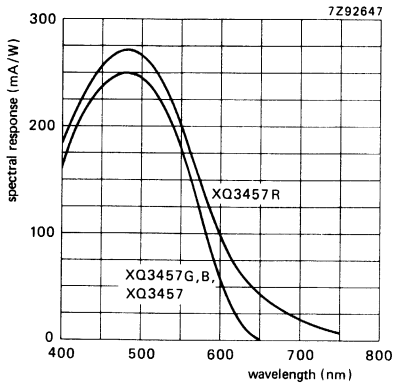

Fig. 5 Typical spectral response curves.

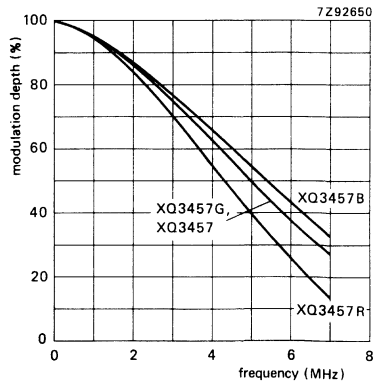

Fig. 6 Typical square-wave response curves.

## CAMERA TUBES

18 mm (2/3 inch) diameter Plumbicon® television camera tubes with standard resolution leadoxide photoconductive target, intended for use in low-weight monochrome and colour cameras in broadcast, educational or industrial applications.

The XQ3467 series comprises the following versions:

- XQ3467 for monochrome cameras
- XQ3467R for the red channel of colour cameras
- XQ3467G for the green channel
- XQ3467B for the blue channel

Special features are:

- Low power consumption due to electrostatic focusing
- Low weight

## QUICK REFERENCE DATA

|                                     |                       |         |         |                                      |
|-------------------------------------|-----------------------|---------|---------|--------------------------------------|
| Separate mesh                       |                       |         |         |                                      |
| Diameter                            | max. 18 mm (2/3 inch) |         |         |                                      |
| Length                              | approx. 108           |         |         |                                      |
| Anti-halation glass disc, thickness | 3,7 mm                |         |         |                                      |
| Focusing                            | electrostatic         |         |         |                                      |
| Deflection                          | magnetic              |         |         |                                      |
| Useful target area (scanning area)  | 6,6 mm x 8,8 mm       |         |         |                                      |
| Spectral response                   | approx. 500 nm        |         |         |                                      |
| max. at                             | approx. 650 to 850 nm |         |         |                                      |
| cut-off at                          |                       |         |         |                                      |
| type                                | XQ3467                | XQ3467R | XQ3467G | XQ3467B                              |
| Sensitivity, typ.                   | 375                   | 95      | 150     | 36 $\mu\text{A}/\text{lm}(\text{F})$ |
| Resolution at 320 TV lines (4 MHz)  | 45                    | 40      | 45      | 50 %                                 |
| Heater                              | 6 V, 75 mA            |         |         |                                      |

## OPTICAL DATA

Quality rectangle on photoconductive target  
(aspect ratio 3 : 4) 6,6 mm x 8,8 mm

Orientation of image on target

For correct orientation of the image on the target the horizontal scan should be essentially parallel to the plane passing through the tube axis and the index pin.

Faceplate

thickness 2,3 ± 0,1 mm  
refractive index 1,49

Anti-halation glass disc with AR-coating

thickness 3,7 ± 0,1 mm  
refractive index 1,52

® Registered trade mark for television camera tube.

## ACCESSORIES

|                        |                           |
|------------------------|---------------------------|
| Socket                 | type 56604                |
| → Deflection coil unit | type KV4780 or equivalent |

## ELECTRICAL DATA

### Heating

notes

Indirect by a.c. or d.c.; parallel supply

|                                  |       |      |              |
|----------------------------------|-------|------|--------------|
| Heater voltage                   | $V_f$ |      | 6 V $\pm$ 5% |
| Heater current, at $V_f = 6,0$ V | $I_f$ | nom. | 75 mA        |

The heater voltage must never exceed 9 V r.m.s.

For optimum performance (lifetime and registration stability) use a stabilized supply.

### Inter-electrode capacitance

|                                       |          |      |        |
|---------------------------------------|----------|------|--------|
| Signal electrode to any other contact | $C_{as}$ | typ. | 2,5 pF |
|---------------------------------------|----------|------|--------|

This capacitance increases slightly when the tube is inserted in the coil unit.

### Deflection

magnetic

### Focusing

electrostatic

## LIMITING VALUES (Absolute maximum rating system)

All voltages are referred to the cathode, unless otherwise stated

|   |             |      |        |   |
|---|-------------|------|--------|---|
| Signal electrode voltage                            | $V_{as}$    | max. | 50 V   |   |
| Grid 6 voltage + grid 3 voltage (int. connected)    | $V_{g3+6}$  | max. | 1200 V |   |
| Grid 5 voltage                                      | $V_{g5}$    | max. | 600 V  |   |
| Grid 4 voltage, focus                               | $V_{g4}$    | max. | 250 V  |   |
| Grid 2 voltage                                      | $V_{g2}$    | max. | 350 V  |   |
| Grid 1 voltage, positive                            | $V_{g1}$    | max. | 0 V    |   |
| Grid 1 voltage, negative                            | $-V_{g1}$   | max. | 200 V  |   |
| Cathode to heater voltage, positive peak            | $V_{kf p}$  | max. | 125 V  |   |
| Cathode to heater voltage, negative peak            | $-V_{kf p}$ | max. | 50 V   |   |
| Cathode heating time before drawing cathode current | $t_h$       | min. | 1 min  |   |
| Ambient temperature, storage and operation          | $T_{amb}$   | max. | 50 °C  |   |
|   |             | min. | -30 °C |   |
| Faceplate temperature, storage and operation        | T           | max. | 50 °C  | 1 |
|   |             | min. | -30 °C |   |
| Faceplate illuminance (intermittent)                | E           | max. | 500 lx | 2 |



**OPERATING CONDITIONS AND PERFORMANCE**

for a scanned area of 6,6 mm x 8,8 mm

notes  
3**Conditions**

|  |                     |              |   |
|--|---------------------|--------------|---|
| Cathode voltage                          | $V_k$               | 0 V          |   |
| Signal electrode voltage                 | $V_{as}$            | 45 V         |   |
| Beam current                             | $I_b$               |              | 4 |
| Grid 6 voltage + grid 3 voltage          | $V_{g3+6}$          | 1000 V       |   |
| Grid 5 voltage                           | $V_{g5}$            | 500 V        |   |
| Grid 4 voltage, focus                    | $V_{g4}$            | 90 to 130 V  |   |
| Grid 2 voltage                           | $V_{g2}$            | 300 V        |   |
| Grid 1 voltage                           | $V_{g1}$            | -10 to -30 V | 4 |
| Blanking voltage on grid 1, peak to peak | $V_{g1\text{ p-p}}$ | 75 V         |   |
| Faceplate illuminance                    | E                   | 0 to 10 lx   | 5 |
| Faceplate temperature                    | T                   | 20 to 45 °C  |   |

**Electron gun characteristics**

## Cut-off

|   |                     |               |   |
|---|---------------------|---------------|---|
| Grid 1 voltage for cut-off without blanking | $V_{g1}$            | -30 to -100 V |   |
| Grid 1 voltage for 400 nA beam current      | $V_{g1w}$           | -10 to -30 V  | 4 |
| Blanking voltage, peak to peak on grid 1    | $V_{g1\text{ p-p}}$ | 75 V          |   |

**Performance**

|   |       |     |                                   |   |
|---|-------|-----|-----------------------------------|---|
| Dark current  | $I_d$ | ≤   | 1,0 nA                            |   |
| Sensitivity at colour temperature of illuminance = 2856 K |       |     |                                   | 6 |
| XQ3467  | min.  | 325 | typ. 375 $\mu\text{A}/\text{lm}$  |   |
| XQ3467R   | min.  | 75  | typ. 95 $\mu\text{A}/\text{lmF}$  |   |
| XQ3467G   | min.  | 110 | typ. 140 $\mu\text{A}/\text{lmF}$ |   |
| XQ3467B   | min.  | 32  | typ. 36 $\mu\text{A}/\text{lmF}$  |   |
| Gamma of transfer characteristic                          |       |     | 0,95 + 0,05                       |   |
| Spectral response:  |       |     |                                   |   |
| max. response at  |       | ≈   | 500 nm                            | 7 |
| cut-off XQ3467R   |       | ≈   | 850 nm                            |   |
| cut-off XQ3467, XQ3467G                                   |       | ≈   | 650 to 850 nm                     |   |
| cut-off XQ3467B   |       | ≈   | 650 nm                            |   |
| response curves   |       |     | see Fig. 1                        |   |

## Resolution

Modulation depth, i.e. uncompensated amplitude response at 320 TV lines at the centre of the picture.

notes  
8

|  |       | XQ3467 | XQ3467R | XQ3467G | XQ3467B |
|--|-------|--------|---------|---------|---------|
| Highlight signal current                         | $I_s$ | 200 nA | 150 nA  | 200 nA  | 150 nA  |
| Beam current                                     | $I_b$ | 400 nA | 300 nA  | 400 nA  | 300 nA  |
| Modulation depth at<br>320 TV lines (4 MHz) in % | typ.  | 45 %   | 40 %    | 45 %    | 50 %    |
|  | min.  | 35 %   | 30 %    | 35 %    | 40 %    |

Modulation transfer characteristics

see Fig. 2

Lag (typical values, no light bias applied)

Light source with a colour temperature of 2856 K  
Appropriate filter inserted in light path

9, 10

Low key conditions (percentages)

|         | build-up lag          |        | decay lag             |        |
|---------|-----------------------|--------|-----------------------|--------|
|         | $I_s/I_b = 20/300$ nA |        | $I_s/I_b = 20/300$ nA |        |
|         | 60 ms                 | 200 ms | 60 ms                 | 200 ms |
| XQ3467  | 95                    | ~ 100  | 8,0                   | 3,0    |
| XQ3467R | 95                    | ~ 100  | 8,0                   | 3,0    |
| XQ3467G | 95                    | ~ 100  | 8,0                   | 3,0    |
| XQ3467B | 95                    | ~ 100  | 9,0                   | 3,5    |

MECHANICAL DATA

Dimensions in mm

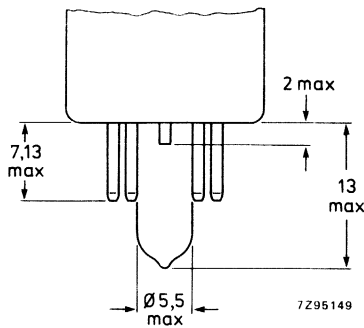
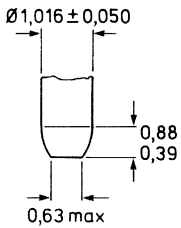
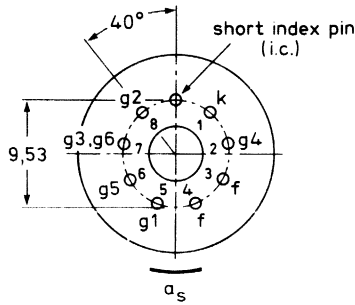
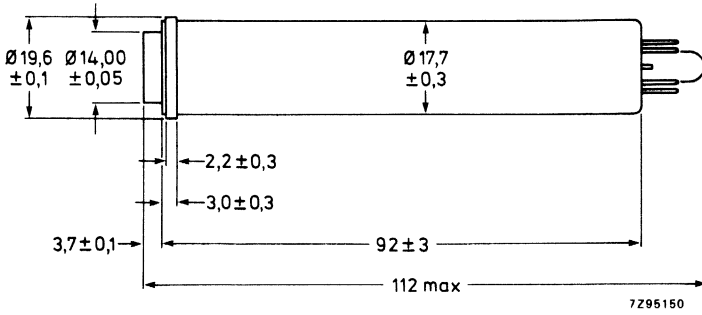

Mounting position: any

Mass:  $\approx 27 \text{ g}$

Base:

NOTES, see also General Section.

1. The tube can withstand short excursions up to 70 °C without damage or irreversible degradation in performance.
2. For short intervals. During storage the tube face shall be covered with the plastic hood provided; when the camera is idle the lens shall be capped, in stand-by also the beam will be cut-off.
3. The operating conditions and performance data quoted relate to operation in the coil unit KV4780. See relevant data of deflection/focusing assemblies.
4. The beam current  $I_b$ , as obtained by adjusting the control grid voltage (grid 1) is set at 300 nA for R and B tubes, 400 nA for black/white, and G tubes.  $I_b$  is not the total current available in the scanning beam, but is defined as the maximum amount of signal current,  $I_s$ , that can be obtained with this beam.

In the performance figures, e.g. for resolution and lag, the signal current and beam current conditions are given, e.g. as  $I_s/I_b = 20/300$  nA. This means: with a signal current of 20 nA and a beam setting which just allows a signal current of 300 nA.

N.B. The signal currents are measured with an integrating instrument connected in the signal electrode lead and a uniform illumination of the scanned area.

The peak signal currents as measured on a waveform oscilloscope will be a factor  $\alpha$  larger.

$$\alpha = \frac{100}{100-\beta}; \beta \text{ being the total blanking time in \% for the CCIR system } \alpha \text{ amounts to } 1,3).$$

5. Typical faceplate illumination level for the XQ3467 to produce 200 nA signal current will be approx. 10 lx. The signal currents stated for the colour tubes R, G and B will be obtained with an incident white light level (2856 K) on the filter of approx. 25 lx. These figures are based on the filters described in note 11. For filter BG12, however, a thickness of 1 mm is chosen.
6. Measuring conditions: illuminance level before the filter approx. 4,54 lux at a colour temperature of 2856 K and the appropriate filter inserted in the light path for the chrominance tubes.

Filters used are:

|         |             |       |           |      |
|---------|-------------|-------|-----------|------|
| XQ3467G | Schott      | VG9   | thickness | 1 mm |
| XQ3467B | Schott      | BG12  | thickness | 3 mm |
| XQ3467R | Schott      | OG570 | thickness | 3 mm |
|         | and Calflex | B1/K1 |           |      |

For transmission curves see General Section.

7. For true tonal rendition in black/white cameras and for true colorimetry in colour cameras an integral filter to eliminate response to near infrared radiation should be incorporated in the optical system.
8. As measured with a 50 mm Leitz Summicron lens having a sine response of approximately 80% at 30,3 lp/mm (400 TV lines at 6,6 mm x 8,8 mm) at  $f : 5,6$ . The horizontal amplitude response can be raised by means of suitable correction circuits, which affect neither the vertical resolution nor the limiting resolution.
9. **Build-up lag**  
After 10 s of darkness. The figures are typical percentages of the ultimate signal current obtained 60 ms and 200 ms, respectively, after the introduction of the illuminance.

**Decay lag**

After the target has been illuminated for at least 5 s. The figures represent typical signals in percentages of the original signal current 60 ms and 200 ms, respectively, after removal of the illuminance.

10. A reduction lag, especially under low key conditions is obtained when light bias up to 5 nA (peak) is applied via the optical system. Infrared light with a wavelength  $> 600$  nm in the light bias should be avoided.

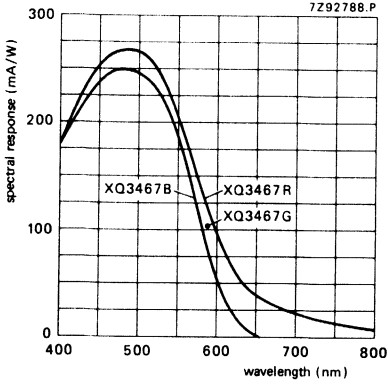

Fig. 1 Typical spectral responses.

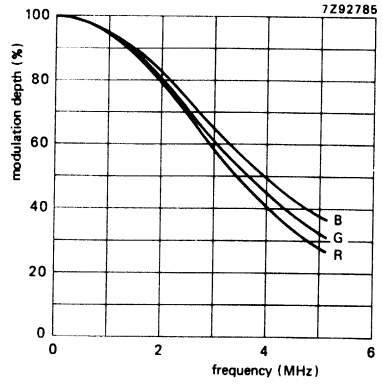

Fig. 2 Typical square wave response curves.



# DEVELOPMENT DATA

This data sheet contains advance information and specifications are subject to change without notice.

XQ4187 SERIES

## CAMERA TUBES

$\frac{2}{3}$  inch HS "Diode" Plumbicon® television camera tubes with high resolution lead-oxide photoconductive target for use in low weight high quality monochrome and colour cameras in broadcast, educational or industrial applications.

The XQ4187-series comprises the following versions:

- XQ4187 for monochrome cameras
- XQ4187R for the red channel of colour cameras
- XQ4187G for the green channel
- XQ4187B for the blue channel

Special features are:

- High stability construction (HS).
- "Diode" electron gun for D.B.C. (dynamic beam control) to minimize comet-tailing and blooming (notes 1 and 2).
- Low output capacitance, achieved by a special signal plate with contact through the window.
- Low deflection field damping by wall electrodes.
- Reduced line pick-up due to side connection of the mesh.
- Low power consumption due to electrostatic focusing.
- Low weight and small size.

### QUICK REFERENCE DATA

"Diode" electron gun

|   |               |               |         |         |                                      |
|---|---------------|---------------|---------|---------|--------------------------------------|
| Diameter  | max.          | 22 mm         |         |         |                                      |
| Length  | approx.       | 92 mm         |         |         |                                      |
| Provided with anti-halation glass disc, thickness |               | 2,5 mm        |         |         |                                      |
| Focusing  | electrostatic |               |         |         |                                      |
| Deflection  | magnetic      |               |         |         |                                      |
| Useful target area (scanning area)                |               | 6,6 x 8,8 mm  |         |         |                                      |
| Spectral response                                 |               |               |         |         |                                      |
| maximum at  | approx.       | 500 nm        |         |         |                                      |
| cut-off at  | approx.       | 650 to 850 nm |         |         |                                      |
| type  |               | XQ4187        | XQ4187R | XQ4187G | XQ4187B                              |
| Sensitivity, typical                              |               | 320           | 90      | 130     | 38 $\mu\text{A}/\text{lm}(\text{F})$ |
| Resolution at 400 TV lines (5 MHz), typical       |               | 47            | 37      | 47      | 55 %                                 |
| Heater  |               | 9 V, 55 mA    |         |         |                                      |

### OPTICAL DATA

Quality rectangle on photoconductive target  
(aspect ratio 3 : 4)

6,6 mm x 8,8 mm

Orientation of image on target

For correct orientation of the image on the target the vertical scan should be essentially parallel to the plane passing through the tube axis and the Index slot at the base. Mounted in the deflection coil, the target contact should be at the upper side during scanning.

® Registered trade mark for television camera tube.

# XQ4187 SERIES

|  |                  |
|--|------------------|
| Faceplate thickness  | $2,3 \pm 0,1$ mm |
| refractive index   | 1,52             |
| Anti-halation glass disc provided with anti-reflective coating thickness | $2,5 \pm 0,1$ mm |
| refractive index   | 1,52             |

## ACCESSORIES

Socket is integrated in the deflection coil

→ Deflection coil unit type KV4736

## ELECTRICAL DATA

### Heating

Indirect by a.c. or d.c.: parallel supply

Heater voltage  $V_f$  9 V  $\pm$  5%

→ Heater current, at  $V_f = 9,0$  V  $I_f$  nom. 55 mA

The heater voltage must never exceed 12 V r.m.s.

For optimum performance (lifetime and registration stability) stabilization of the heater voltage is recommended.

### Capacitance

Signal electrode to all (with floating indium ring)  $C_{as}$  approx. 1,6 pF

This capacitance, which is effectively the output impedance, increases when the tube is inserted in the coil unit.

**Deflection** magnetic

**Focusing** electrostatic



**LIMITING VALUES** (Absolute maximum rating system)

All voltages are referred to the cathode, unless otherwise stated.

← notes

|   |               |              |                 |   |
|---|---------------|--------------|-----------------|---|
| Signal electrode voltage                            | $V_{as}$      | max.         | 50 V            |   |
| Grid 4 voltage                                      | $V_{g4}$      | max.         | 1200 V          |   |
| Grid 3 voltage                                      | $V_{g3}$      | max.         | 500 V           |   |
| Voltage between grid 4 and grid 3                   | $V_{g4/g3}$   | max.         | 850 V           |   |
| Grid 2 voltage, focus                               | $V_{g2}$      | max.         | 75 V            |   |
| Grid 1 voltage, positive                            | $V_{g1}$      | max.         | 75 V            | 3 |
| Grid 1 voltage, negative                            | $-V_{g1}$     | max.         | 50 V            | 3 |
| Grid 1 current ( $\approx I_K$ current)             | $I_{g1}$ d.c. | max.         | 3,5 mA          |   |
| Grid 1 current (peak current with D.B.C.)           | $I_{g1p}$     | max.         | 12 mA           | 2 |
| Cathode to heater voltage, positive peak            | $V_{kfp}$     | max.         | 50 V            |   |
| Cathode to heater voltage, negative peak            | $-V_{kfp}$    | max.         | 50 V            | 3 |
| Cathode heating time before drawing cathode current | $t_h$         | min.         | 1 min           |   |
| Ambient temperature, storage and operation          | $T_{amb}$     | max.<br>min. | 50 °C<br>-30 °C | 7 |
| Faceplate temperature, storage and operation        | T             | max.<br>min. | 50 °C<br>-30 °C |   |
| Faceplate illuminance (intermittent)                | E             | max.         | 100 lx          | 8 |

DEVELOPMENT DATA

## OPERATING CONDITIONS AND PERFORMANCE

for a scanned area of 6,6 mm x 8,8 mm

notes

6

### Conditions

|  |              |                |   |
|--|--------------|----------------|---|
| Cathode voltage  | $V_k$        | 0 V            |   |
| Signal electrode voltage                                   | $V_{as}$     | 45 V           |   |
| Beam current   | $I_b$        |                | 7 |
| Grid 4 voltage   | $V_{g4}$     | 1100 V         |   |
| Grid 3 voltage   | $V_{g3}$     | 400 V          |   |
| Grid 2 voltage, focus                                      | $V_{g2}$     | 44 V $\pm$ 3 V |   |
| Grid 1 voltage   | $V_{g1}$     |                | 7 |
| Blanking voltage on grid 1, peak to peak<br>without D.B.C. | $V_{g1}$ p-p | 50 V           |   |
| Faceplate illuminance                                      | E            | 0 to 10 lx     | 8 |
| Faceplate temperature                                      | T            | 20 to 45 °C    |   |

### Electron gun characteristics

#### Cut-off

Grid 1 voltage for cut-off without blanking  
Grid 1 voltage for 400 nA beam current

|           |            |
|-----------|------------|
| $V_{g1}$  | -5 to 0 V  |
| $V_{g1w}$ | 10 to 20 V |

Blanking voltage, peak to peak  
on grid 1, without D.B.C.

|              |      |   |
|--------------|------|---|
| $V_{g1}$ p-p | 50 V | 3 |
|--------------|------|---|

Grid currents at  
grid 1  
grid 3  
grid 4

|          |          |             |
|----------|----------|-------------|
| $I_b$    | 400 nA   | max. D.B.C. |
| $I_{g1}$ | max. 3   | 10 mA       |
| $I_{g3}$ | max. 100 | 200 $\mu$ A |
| $I_{g4}$ | max. 4   | 10 $\mu$ A  |

### Performance

Dark current

|       |        |      |
|-------|--------|------|
| $I_d$ | $\leq$ | 2 nA |
|-------|--------|------|

Sensitivity at colour temperature of illuminance = 2856 K

XQ4187

XQ4187R

XQ4187G

XQ4187B

|      |     |                      |   |
|------|-----|----------------------|---|
|      |     |                      | 9 |
| min. | 275 | typ. 320 $\mu$ A/lm  |   |
| min. | 75  | typ. 90 $\mu$ A/lmF  |   |
| min. | 105 | typ. 130 $\mu$ A/lmF |   |
| min. | 35  | typ. 38 $\mu$ A/lmF  |   |

Gamma of transfer characteristic

0,95 + 0,05

Spectral response:

max. response at  
cut-off XQ4187R  
cut-off XQ4187  
cut-off XQ4187B, XQ4187G  
response curves

|           |               |    |
|-----------|---------------|----|
| $\approx$ | 500 nm        | 10 |
| $\approx$ | 850 nm        |    |
| $\approx$ | 650 to 850 nm |    |
| $\approx$ | 650 nm        |    |
|           | see Fig. 1    |    |

Resolution

notes

Modulation depth, i.e. uncompensated amplitude response at 400 TV lines (5 MHz) at the centre of the picture.

11

|  |       | XQ4187 | XQ4187R | XQ4187G | XQ4187B |
|--|-------|--------|---------|---------|---------|
| Signal current                           | $I_s$ | 200    | 150 nA  | 200 nA  | 150 nA  |
| Beam current                             | $I_b$ | 400    | 300 nA  | 400 nA  | 300 nA  |
| Modulation depth at 400 TV lines (5 MHz) | typ.  | 47     | 37 %    | 47 %    | 55 %    |
|  | min.  | 40     | 32 %    | 40 %    | 50 %    |

Modulation transfer characteristics

see Fig. 2

Lag (typical values, no light bias applied)

12, 13

Light source with a colour temperature of 2856 K  
Appropriate filter inserted in light path

Low key conditions

|           | build-up lag          |        | decay lag             |        |
|-----------|-----------------------|--------|-----------------------|--------|
|           | $I_s/I_b = 20/300$ nA |        | $I_s/I_b = 20/300$ nA |        |
|           | 60 ms                 | 200 ms | 60 ms                 | 200 ms |
| XQ4187, G | 95%                   | ≈ 100% | 6%                    | 2%     |
| XQ4187R   | 95%                   | ≈ 100% | 7%                    | 2,5%   |
| XQ4187B   | 95%                   | ≈ 100% | 7%                    | 3%     |

DEVELOPMENT DATA

Highlight handling capability with D.B.C.

14

# XQ4187 SERIES

## MECHANICAL DATA

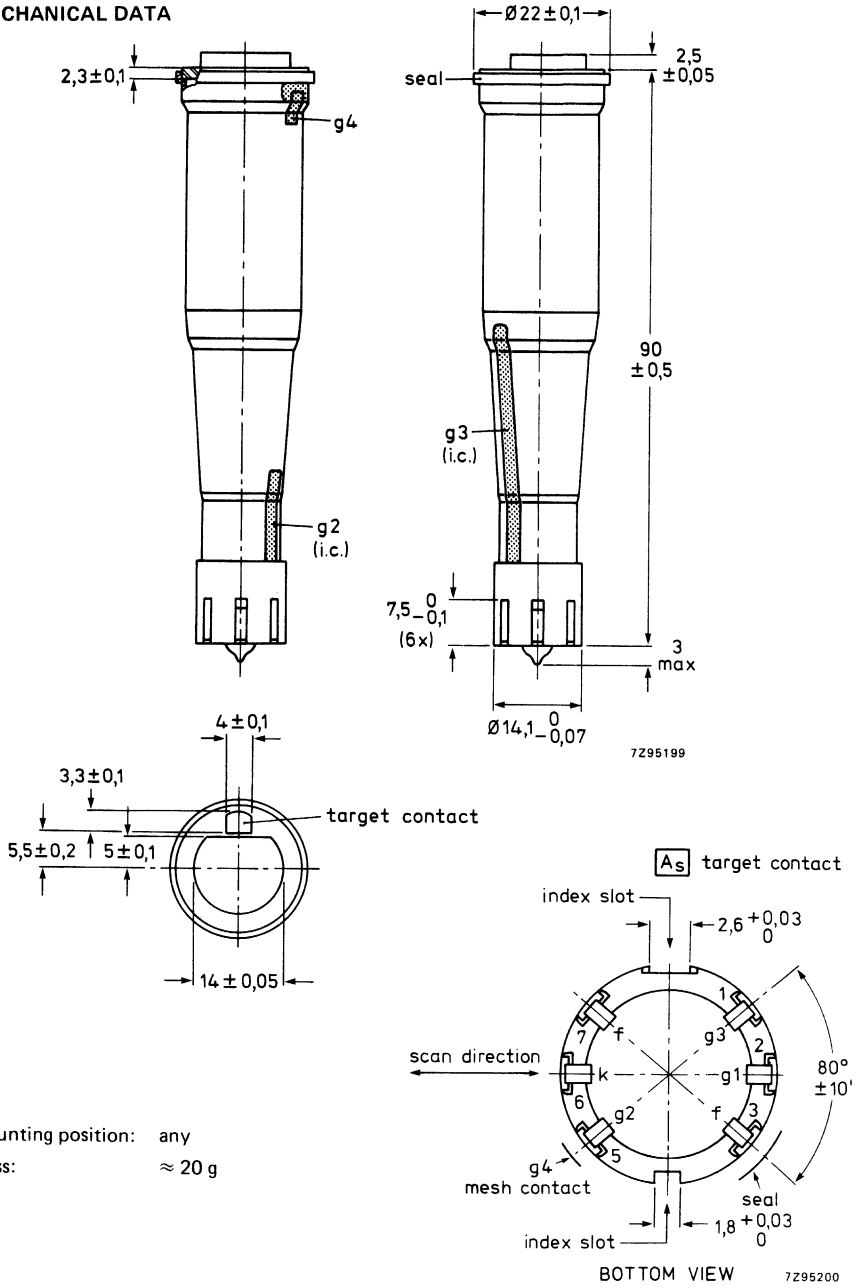

Mounting position: any  
 Mass:  $\approx 20$  g

**NOTES**, see also General Section.

1. Avoid continuous operation at high beam currents since this will shorten tube life. Full advantage of the high beam reserve to reduce comet-tailing and blooming can be made with DBC circuitry which, during highlights, feeds positive-going pulses derived from the video signal to grid 1, to increase the beam current momentarily.
2. The "diode" gun operates with a positive ( $\leq 30$  V) grid 1 voltage adjusted for correct beam settings, see note 7.  
The DBC circuitry should, in the case of highlights, supply positive-going pulses with a maximum of 50 V to grid 1 above the normal  $V_{g1}$  setting for  $I_b = 400$  nA.  
N.B. Applying higher pulses than 50 V is not recommended since this will shorten tube life, impair resolution and may introduce oscillations.
3. The following circuitry and tube settings are recommended.

DEVELOPMENT DATA

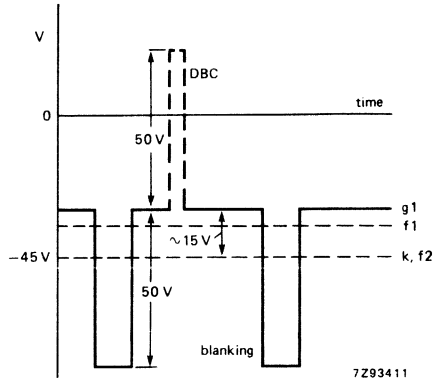
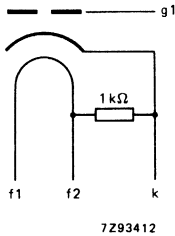

4. The tube can withstand short excursions up to 70 °C without damage or irreversible degradation in performance.
5. During storage the tube face shall be covered with the plastic hood provided; when the camera is idle the lens shall be capped, in stand-by also the beam will be cut-off.
6. The operating conditions and performance data quoted relate to operation in the coil unit KV4736. See relevant data of deflection/focusing assemblies.
7. The beam current  $I_b$ , as obtained by adjusting the control grid (grid 1) voltage is set to 300 nA for R and B tubes, 400 nA for black and white and G tubes.  $I_b$  is not the actual current available in the scanning beam, but is defined as the maximum amount of signal current,  $I_s$ , that can be obtained with this beam.

In the performance figures for lag, the signal current and beam current conditions are given, e.g. as  $I_s/I_b = 20/300$  nA. This means: with a signal current of 20 nA and a beam setting which just allows a signal current of 300 nA.

N.B. The signal currents are measured with an integrating instrument connected in the signal electrode lead and a uniform illumination of the scanned area. The peak signal currents as measured on a waveform oscilloscope will be a factor  $\alpha$  larger.

$$\alpha = \frac{100}{100 - \beta}; \beta \text{ being the total blanking time in \%}; \text{ for the CCIR system } \alpha = 1,3.$$

## NOTES (continued)

8. Typical faceplate illumination level for the XQ4187 to produce 200 nA signal current will be approx. 10 lx. The signal currents stated for the colour tubes R, G and B will be obtained with an incident white light level (2856 K) on the filter of approx. 25 lx. These figures are based on the filters described in note 9. For filter BG12, however, a thickness of 1 mm is chosen.
9. Measuring conditions.  
Illuminance level 4,54 lx at a colour temperature of 2856 K. Filters are inserted in the light path for the chrominance tubes.  
Filters used are:  
XQ4187R: B1/K1 and Schott OG570, thickness 3 mm.  
XQ4187G: Schott VG9, thickness 1 mm.  
XQ4187B: Schott BG12, thickness 3 mm.  
For transmission curves see General Section.
10. For true tonal rendition in black/white cameras, and for true colorimetry in colour cameras, an integral filter to eliminate response to near infrared radiation should be incorporated in the optical system, together with an integral B1/K1 filter or equivalent.
11. As measured with a 50 mm Leitz Summicron lens having a sine response of approx. 80% at 30 lp/mm (400 TV lines at 6,6 mm x 8,8 mm) at  $f : 5,6$ .  
The horizontal amplitude response can be raised by means of suitable correction circuits, which affect neither the vertical resolution nor the limiting resolution.
12. Build-up lag.  
After 10 s of darkness. The figures are typical percentages of the ultimate signal current obtained 60 ms or 200 ms, respectively, after introduction of the illuminance.  
Decay lag.  
After the target has been illuminated for at least 5 s. The figures represent typical signal in percentages of the original signal current 60 ms or 200 ms, respectively, after removal of the illuminance.
13. A reduction of lag, especially under low key conditions, is to be obtained when light bias up to 5 nA<sub>p</sub> is applied via the optical system. Infrared light with a wavelength > 600 nm in the light bias should be avoided.
14. With D.B.C. applied (see notes 2 and 3) the tube will properly handle highlights with a diameter of 10% of the picture height and with a brightness corresponding to 8 times the brightness for normal peak signal. The maximum peak signal currents in the case of highlights will be 1400 nA. Video amplifiers should be designed to accommodate these.

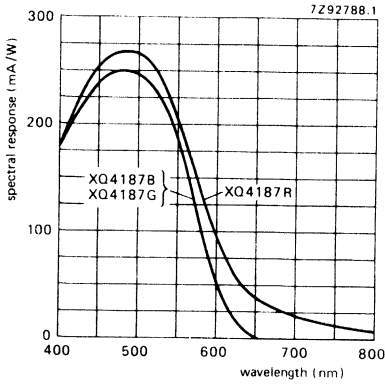

Fig. 1 Typical spectral responses.

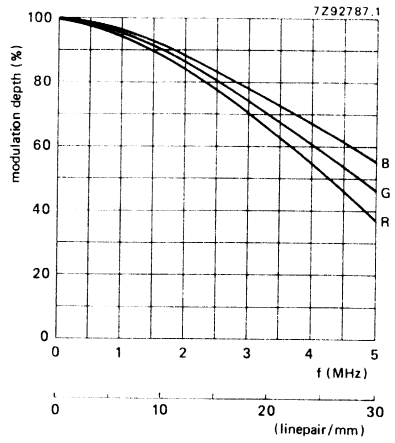

Fig. 2 Typical square wave response curves.

DEVELOPMENT DATA





14 mm dia. PLUMBICON TUBES



## CAMERA TUBES

14 mm (½ inch) HS "Diode" Plumbicon® television camera tubes with high resolution lead-oxide photoconductive target for use in low weight high quality colour cameras in broadcast, educational or industrial applications.

The XQ4087 series comprises the following versions:

- XQ4087R for the red channel of colour cameras
- XQ4087G for the green channel
- XQ4087B for the blue channel

Special features are:

- High stability construction (HS).
- "Diode" electron gun for D.B.C. (dynamic beam control) to minimize comet-tailing and blooming (notes 1 and 2).
- Low output capacitance, achieved by a special signal plate with contact through the window.
- Low deflection field damping by wall electrodes.
- Reduced line pick-up due to side connection of the mesh.
- Low power consumption due to electrostatic focusing.
- Low weight and small size.

### QUICK REFERENCE DATA

|   |         |                 |               |        |
|---|---------|-----------------|---------------|--------|
| "Diode" electron gun                              |         |                 |               |        |
| Diameter  |         | max.            | 18 mm         |        |
| Length  |         | approx.         | 73 mm         |        |
| Provided with anti-halation glass disc, thickness |         |                 | 3 mm          |        |
| Focusing  |         | electrostatic   |               |        |
| Deflection  |         | magnetic        |               |        |
| Useful target area (scanning area)                |         | 4,8 mm x 6,4 mm |               |        |
| Spectral response                                 |         |                 |               |        |
| max. at   |         | approx.         | 500 nm        |        |
| cut-off at  |         | approx.         | 650 to 850 nm |        |
| type  | XQ4087R | XQ4087G         | XQ4087B       |        |
| Sensitivity, typ.                                 | 85      | 100             | 25            | µA/lmF |
| Resolution at 320 TV lines (4 MHz)                | 40      | 45              | 50            | %      |
| Heater  |         |                 | 9 V, 55 mA    |        |

### OPTICAL DATA

Quality rectangle on photoconductive target  
(aspect ratio 3 : 4)

4,8 mm x 6,4 mm

Orientation of image on target

For correct orientation of the image on the target the vertical scan should be essentially parallel to the plane passing through the tube axis and the index slot at the base. Mounted in the deflection coil, the target contact should be at the upper side during scanning.

® Registered trade mark for television camera tubes.

# XQ4087 SERIES

|  |                  |
|--|------------------|
| Faceplate thickness                                | $1,6 \pm 0,1$ mm |
| refractive index                                   | 1,51             |
| Anti-halation glass disc with AR-coating thickness | $3 \pm 0,1$ mm   |
| refractive index                                   | 1,51             |

## ACCESSORIES

Socket is integrated in the deflection coil.

Deflection coil unit type AT1120

## ELECTRICAL DATA

### Heating

Indirect by a.c. or d.c.; parallel supply

Heater voltage  $V_f$  9 V  $\pm$  5%

Heater current, at  $V_f = 9,0$  V  $I_f$  nom. 55 mA

The heater voltage must never exceed 12 V r.m.s. For optimum performance (lifetime and registration stability) stabilization of the heater voltage is recommended.

### Capacitance

Signal electrode to all  $C_{as}$  approx. 1,7 pF

This capacitance, which is effectively the output impedance, increases when the tube is inserted in the coil unit.

**Deflection** magnetic

**Focusing** electrostatic

**LIMITING VALUES** (Absolute maximum rating system)

All voltages are referred to the cathode, unless otherwise stated.

|  |             |      |        | notes |
|--|-------------|------|--------|-------|
| Signal electrode voltage                             | $V_{as}$    | max. | 30 V   |       |
| Grid 4 voltage                                       | $V_{g4}$    | max. | 850 V  |       |
| Grid 3 voltage                                       | $V_{g3}$    | max. | 350 V  |       |
| Voltage between grid 4 and grid 3                    | $V_{g4/g3}$ | max. | 600 V  |       |
| Grid 2 voltage, focus                                | $V_{g2}$    | max. | 50 V   |       |
| Grid 1 voltage, positive                             | $V_{g1}$    | max. | 80 V   |       |
| Grid 1 voltage, negative                             | $-V_{g1}$   | max. | 50 V   |       |
| Grid 1 current ( $\approx I_K$ current), with D.B.C. | $I_{g1dc}$  | max. | 5 mA   |       |
| Grid 1 current (peak current with D.B.C.)            | $I_{g1p}$   | max. | 12 mA  |       |
| Cathode to heater voltage, positive peak             | $V_{kfp}$   | max. | 50 V   |       |
| Cathode to heater voltage, negative peak             | $-V_{kfp}$  | max. | 50 V   | 3     |
| Cathode heating time before drawing cathode current  | $t_h$       | min. | 1 min  |       |
| Ambient temperature, storage and operation           | $T_{amb}$   | max. | 50 °C  |       |
|  |             | min. | -30 °C |       |
| Faceplate temperature, storage and operation         | $T$         | max. | 50 °C  | 4     |
|  |             | min. | -30 °C |       |
| Faceplate illuminance (intermittent)                 | $E$         | max. | 100 lx | 5     |

## OPERATING CONDITIONS AND PERFORMANCE

for a scanned area of 4,8 mm x 6,4 mm

notes

6

### Conditions

|  |                      |              |   |
|--|----------------------|--------------|---|
| Cathode voltage  | $V_k$                | 0 V          |   |
| Signal electrode voltage                                   | $V_{as}$             | 25 V         |   |
| Beam current   | $I_b$                |              | 7 |
| Grid 4 voltage   | $V_{g4}$             | 750 V        |   |
| Grid 3 voltage   | $V_{g3}$             | 250 V        |   |
| Grid 2 voltage, focus                                      | $V_{g2}$             | $30 \pm 3$ V |   |
| Grid 1 voltage   | $V_{g1}$             |              | 7 |
| Blanking voltage on grid 1, peak to peak<br>without D.B.C. | $V_{g1 \text{ p-p}}$ | 30 V         |   |
| Faceplate illuminance                                      | E                    | 0 to 10 lx   | 8 |
| Faceplate temperature                                      | T                    | 20 to 45 °C  |   |

### Electron gun characteristics

#### Cut-off

|   |           |             |   |
|---|-----------|-------------|---|
| Grid 1 voltage for cut-off without blanking | $V_{g1}$  | -5 to 0 V   |   |
| Grid 1 voltage for 200 nA beam current      | $V_{g1w}$ | $\leq 25$ V | 7 |

#### Blanking voltage, peak to peak

|                           |                      |      |  |
|---------------------------|----------------------|------|--|
| on grid 1, without D.B.C. | $V_{g1 \text{ p-p}}$ | 30 V |  |
| on cathode                | $V_k \text{ p-p}$    | 30 V |  |

#### Grid currents at

|        |          |               |    |                    |  |
|--------|----------|---------------|----|--------------------|--|
|        | $I_b$    | <u>200 nA</u> |    | <u>max. D.B.C.</u> |  |
| grid 1 | $I_{g1}$ | max. 3,5      | 12 | mA                 |  |
| grid 3 | $I_{g3}$ | max. 10       | 40 | $\mu\text{A}$      |  |
| grid 4 | $I_{g4}$ | max. 1        | 4  | $\mu\text{A}$      |  |

### Performance

|              |       |               |
|--------------|-------|---------------|
| Dark current | $I_d$ | $\leq 1,0$ nA |
|--------------|-------|---------------|

#### Sensitivity at colour temperature of illuminance = 2856 K

|         |      |    |      |     |                          |   |
|---------|------|----|------|-----|--------------------------|---|
| XQ4087R | min. | 65 | typ. | 85  | $\mu\text{A}/\text{lmF}$ | 9 |
| XQ4087G | min. | 75 | typ. | 100 | $\mu\text{A}/\text{lmF}$ |   |
| XQ4087B | min. | 22 | typ. | 25  | $\mu\text{A}/\text{lmF}$ |   |

#### Gamma of transfer characteristic

0,95 + 0,05

#### Spectral response:

|                  |           |               |    |
|------------------|-----------|---------------|----|
| max. response at | $\approx$ | 500 nm        | 10 |
| cut-off XQ4087R  | $\approx$ | 850 nm        |    |
| cut-off XQ4087G  | $\approx$ | 650 to 850 nm |    |
| cut-off XQ4087B  | $\approx$ | 650 nm        |    |

#### response curves

see Fig. 1

Resolution

Modulation depth, i.e. uncompensated amplitude response at 320 TV lines (4 MHz) at the centre of the picture.

notes

11

|   |       | XQ4087R | XQ4087G | XQ4087B |
|---|-------|---------|---------|---------|
| Signal current                              | $I_s$ | 50 nA   | 100 nA  | 50 nA   |
| Beam current                                | $I_b$ | 100 nA  | 200 nA  | 100 nA  |
| Modulation depth at<br>320 TV lines (4 MHz) | typ.  | 40 %    | 45 %    | 50 %    |
|   | min.  | 30 %    | 35 %    | 40 %    |

Modulation transfer characteristics

see Fig. 2

Lag (typical values, no light bias applied)

12, 13

Light source with a colour temperature of 2856 K  
Appropriate filter inserted in light path

Low key conditions

|         | build-up lag          |        | decay lag             |        |
|---------|-----------------------|--------|-----------------------|--------|
|         | $I_s/I_b = 20/300$ nA |        | $I_s/I_b = 20/300$ nA |        |
|         | 60 ms                 | 200 ms | 60 ms                 | 200 ms |
| XQ4087G | 95                    | ~ 100  | 8,0                   | 3,0    |
| XQ4087R | 95                    | ~ 100  | 8,0                   | 3,0    |
| XQ4087B | 95                    | ~ 100  | 9,0                   | 3,5    |

Highlight handling capability with D.B.C.

14

# XQ4087 SERIES

## MECHANICAL DATA

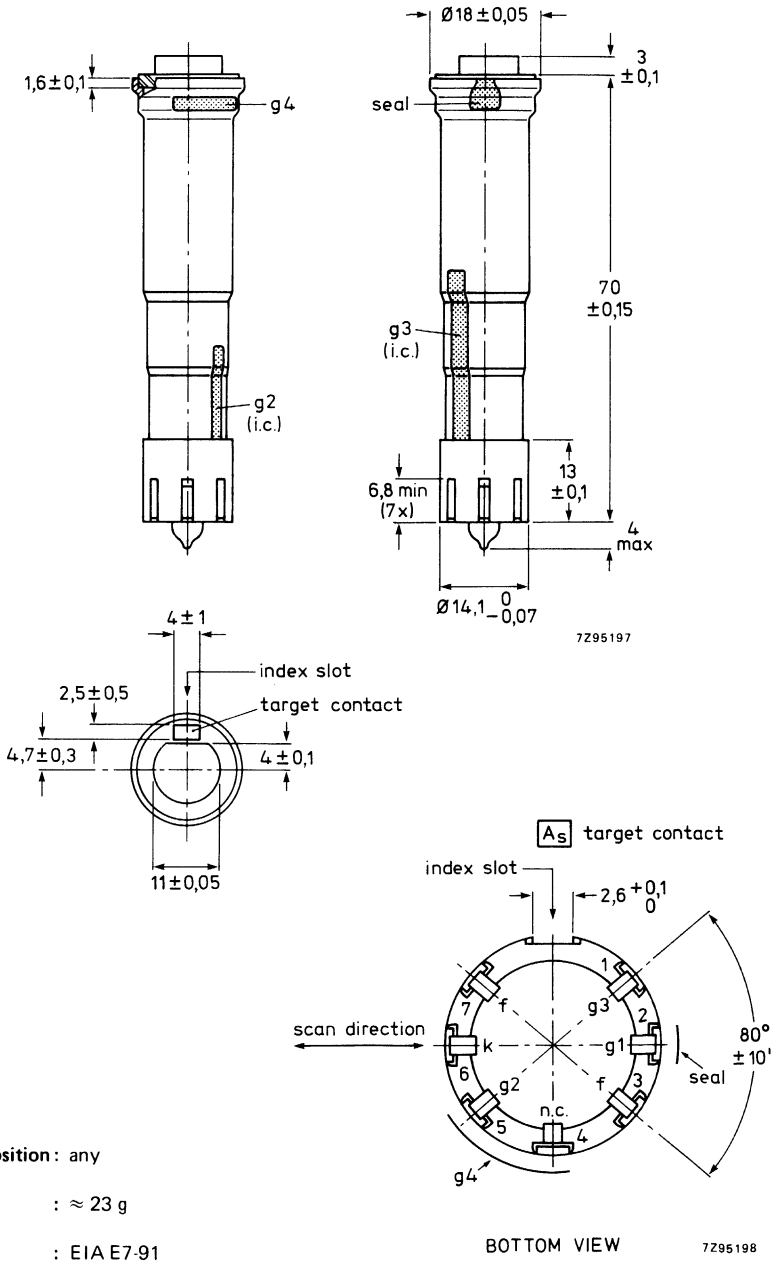

Mounting position : any

Mass :  $\approx 23$  g

Base : EIA E7-91

BOTTOM VIEW

7295198



NOTES, see also General Section.

1. Avoid continuous operation at high beam currents since this will shorten tube life. Full advantage of the high beam reserve to reduce comet-tailing and blooming can be made with D.B.C. circuitry which, during highlights, feeds positive-going pulses derived from the video signal to grid 1 to increase the beam current momentarily.
2. The diode gun operates with a positive ( $\leq 25$  V) grid 1 voltage adjusted for correct beam currents, see note 7. The D.B.C. circuitry should, in the case of highlights, supply positive-going pulses with a maximum of 30 V to grid 1 above the normal  $V_{g1}$  setting for  $I_b = 200$  nA.  
N.B. Applying higher pulses than 30 V peak is not recommended since this will shorten the tube life, impair resolution and may cause oscillations.
3. The resistance of the external circuitry between K and F should be at least  $1000 \Omega$  when  $V_f$  is positive with respect to  $V_k$ .
4. Short temperature excursions up to  $70^\circ\text{C}$  during operation are allowed.
5. During storage cover the tube face with the plastic hood provided; when the camera is idle cap the lens. In stand-by also the beam will be cut-off.
6. The operating conditions and performance quoted relate to operation in the coil unit AT1120. See relevant data of deflection/focusing assemblies.
7. The beam current  $I_b$ , as obtained by adjusting the control grid voltage (grid 1) is set at 100 nA for R and B tubes, 200 nA for G tubes.  $I_b$  is not the total current available in the scanning beam, but is defined as the maximum amount of signal current,  $I_s$ , that can be obtained with this beam. In the performance figures for lag, the signal current and beam current conditions are given, e.g. as  $I_s/I_b = 20/300$  nA. This means: with a signal current of 20 nA and a beam setting which just allows a signal current of 300 nA.  
N.B. The signal currents are measured with an integrating instrument connected in the signal electrode lead and a uniform illumination of the scanned area.  
The peak signal currents as measured on a waveform oscilloscope will be a factor  $\alpha$  larger.  
$$\alpha = \frac{100}{100 - \beta}; \quad \beta \text{ being the total blanking time in \%: for the CCIR system } \alpha = 1,3.$$
8. Typical faceplate illumination level for the XQ4087 to produce 100 nA signal current will be approx. 12 lx. The signal currents stated for the colour tubes R, G and B will be obtained with an incident white light level (2856 K) on the filter of approx. 25 lx. These figures are based on the filters described in note 9. For filter BG12, however, a thickness of 1 mm is chosen.
9. Measuring conditions.  
Illuminance level 4,54 lx at a colour temperature of 2856 K. Filters are inserted in the light path for the chrominance tubes.  
Filters used for  
XQ4087R: B1/K1 and Schott OG570, thickness 3 mm.  
XQ4087G: B1/K1 and Schott VG9, thickness 1 mm.  
XQ4087B: B1/K1 and Schott BG12, thickness 3 mm.  
For transmission curves see General Section.

**NOTES, continued**

10. For true tonal rendition in black/white cameras, and for true colorimetry in colour cameras, an integral filter to eliminate response to near infrared radiation should be incorporated in the optical system, together with an integral B1/K1 filter or equivalent.
11. As measured with 50 mm Leitz Summicron lens having a sine response of approx. 80% at 32,5 lp/mm (320 TV lines at 4,8 mm x 6,4 mm) at  $f : 5,6$ .  
The horizontal amplitude response can be raised by means of suitable correction circuits, which affect neither the vertical resolution nor the limiting resolution.
12. Build-up lag.  
After 10 s of darkness. The figures are typical percentages of the ultimate signal current obtained 60 ms or 200 ms, respectively, after introduction of the illuminance.  
Decay lag.  
After the target has been illuminated for at least 5 s. The figures represent typical signals in percentages of the original signal current 60 ms or 200 ms, respectively, after removal of the illuminance.
13. A reduction of lag, especially under low key conditions, is to be obtained when light bias is applied via the optical system. Infrared light with a wavelength  $> 600$  nm in the light bias should be avoided.
14. With D.B.C. applied (see note 2) the tube will properly handle highlights with a diameter of 10% of the picture height and with a brightness corresponding to 8 times the brightness for normal peak signal. The maximum peak signal currents in the case of highlights will be 800 nA. Video amplifiers should be designed to accommodate these.

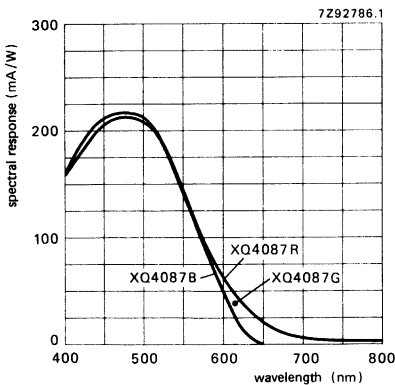

Fig. 1 Typical spectral responses.

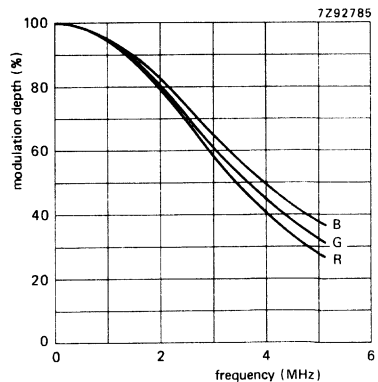

Fig. 2 Typical square wave response curves.

## DEFLECTION AND FOCUSING ASSEMBLIES

SURVEY

| tube diameter  | type number and cat. number  | triplet or single | inductance mH |             | resistance $\Omega$ |             |             | current mA |           |            | remarks                           |
|----------------|------------------------------|-------------------|---------------|-------------|---------------------|-------------|-------------|------------|-----------|------------|-----------------------------------|
|                |                              |                   | line coils    | frame coils | line coils          | frame coils | focus coils | p-p line   | p-p frame | d.c. focus |                                   |
| 30 mm (1 1/4") | AT1130T<br>3122 137 18880    | T                 | 0,84          | 5,5         | 2,1                 | 14,5        | 1125        | 180        | 55        | 35         | rear loading + alignment coils    |
|                | AT1130S<br>3122 137 18890    | S                 | 0,84          | 5,5         | 2,1                 | 14,5        | 1125        | 180        | 55        | 35         | rear loading + alignment coils    |
| 25 mm (1")     | AT1115/01<br>3122 137 12710  | T                 | 0,79          | 26          | 2,2                 | 62          | 1718        | 260        | 36        | 32         | rear loading + alignment coils    |
|                | AT1119/01<br>3122 137 12700  | S                 | 0,79          | 26          | 2,2                 | 62          | 1718        | 260        | 36        | 32         | rear loading + alignment coils    |
|                | AT1116/06<br>3122 137 15040  | T                 | 0,79          | 28          | 2,2                 | 62          | 140         | 280        | 34        | 108        | front loading + alignment coils   |
|                | AT1116S<br>3122 137 15050    | S                 | 0,79          | 28          | 2,2                 | 62          | 140         | 280        | 34        | 108        | front loading + alignment coils   |
|                | AT1126T<br>3122 137 19060    | T                 | 0,8           | 4,4         | 2,2                 | 10          | 1300        | 230        | 80        | 30         | rear loading + alignment coils    |
|                | AT1126S<br>3122 137 19050    | S                 | 0,8           | 4,4         | 2,2                 | 10          | 1300        | 230        | 80        | 30         | rear loading + alignment coils    |
| 18 mm (2/3")   | AT1109/01<br>3122 137 18280  | T                 | 0,91          | 2,8         | 3,8                 | 12,7        | 60          | 260        | 114       | 120        | rear loading + alignment rings    |
|                | AT1109/01S<br>3122 137 18290 | S                 | 0,91          | 2,8         | 3,8                 | 12,7        | 60          | 260        | 114       | 120        | rear loading + alignment rings    |
|                | AT1109/10<br>3122 137 18730  | T                 | 0,91          | 2,8         | 3,8                 | 12,7        | 60          | 230        | 104       | 115        | for L.O.C. tubes, alignment rings |

|                              |   |       |      |      |      |      |     |     |     |                                    |
|------------------------------|---|-------|------|------|------|------|-----|-----|-----|------------------------------------|
| AT1109/16S<br>8222 034 80190 | S | 0,91  | 2,8  | 3,8  | 12,7 | 60   | 230 | 104 | 115 | for L.O.C. tubes, alignment rings  |
| AT1109/16T<br>8222 034 80160 | T | 0,91  | 2,8  | 3,8  | 12,7 | 60   | 230 | 104 | 115 | for L.O.C. tubes, alignment rings  |
| KV4722<br>9390 304 60000     | S | —     | —    | —    | —    | 22,7 | —   | —   | 201 | for M.S. tubes                     |
| KV4736-3AS<br>9390 304 80000 | S | 1,15  | 2,41 | 4,5  | 24   | —    | 185 | 95  | —   | for H.S. tubes                     |
| KV4736-3AT<br>9390 304 90000 | T | 1,15  | 2,41 | 4    | 24,8 | —    | 185 | 95  | —   | for H.S. tubes                     |
| KV4780<br>9390 304 70000     | S | 1,17  | 5,3  | 5,03 | 33   | —    | 75  | 30  | —   | for tubes with electrostatic focus |
| AT1120S<br>3122 137 18870    | S | 0,325 | 1,1  | 6,2  | 14,1 | —    | 90  | 92  | —   | for H.S. tubes                     |
| AT1120T                      | T | 0,325 | 1,1  | 6,2  | 14,1 | —    | 190 | 92  | —   | for H.S. tubes                     |
| 14 mm<br>(½")                |   |       |      |      |      |      |     |     |     |                                    |



## DEFLECTION UNITS FOR 2/3-INCH PLUMBICON TUBE

### QUICK REFERENCE DATA

|                        | inductance | resistance    |
|------------------------|------------|---------------|
| Line deflection coils  | 0,91 mH    | 3,8 $\Omega$  |
| Frame deflection coils | 2,8 mH     | 12,7 $\Omega$ |
| Focus coil             |            | 60 $\Omega$   |

### APPLICATION

The AT1109/01 is a triplet of rear-loaded deflection units for use in colour television cameras using 2/3 inch pick-up tubes e.g. Plumbicon® tubes, types XQ1427 and XQ2427.

Their small dimensions and low weight make them specially suitable for use in portable ENG cameras.

### DESCRIPTION

The deflection units contain the deflection and focus coils and are provided with permanent magnet alignment rings. The effective alignment field intensities and directions can be adjusted, the minimum field strength position is indicated. The focus coil is situated inside the deflection coils, hence the focus power is reduced.

The housing consists of a mu-metal can for optimum screening from external magnetic fields and to form the required magnetic circuit for the deflection fields.

The camera tubes are secured in position by an aluminium nut-ring at the rear of the units and by means of a nylon glass tube.

The target contact can be removed and replaced by a contact of own design, e.g. incorporating a video preamplifier.

### Warning

No deformation of the calibrated mu-metal housing is allowed as this will strongly influence the performance and adjustments of the units.

### Catalogue number

The catalogue number of the triplet is 3122 137 18280.

The catalogue number of a single unit, AT1109/01S, is 3122 137 18290.

MECHANICAL DATA

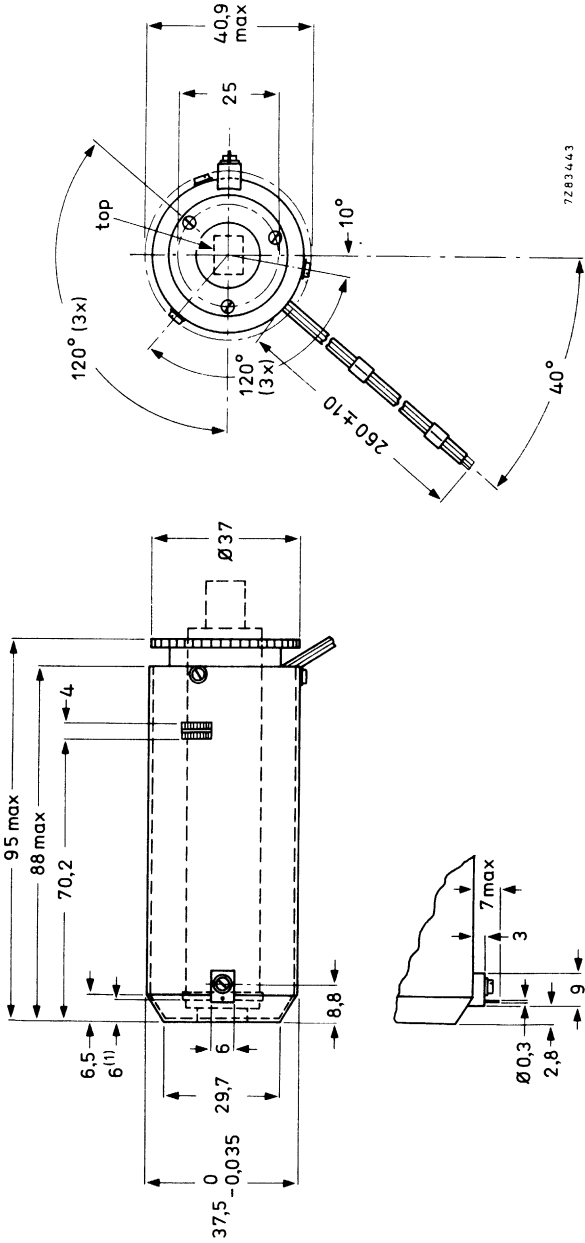

Mass per unit 230 g  
 Operating body temperature range -15 to +65 °C  
 (1) Nominal distance tube target to front unit.

Fig. 1.



ELECTRICAL DATA (typical values)

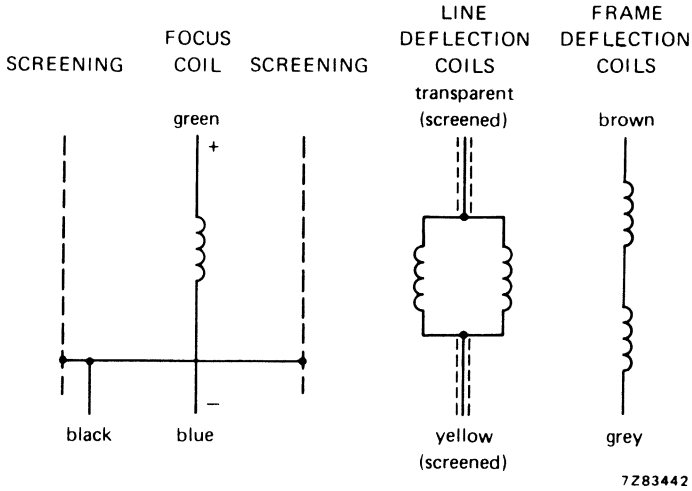

Fig. 2.

| coils                  | inductance<br>mH | resistance<br>$\Omega$ | current<br>mA       | connections         |
|------------------------|------------------|------------------------|---------------------|---------------------|
| Line deflection coils  | $0,91 \pm 5\%$   | $3,8 \pm 10\%$         | $260 \pm 5\%$ (p-p) | transparent; yellow |
| Frame deflection coils | $2,8 \pm 5\%$    | $12,7 \pm 10\%$        | $114 \pm 5\%$ (p-p) | brown; grey         |
| Focus coil*            |                  | $60 \pm 10\%$          | $120 \pm 5\%$       | green; blue         |

\* Polarity: the north-seeking pole of a compass should be attracted to the image end of the unit.

**Requirements for normal operation (XQ1427; XQ2427)**

|                                  |              |      |          |                                     |
|----------------------------------|--------------|------|----------|-------------------------------------|
| Tube setting                     | $V_{g2}$     | =    | 300 V    | } with respect to cathode potential |
|                                  | $V_{g3}$     | =    | 430 V    |                                     |
|                                  | $V_{g4}^*$   | =    | 750 V    |                                     |
|                                  | $V_{target}$ | =    | 45 V     |                                     |
| signal current                   | $I_s$        | =    | 150 nA   |                                     |
| beam current                     | $I_b$        | =    | 300 nA   |                                     |
| Alignment magnet field intensity |              | max. | 0,24 mT  |                                     |
|                                  |              | min. | 0,015 mT |                                     |

**Geometric distortion**

Ambient temperature 21 °C.

Measured at operating temperature.

|                        |      |                        |  |
|------------------------|------|------------------------|--|
| <b>Distortion</b>      |      |                        |  |
| inside circle diam. H  | max. | 0,5% of picture height |  |
| outside circle diam. H | max. | 1% of picture height   |  |
| Skew error             | max. | 1% of picture height   |  |

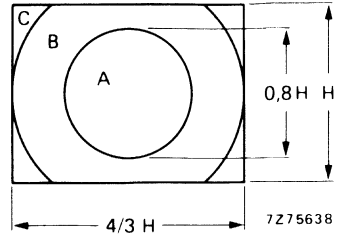

Fig. 3.

Nominal scanning area: 6,6 mm x 8,8 mm  
(H = 6,6 mm)

**Registration**

The misregistration in any triplet (measured after skew correction) is not greater than:

- 30 ns in zone A
- 60 ns in zone B
- 120 ns in zone C

The errors are measured both in horizontal and vertical direction and are expressed in units of 1/52000 of an active scan duration which is equivalent (horizontally) to 1 ns for CCIR corresponding to approximately 0,00256% ( $25 \times 10^{-6}$ ) related to picture height.

**Capacitance of tube target (XQ1427; XQ2427)**

The capacitance between the target and the electrodes increases less than 3 pF when the tube is inserted into the deflection unit.

\*  $V_{g4}$  to be adjusted for minimum beam landing error to compensate for tube tolerances.

## DEFLECTION UNITS FOR 2/3-INCH PLUMBICON TUBE

with low output capacitance

### QUICK REFERENCE DATA

|                        | inductance | resistance    |
|------------------------|------------|---------------|
| Line deflection coils  | 0,91 mH    | 3,8 $\Omega$  |
| Frame deflection coils | 2,8 mH     | 12,7 $\Omega$ |
| Focus coil             |            | 60 $\Omega$   |

### APPLICATION

The AT1109/10 is a triplet of rear-loaded deflection units for use in colour television cameras using 2/3 inch pick-up tubes e.g. Plumbicon® tubes, type XQ3427, with low output capacitance (LOC). Their small dimensions and low weight make them specially suitable for use in portable ENG cameras.

### DESCRIPTION

The deflection units contain the deflection and focus coils and are provided with permanent magnet alignment rings. The effective alignment field intensities and directions can be adjusted, the minimum field strength position is indicated. The focus coil is situated inside the deflection coils, hence the focus power is reduced.

The housing consists of a mu-metal can for optimum screening from external magnetic fields and to form the required magnetic circuit for the deflection fields.

The camera tubes are secured in position by an aluminium nut-ring at the rear of the units and by means of a nylon glass tube.

The first stage of the video preamplifier is built in the yoke.

### Warning

No deformation of the calibrated mu-metal housing is allowed as this will strongly influence the performance and adjustments of the units.

### Catalogue number

The catalogue number of the triplet is 3122 137 18730.

The catalogue number of a single unit, AT1109/10S, 3122 137 18720.

MECHANICAL DATA

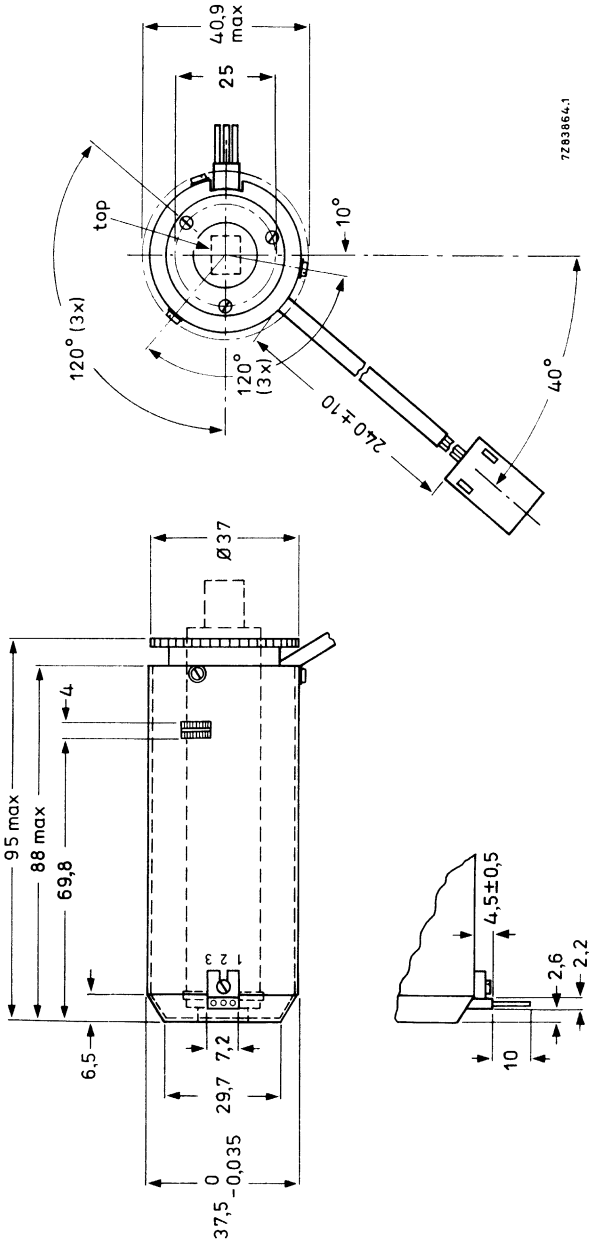

Mass per unit 230 g  
Operating body temperature range -15 to +65 °C

Fig. 1.

ELECTRICAL DATA (typical values)

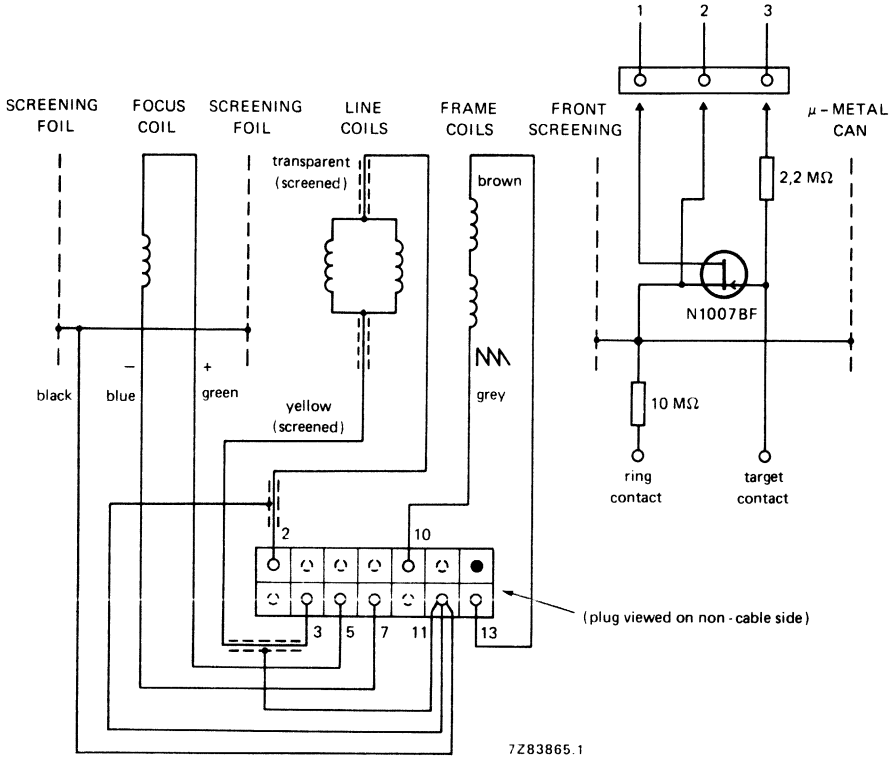

Fig. 2.

| coils                  | inductance<br>mH | resistance<br>Ω | current<br>mA  | connections         |
|------------------------|------------------|-----------------|----------------|---------------------|
| Line deflection coils  | 0,91 ± 5%        | 3,8 ± 10%       | 230 ± 5% (p-p) | transparent; yellow |
| Frame deflection coils | 2,8 ± 5%         | 12,7 ± 10%      | 104 ± 5% (p-p) | brown; grey         |
| Focus coil*            |                  | 60 ± 10%        | 115 ± 5%       | green; blue         |

\* Polarity: the north-seeking end of a compass should be attracted to the image end of the unit.

**Requirements for normal operation (XQ3427).**

|                                  |              |      |          |   |                                   |
|----------------------------------|--------------|------|----------|---|-----------------------------------|
| Tube setting                     | $V_{g2}$     | =    | 300 V    | } | with respect to cathode potential |
|                                  | $V_{g3}$     | =    | 430 V    |   |                                   |
|                                  | $V_{g4}^*$   | =    | 750 V    |   |                                   |
|                                  | $V_{target}$ | =    | 45 V     |   |                                   |
| signal current                   | $I_s$        | =    | 150 nA   |   |                                   |
| beam current                     | $I_b$        | =    | 300 nA   |   |                                   |
| Alignment magnet field intensity |              | max. | 0,24 mT  |   |                                   |
|                                  |              | min. | 0,015 mT |   |                                   |

**Geometric distortion**

Ambient temperature 21 °C.

Measured at operating temperature.

**Distortion**

|                |      |                        |
|----------------|------|------------------------|
| inside circle  | max. | 0,5% of picture height |
| outside circle | max. | 1% of picture height   |
| Skew error     | max. | 1% of picture height   |

**Registration**

The misregistration in any triplet (measured after skew correction) is not greater than:

- 20 ns in zone A,
- 40 ns in zone B,
- 80 ns in zone C.

The errors are measured both in horizontal and vertical direction and are expressed in units of 1/52000 of an active scan duration which is equivalent (horizontally) to 1 ns for CCIR corresponding to approximately 0,00256% ( $25 \times 10^{-6}$ ) related to picture height.

**Capacitance of tube target (XQ3427).**

The capacitance between the target and the electrodes increases less than 2 pF when the tube is inserted into the deflection unit.

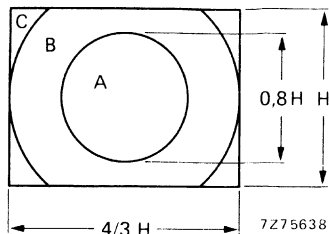

Fig. 3 Nominal scanning area: 6,6 mm x 8,8 mm ( $H = 6,6$  mm).

\*  $V_{g4}$  to be adjusted for minimum beam landing error to compensate for tube tolerances.

# DEVELOPMENT DATA

This data sheet contains advance information and specifications are subject to change without notice.

AT1109/16

## DEFLECTION UNITS FOR 2/3-INCH PLUMBICON TUBE with low output capacitance

### QUICK REFERENCE DATA

|                        | inductance | resistance    |
|------------------------|------------|---------------|
| Line deflection coils  | 0,91 mH    | 3,8 $\Omega$  |
| Frame deflection coils | 2,8 mH     | 12,7 $\Omega$ |
| Focus coil             | —          | 60 $\Omega$   |
| Alignment coils        | —          | 300 $\Omega$  |

### APPLICATION

The AT1109/16 is a rear-loaded deflection unit for use in colour television cameras using 2/3 inch pick-up tubes e.g. Plumbicon<sup>®</sup> tubes, type XQ3427, with low output capacitance (LOC).

The small dimensions and low weight make them specially suitable for use in portable ENG cameras.

### DESCRIPTION

The deflection units contain the deflection and focus coils and are provided with alignment coils. The effective alignment field intensities and directions can be adjusted. The focus coil is situated inside the deflection coils, hence the focus power is reduced.

The housing consists of a mu-metal can for optimum screening from external magnetic fields and to form the required magnetic circuit for the deflection fields.

The camera tubes are secured in position by an aluminium nut-ring at the rear of the units and by means of a nylon glass tube.

The first stage of the video preamplifier is built in the yoke.

### Warning

No deformation of the calibrated mu-metal housing is allowed as this will strongly influence the performance and adjustments of the units.

### Catalogue number

The catalogue number 8222 034 80190 for single unit AT1109/16S.

The catalogue number 8222 034 80160 for selected triplet AT1109/16T.

<sup>®</sup> Registered trade mark for television camera tube.

MECHANICAL DATA

Dimensions in mm

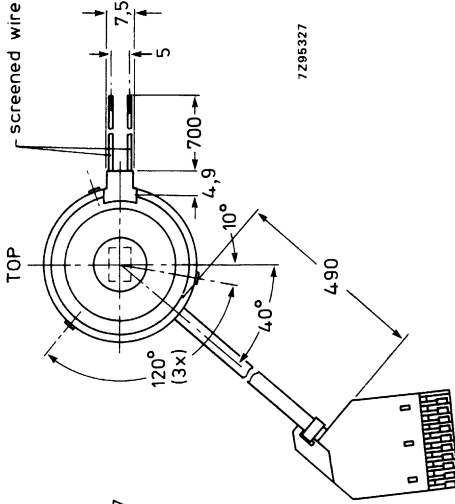
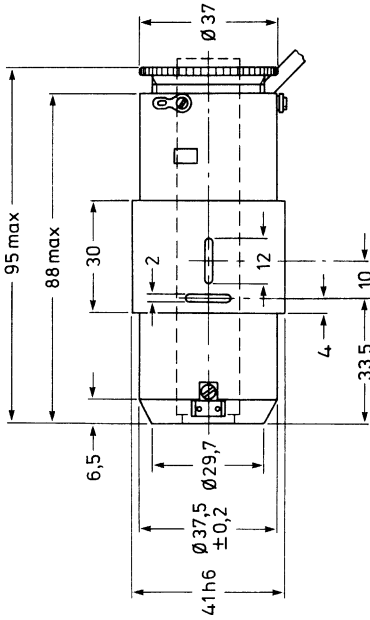

for detail of plug see Fig. 2.

Mass per unit 260 g  
 Operating body temperature range  $-15$  to  $+65$  °C

Fig. 1.



ELECTRICAL DATA (typical values)

DEVELOPMENT DATA

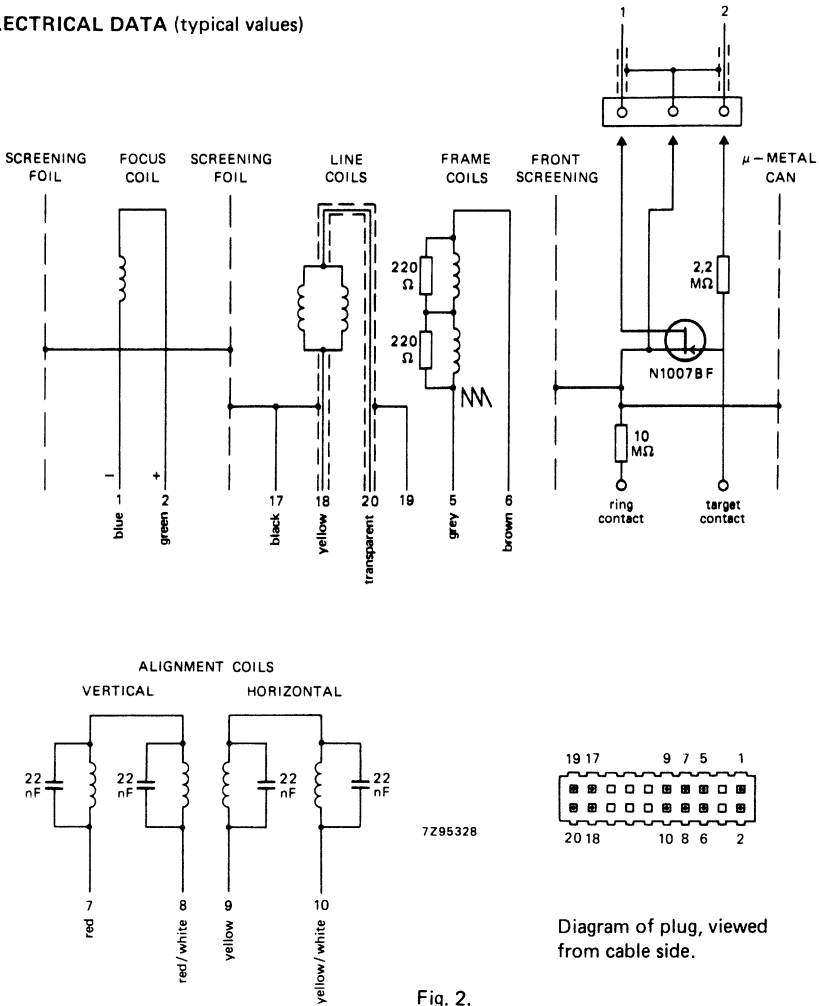

Fig. 2.

| coils                                     | inductance<br>mH | resistance<br>Ω | current<br>mA       | connections                            |
|---|------------------|-----------------|---------------------|--|
| Line deflection coils                     | $0,91 \pm 5\%$   | $3,8 \pm 10\%$  | $230 \pm 5\%$ (p-p) | transparent; yellow                    |
| Frame deflection coils                    | $2,8 \pm 5\%$    | $12,7 \pm 10\%$ | $104 \pm 5\%$ (p-p) | brown; grey                            |
| Focus coil*                               |                  | $60 \pm 10\%$   | $115 \pm 5\%$       | green; blue                            |
| Alignment coils<br>vertical<br>horizontal |                  | $300 \pm 10\%$  | 8,4 (for 0,2 mT)    | red; red/white<br>yellow; yellow/white |

\* Polarity: the north-seeking end of a compass should be attracted to the image end of the unit.

**Requirements for normal operation (XQ3427).**

|                |              |   |        |                                     |
|----------------|--------------|---|--------|-------------------------------------|
| Tube setting   | $V_{g2}$     | = | 300 V  | } with respect to cathode potential |
|                | $V_{g3}$     | = | 430 V  |                                     |
|                | $V_{g4}^*$   | = | 750 V  |                                     |
|                | $V_{target}$ | = | 45 V   |                                     |
| signal current | $I_s$        | = | 150 nA |                                     |
| beam current   | $I_b$        | = | 300 nA |                                     |

**Geometric distortion**

Ambient temperature 21 °C.

Measured at operating temperature.

**Distortion**

|             |      |                        |
|-------------|------|------------------------|
| zone A      | max. | 0,5% of picture height |
| zones B + C | max. | 1% of picture height   |
| Skew error  | max. | 1% of picture height   |

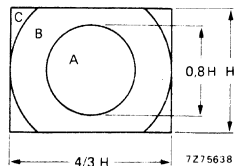

Fig. 3 Nominal scanning area: 6,6 mm x 8,8 mm (H = 6,6 mm).

**Registration**

The misregistration in any triplet (measured after skew correction) is not greater than:

- 30 ns in zone A,
- 60 ns in zone B,
- 120 ns in zone C.

The errors are measured both in horizontal and vertical direction and are expressed in units of  $1/52000$  of an active scan duration which is equivalent (horizontally) to 1 ns for CCIR corresponding to approximately  $0,00256\%$  ( $25 \times 10^{-6}$ ) related to picture height.

**Capacitance of tube target (XQ3427).**

The capacitance between the target and the electrodes increases less than 2 pF when the tube is inserted into the deflection unit.

\*  $V_{g4}$  to be adjusted for minimum beam landing error to compensate for tube tolerances.

## DEFLECTION UNITS FOR 1-INCH PLUMBICON TUBE

computer-selected triplet

### QUICK REFERENCE DATA

|                        | inductance | resistance    |
|------------------------|------------|---------------|
| Line deflection coils  | 0,78 mH    | 2,4 $\Omega$  |
| Frame deflection coils | 26 mH      | 64 $\Omega$   |
| Focus coil             |            | 1760 $\Omega$ |

### APPLICATION

The AT1115/01 is a triplet of rear loaded deflection units for use in broadcast colour television cameras using 1-inch tubes, e.g. Plumbicon® tubes XQ1080, XQ1500, XQ2070/02 series.

### DESCRIPTION

The deflection units contain the deflection, alignment and focus coils.

Each unit is provided with a locking device at the front, in which a holder for a field flattener lens can be fitted without the use of tools.

The camera tubes are secured in position by a plastic nut-ring at the rear of a unit. By turning the ring the tube will be pushed forward until it touches the stop. Space has been provided to build in a video pre-amplifier (connections A, C and D see dimensional drawing).

### Catalogue number

The catalogue number of the triplet is 3122 137 12710.

The catalogue number of a single unit, AT1119/01, is 3122 137 12700.

MECHANICAL DATA

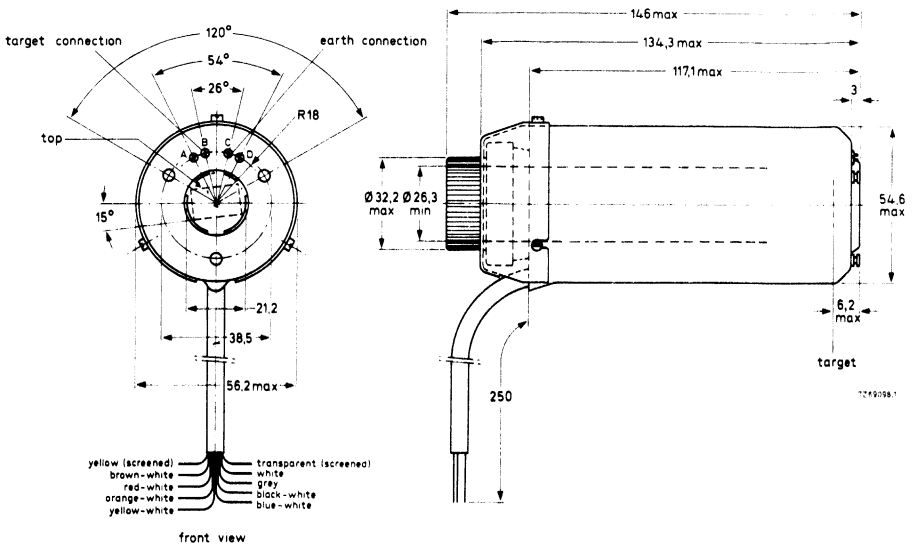

Mass per unit 560 g approx.

Body temperature

Temperature range  
 for continuous operation -15 to +75 °C  
 for non-operating -25 to +85 °C

ELECTRICAL DATA (typical values)

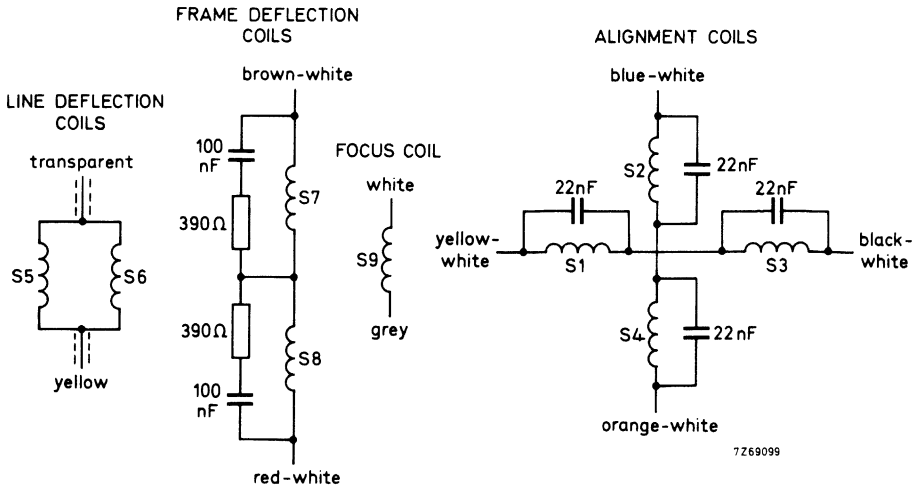

| coils                      | inductance<br>mH | resistance<br>$\Omega$ | connections                                  |
|----------------------------|------------------|------------------------|--|
| Line deflection coils      | $79 \pm 3\%$     | $2,1 \pm 5\%$          | transparent (screened);<br>yellow (screened) |
| Frame deflection coils     | 26               | $62 \pm 8\%$           | red-white; brown-white                       |
| Horizontal alignment coils |                  | $550 \pm 10\%$         | yellow-white; black-white                    |
| Vertical alignment coils   |                  | $550 \pm 10\%$         | orange-white; blue-white                     |
| Focus coil*                |                  | $1718 \pm 10\%$        | grey (+); white (-)                          |

**Required currents for normal operation (XQ1080)**

Tube setting:

$$\left. \begin{array}{l} V_{g5} = +470 \text{ V} \\ V_{g6} = +750 \text{ V} \end{array} \right\} \text{ with respect to cathode potential}$$

Nominal scanning area: 9,6 mm x 12,8 mm

Dynamic focus on  $V_{g5}$

|                               |   |
|-------------------------------|---|
| Line deflection current, p-p  | 260 mA  |
| Frame deflection current, p-p | 36 mA   |
| Focus current                 | 32 mA   |
| Alignment current             | 1 mA will cause a shift of $\leq 0,6\%$ of picture height |

**Geometric distortion**

|   |                             |
|---|-----------------------------|
| Distortion, measured with dynamic focus |                             |
| inside the circle                       | max. 0,5% of picture height |
| outside the circle                      | max. 1% of picture height   |
| Skew error                              | max. 0,4% of picture height |

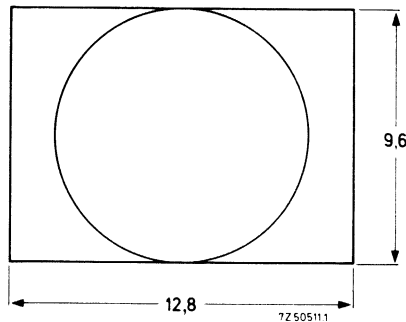

\* Polarity: the north-seeking pole of a compass should be attracted to the image end of the unit.

**Registration**

The deflection units are supplied in matched sets of three units wherein the misregistration in any set is not greater than:

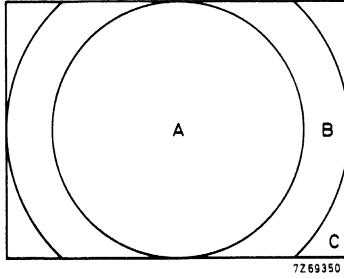

- in zone A 25 ns
- in zone B 40 ns
- in zone C 80 ns

The errors are measured horizontally and vertically.

The difference between the focus currents of the deflection units of a selected triplet shall not exceed  $\pm 1\%$ , measured at one tube as a reference.

**Capacitance of the tube target**

The capacitance between the target and the tube electrodes increases less than 6 pF, when the tube is inserted in the deflection unit.

## DEFLECTION UNITS FOR 1-INCH PLUMBICON TUBE

computer-selected triplet

### QUICK REFERENCE DATA

|                        | inductance | resistance   |
|------------------------|------------|--------------|
| Line deflection coils  | 0,79 mH    | 2,2 $\Omega$ |
| Frame deflection coils | 28 mH      | 62 $\Omega$  |
| Focus coil             |            | 140 $\Omega$ |

### APPLICATION

The AT1116/06 is a triplet of front loaded deflection units for use in broadcast colour television cameras using 1-inch camera tubes, e.g. Plumbicon® tubes of the XQ1070/03 and XQ2070/03 series.

### DESCRIPTION

The deflection units contain the deflection, alignment and focus coils.

The camera tubes are secured in position by a plastic nut-ring at the rear of a unit. By turning the ring the tube will be pushed backward until it touches the stop.

### Catalogue number

The catalogue number of the triplet is 3122 137 15040.

The catalogue number of a single unit, AT1116S, is 3122 137 15050.

**MECHANICAL DATA**

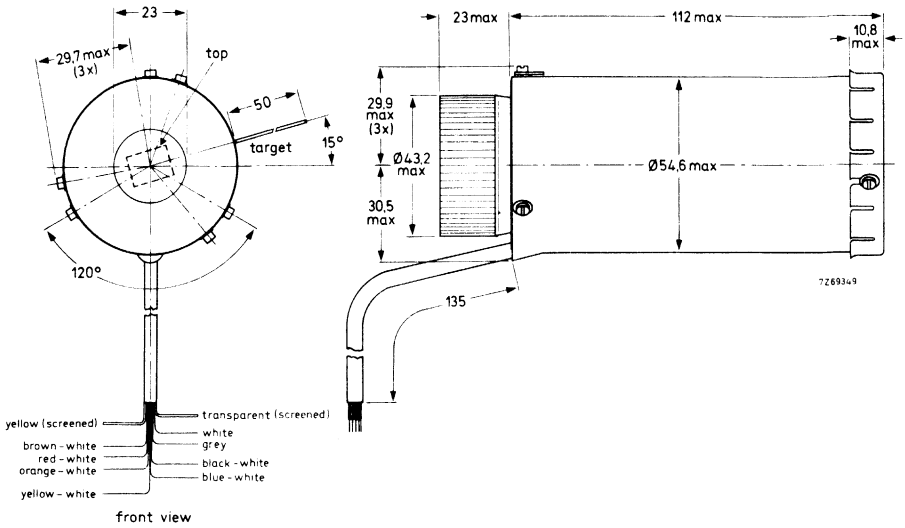

Mass per unit 615 g approx.

**Body temperature**

**Temperature range**

- for continuous operation -15 to + 75 °C
- for non-operating -25 to + 85 °C

**ELECTRICAL DATA (typical values)**

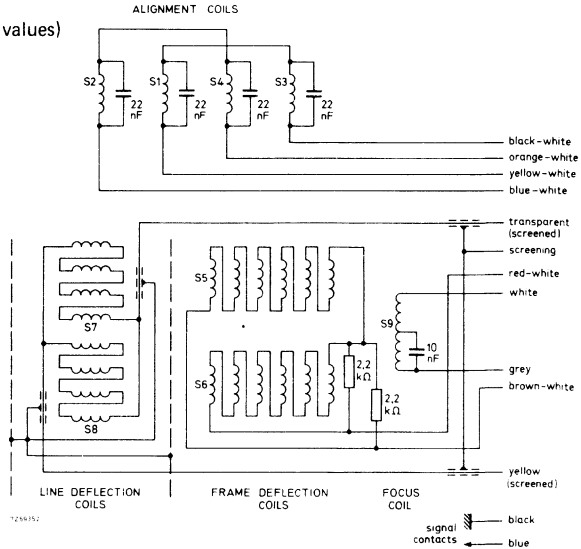



| coils                      | inductance<br>mH | resistance<br>$\Omega$ | connections                                  |
|----------------------------|------------------|------------------------|--|
| Line deflection coils      | $0,79 \pm 5\%$   | $2,2 \pm 10\%$         | transparent (screened);<br>yellow (screened) |
| Frame deflection coils     | $28 \pm 5\%$     | $62 \pm 10\%$          | red-white; brown-white                       |
| Horizontal alignment coils |                  | $550 \pm 10\%$         | yellow-white; black-white                    |
| Vertical alignment coils   |                  | $550 \pm 10\%$         | orange-white; blue-white                     |
| Focus coil*                |                  | $140 \pm 10\%$         | grey (+); white (-)                          |

**Required currents for normal operation (XQ1070)**

Tube setting:

$$\left. \begin{array}{l} V_{g3} = +600 \text{ V} \\ V_{g4} = +960 \text{ V} \end{array} \right\} \text{ with respect to cathode potential}$$

Nominal scanning area: 9,6 mm x 12,8 mm

|                               |   |
|-------------------------------|---|
| Line deflection current, p-p  | 280 mA  |
| Frame deflection current, p-p | 34 mA   |
| Focus current                 | 108 mA  |
| Alignment current             | 1 mA will cause a shift of 0,6% of picture height |

\* Polarity: the north-seeking pole of a compass should be attracted to the image end of the unit.

**Geometric distortion**

**Distortion**

|                    |                             |
|--------------------|-----------------------------|
| inside the circle  | max. 0,5% of picture height |
| outside the circle | max. 1% of picture height   |

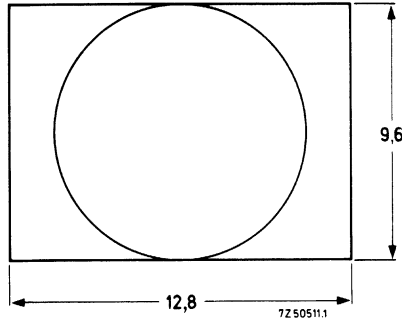

**Registration**

The deflection units are supplied in matched sets of three units wherein the misregistration in any set is not greater than:

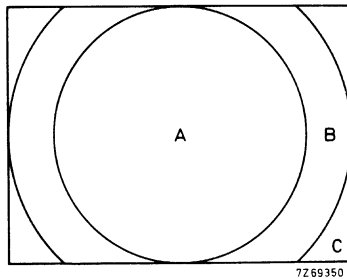

|           |       |
|-----------|-------|
| in zone A | 25 ns |
| in zone B | 40 ns |
| in zone C | 80 ns |

The errors are measured horizontally and vertically.

**DEFLECTION UNITS**  
**FOR ½-INCH H.S. 'DIODE-GUN' PLUMBICON TUBE**  
 computer selected triplet

**QUICK REFERENCE DATA**

|                        | inductance  | resistance    |
|------------------------|-------------|---------------|
| Line deflection coils  | 325 $\mu$ H | 6,2 $\Omega$  |
| Frame deflection coils | 1,1 mH      | 14,1 $\Omega$ |

**APPLICATION**

The AT1120T is a computer selected triplet of deflection units for use in colour television cameras using front-loading ½-inch H.S. diode electron gun Plumbicon<sup>®</sup> tubes with magnetic deflection and electrostatic focus, type XQ4087.

Their small size and low weight make these units specially suitable for use in portable ENG cameras.

**DESCRIPTION**

The deflection unit contains the horizontal and vertical deflection coils. With the H.S. diode gun Plumbicon tubes no alignment correction is required. The tube socket is integrated in the unit, all tube connections form part of the deflection unit assembly. The housing is a mu-metal can for optimum screening from external magnetic fields and forms the required magnetic circuit for the deflection fields.

**WARNING**

No deformation of the mu-metal housing is allowed as this would strongly affect the performance and adjustment of the unit.

**CATALOGUE NUMBER**

|             |          |                |
|-------------|----------|----------------|
| Triplet     | AT1120T: | 3122 137 18860 |
| Single unit | AT1120S: | 3122 137 18870 |

**ELECTRICAL DATA** (Deflection coil + tube connections)

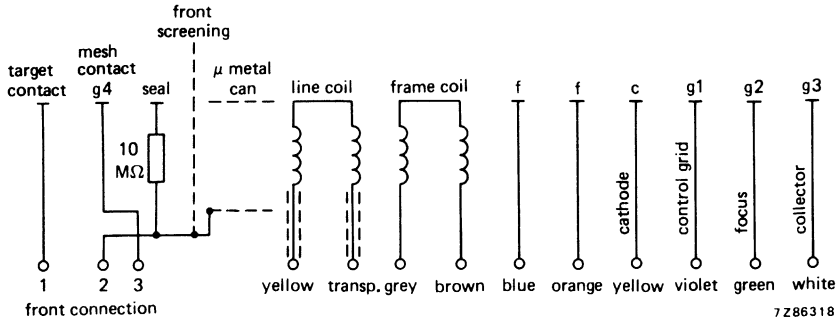

Fig. 1.

|                            |   |
|----------------------------|---|
| Horizontal deflection coil | inductance $325 \mu\text{H} \pm 5\%$ , resistance $6,2 \Omega \pm 10\%$ . |
| Vertical deflection coil   | inductance $1,1 \text{ mH} \pm 5\%$ , resistance $14,1 \Omega \pm 10\%$ . |

Measured with bridge  $f = 1000 \text{ Hz}$ ,  $T_{\text{amb}} = 25 \text{ }^\circ\text{C}$ :

**Deflection current:**

|                            |                  |
|----------------------------|------------------|
| Horizontal deflection coil | $190 \pm 5\%$ mA |
| Vertical deflection coil   | $92 \pm 5\%$ mA  |

**Distortion:**

|           |                              |
|-----------|------------------------------|
| geometric | $\leq 1\%$ of picture height |
| skew      | $\leq 1\%$ of picture height |

**Registration**

The deflection units are supplied in matched sets of three units. The misregistration in any set is not greater than:

- 40 ns in zone A
- 80 ns in zone B
- 120 ns in zone C

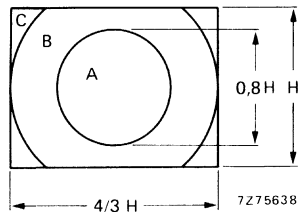

Fig. 2

Nominal scanning area:  $4,8 \text{ mm} \times 6,4 \text{ mm}$  ( $H = 4,8 \text{ mm}$ ).

The errors are measured both in horizontal and vertical direction after skew correction, with one tube as a reference. Tube settings according to the XQ4087 data sheet.

**Capacitance**

Target contact of the tube/coil assembly to any other contact  $C_{\text{as}} \approx 3,5 \text{ pF}$ .

MECHANICAL DATA

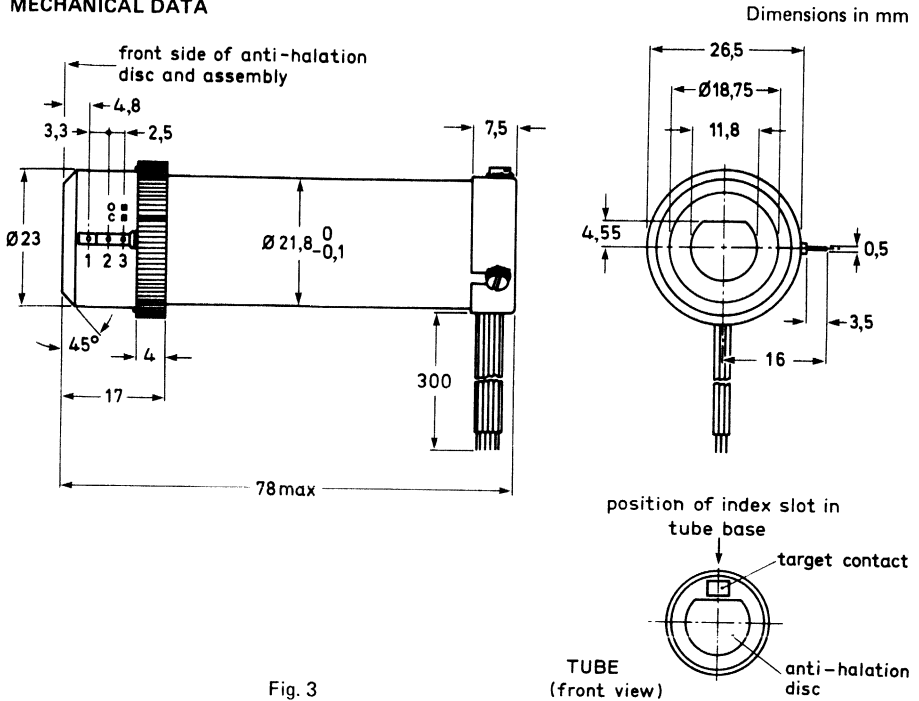

Fig. 3

7285400.2

Mass per unit : 53 g

Operating body temperature range : -15 to + 70 °C

To replace a tube unscrew the ring at the front end of the deflection unit by turning the marker on the ring to position "0".

Remove the metal front part and push gently on the base of the tube through the hole in the rear end of the unit.

For proper insertion of a tube the index slot in the tube base should be in the position indicated by the arrow on the front end of the deflection unit. The deflection units should be mounted in the camera with the tube target contact positioned upwards.



## DEFLECTION UNITS FOR 1-INCH PLUMBICON® TUBES

with low output capacitance

### QUICK REFERENCE DATA

|                        | inductance | resistance    |
|------------------------|------------|---------------|
| Line deflection coils  | 0,800 mH   | 2,2 $\Omega$  |
| Field deflection coils | 4,4 mH     | 10 $\Omega$   |
| Focus coil             |            | 1300 $\Omega$ |

### APPLICATION

The AT1126 is a triplet of rear-loaded deflection units for use in colour television cameras using 1 inch pick-up tubes e.g. Plumbicon® tubes, types XQ1500 and XQ3070, with low output capacitance (LOC).

### DESCRIPTION

The deflection units contain the deflection, focus and alignment coils.

The housing is a mu-metal can for optimum screening from external magnetic fields and to form the required magnetic circuit for the deflection fields.

The camera tubes are secured in position by a threaded ring at the rear of the units.

The first stage of the video preamplifier is built into the yoke.

### Warning

The mu-metal housing must not be deformed as this will strongly influence the performance and adjustments of the units.

### Catalogue number

Triplet AT1126: 3122 137 19060;

Single unit AT1126S: 3122 137 19050.





ELECTRICAL DATA (typical values)

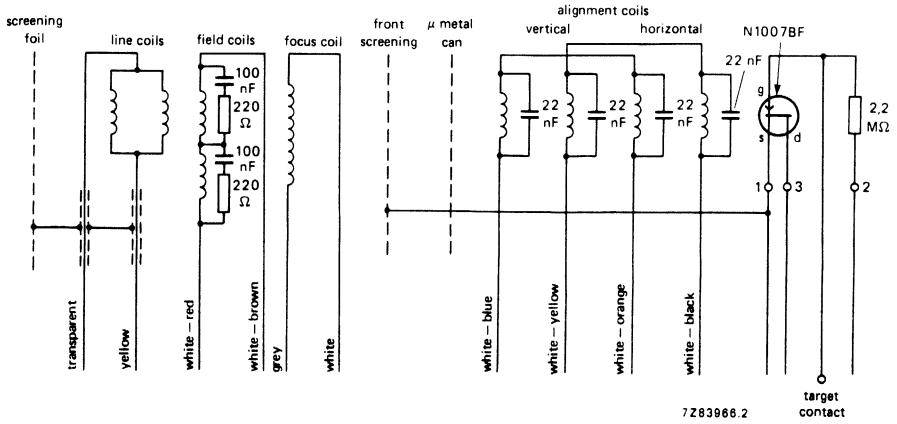

Fig. 2.

| coils (see Fig. 2)     | inductance<br>mH | resistance<br>Ω | current<br>mA  |
|------------------------|------------------|-----------------|----------------|
| Line deflection coils  | 0,800 ± 5%       | 2,2 ± 10%       | 230 ± 5% (p-p) |
| Field deflection coils | 4,4 ± 5%         | 10 ± 10%        | 80 ± 5% (p-p)  |
| Focus coil*            |                  | 1300 ± 10%      | 30 ± 5%        |
| Alignment coils        |                  | 530 ± 10%       |                |

\* Polarity: the image end of the unit should attract the north pole of a compass.

**Requirements for normal operation (XQ1500)**

|                |              |   |        |                                     |
|----------------|--------------|---|--------|-------------------------------------|
| Tube setting   | $V_{g2,g4}$  | = | 300 V  | } with respect to cathode potential |
|                | $V_{g5}$     | = | 475 V  |                                     |
|                | $V_{g6^*}$   | = | 750 V  |                                     |
|                | $V_{target}$ | = | 45 V   |                                     |
| signal current | $I_s$        | = | 200 nA |                                     |
| beam current   | $I_b$        | = | 400 nA |                                     |

Alignment current of 1 mA will cause a shift of  $\leq 0,7\%$  of picture height.

**Geometric distortion**

Ambient temperature 21 °C.

Measured at operating temperature.

**Distortion**

|                |      |                        |
|----------------|------|------------------------|
| inside zone A  | max. | 0,5% of picture height |
| outside zone A | max. | 1% of picture height   |
| Skew error     | max. | 0,5% of picture height |

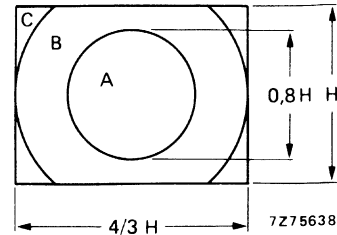

Fig. 3.

Nominal scanning area: 9,6 mm x 12,8 mm  
(H = 9,6 mm)

**Registration**

The misregistration in any triplet (measured after skew correction) is not greater than:

- 40 ns in zone A
- 50 ns in zone B
- 80 ns in zone C

The errors are measured both in horizontal and vertical direction and are expressed in units of  $1/52000$  of an active scan duration which is equivalent (horizontally) to 1 ns for CCIR corresponding to approximately  $0,00256\%$  ( $25 \times 10^{-6}$ ) related to picture height.

**Capacitance of tube target**

The capacitance between the target and the electrodes increases less than 3,5 pF, when the tube is inserted into the deflection unit, and measured without FET-preamplifier.

\*  $V_{g6}$  to be adjusted for minimum beam landing error to compensate for tube tolerances.

## DEFLECTION UNITS FOR 30 mm PLUMBICON® TUBE

### QUICK REFERENCE DATA

|                        | inductance | resistance    |
|------------------------|------------|---------------|
| Line deflection coils  | 0,835 mH   | 2,1 $\Omega$  |
| Field deflection coils | 5,5 mH     | 14,5 $\Omega$ |
| Focus coil             |            | 1125 $\Omega$ |

### APPLICATION

The AT1130 is a triplet of rear-loaded deflection units for use in colour television cameras using 30 mm pick-up tubes e.g. Plumbicon® tubes, types XQ1410, XQ1520.

### DESCRIPTION

The deflection units contain the deflection, focus and alignment coils.

The housing is a mu-metal can for optimum screening from external magnetic fields and to form the required magnetic circuit for the deflection fields.

The camera tubes are secured in position by a threaded ring at the rear of the units.

The first stage of the video preamplifier is built into the yoke.

### Warning

The mu-metal housing must not be deformed as this will strongly influence the performance and adjustments of the units.

### Catalogue number

Triplet AT1130: 3122 137 18880;

Single unit AT1130S: 3122 137 18890.

MECHANICAL DATA

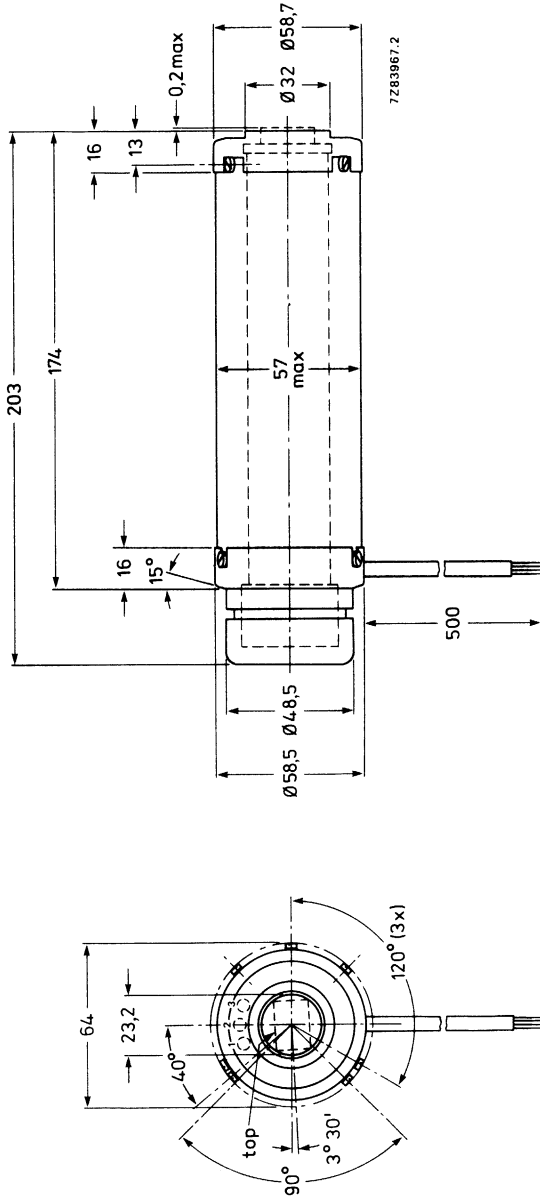
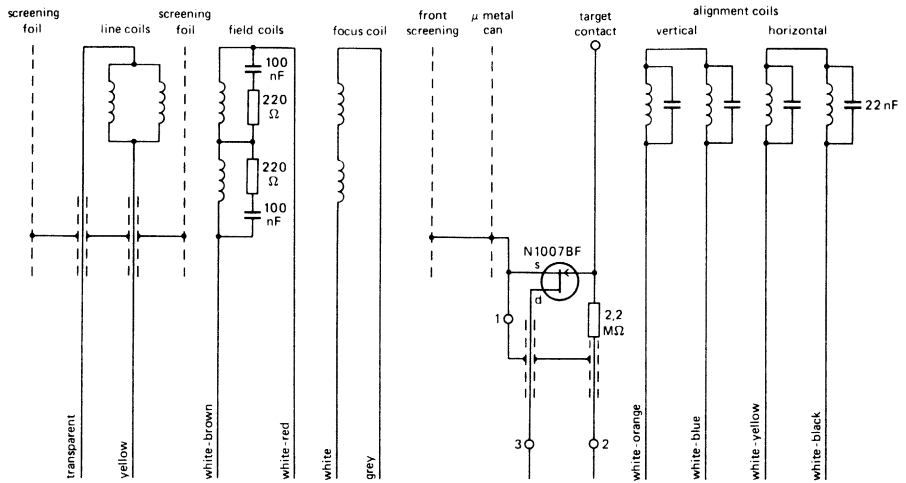

Fig. 1.

Mass per unit approx. 865 g  
Operating body temperature range  $-15$  to  $+65$  °C

ELECTRICAL DATA (typical values)



7283965.1

Fig. 2.

| coils (see Fig. 2)     | inductance<br>mH | resistance<br>Ω | current<br>mA  |
|------------------------|------------------|-----------------|----------------|
| Line deflection coils  | 0,835 ± 5%       | 2,1 ± 10%       | 180 ± 5% (p-p) |
| Field deflection coils | 5,5 ± 5%         | 14,5 ± 10%      | 55 ± 5% (p-p)  |
| Focus coil*            |                  | 1125 ± 10%      | 35 ± 5%        |
| Alignment coils        |                  | 530 ± 10%       |                |

\* Polarity: the image end of the unit should repel the north pole of a compass.

**Requirements for normal operation (XQ1410)**

|                |              |   |        |                                     |
|----------------|--------------|---|--------|-------------------------------------|
| Tube setting   | $V_{g2}$     | = | 300 V  | } with respect to cathode potential |
|                | $V_{g3}$     | = | 600 V  |                                     |
|                | $V_{g4}^*$   | = | 675 V  |                                     |
|                | $V_{target}$ | = | 45 V   |                                     |
| signal current | $I_s$        | = | 300 nA |                                     |
| beam current   | $I_b$        | = | 600 nA |                                     |

Alignment current of 8,8 mA will cause a flux of 0,2 mT.

**Geometric distortion**

Ambient temperature 21 °C.

Measured at operating temperature.

**Distortion**

|                |      |                        |
|----------------|------|------------------------|
| inside zone A  | max. | 0,5% of picture height |
| outside zone A | max. | 1% of picture height   |
| Skew error     | max. | 0,5% of picture height |

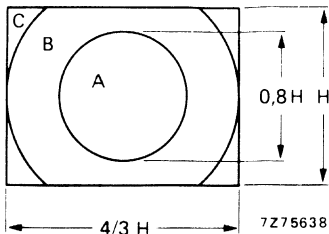

Fig. 3.

Nominal scanning area: 12,8 mm x 17,1 mm  
(H = 12,8 mm)

**Registration**

The misregistration in any triplet (measured after skew correction) is not greater than:

- 40 ns in zone A
- 50 ns in zone B
- 80 ns in zone C

The errors are measured both in horizontal and vertical direction and are expressed in units of 1/52000 of an active scan duration which is equivalent (horizontally) to 1 ns for CCIR corresponding to approximately 0,00256% ( $25 \times 10^{-6}$ ) related to picture height.

**Capacitance of tube target (XQ1410, XQ1520)**

The capacitance between the target and the electrodes increases less than 5,5 pF when the tube is inserted into the deflection unit.

\*  $V_{g4}$  to be adjusted for minimum beam landing error to compensate for tube tolerances.

# DEVELOPMENT DATA

This data sheet contains advance information and specifications are subject to change without notice.

KV4722

## FOCUSING UNIT FOR 2/3 INCH PLUMBICON TUBES with M.S. Diode gun

### QUICK REFERENCE DATA

---

|                            |               |
|----------------------------|---------------|
| Focus coil resistance      | 25,2 $\Omega$ |
| Alignment coils resistance | 567 $\Omega$  |

---

### APPLICATION

The KV4722 is a focusing and alignment unit for 2/3 inch "diode" electron gun Plumbicon<sup>®</sup> tubes with magnetic focus and electrostatic deflection (M.S.), type XQ3457.

### DESCRIPTION

The unit contains the focus coil and the horizontal and vertical alignment coils. The housing is a mu-metal can for optimum screening from external magnetic fields.

### Warning

No deformation of the mu-metal housing is allowed as this would strongly affect the performance of the unit.

### Catalogue number

Single unit KV4722: 9390 304 60000;  
For a 3-tube colour camera 3 single units must be ordered.

<sup>®</sup> Registered trade mark for television camera tubes.

MECHANICAL DATA

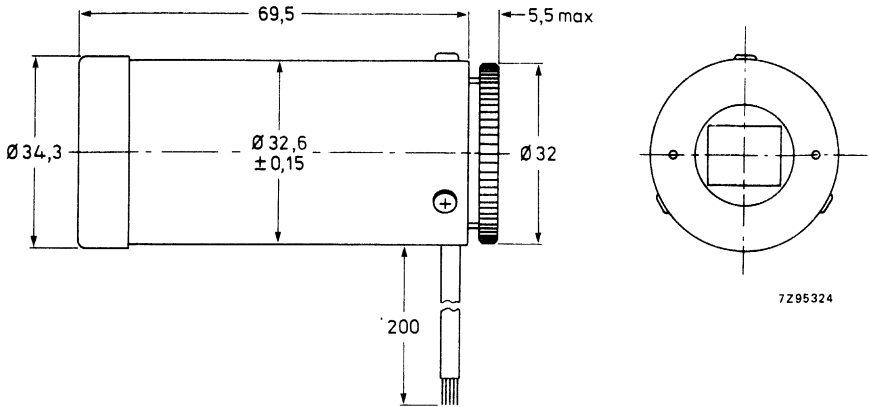

ELECTRICAL DATA

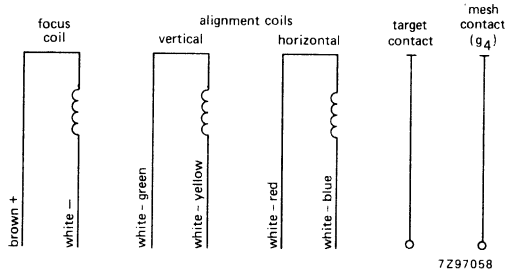

| coils (see Fig. 2) | resistance<br>$\Omega$ | current<br>mA   | field<br>mT    |
|--------------------|------------------------|-----------------|----------------|
| focus coil         | $25,2 \pm 10\%$        | $198 \pm 10\%$  | $7 \pm 10\%$   |
| alignment coils    | $567 \pm 10\%$         | $17,5 \pm 10\%$ | $0,4 \pm 10\%$ |

Tube settings according to XQ3457 tube data.



# DEVELOPMENT DATA

This data sheet contains advance information and specifications are subject to change without notice.

KV4736-3

## DEFLECTION UNIT FOR 2/3 INCH PLUMBICON TUBES with H.S. "Diode" gun, computer selected triplet

### QUICK REFERENCE DATA

|                        | inductance | resistance    |
|------------------------|------------|---------------|
| Line deflection coils  | 1,14 mH    | 4,6 $\Omega$  |
| Frame deflection coils | 2,37 mH    | 25,4 $\Omega$ |

### APPLICATION

The KV4736-3 is a computer selected triplet of deflection units for use in colour television cameras using front-loading 2/3 inch H.S. "diode" electron Plumbicon<sup>®</sup> tubes with magnetic deflection and electrostatic focus, type XQ4187. Their small size and low weight make these units specially suitable for use in portable ENG cameras.

### DESCRIPTION

The deflection unit contains the horizontal and vertical deflection coils. With the H.S. "diode" electron gun Plumbicon tubes no alignment correction is required. The tube socket is integrated in the unit, all tube connections form part of the deflection unit assembly. The housing is a mu-metal can for optimum screening from external magnetic fields and forms the required magnetic circuit for the deflection fields.

### Warning

No deformation of the mu-metal housing is allowed as this would strongly affect the performance and adjustment of the unit.

### Catalogue number

Triplet KV4736-3AT : 9390 304 90000

Single unit KV4736-3AS : 9390 304 80000

MECHANICAL DATA

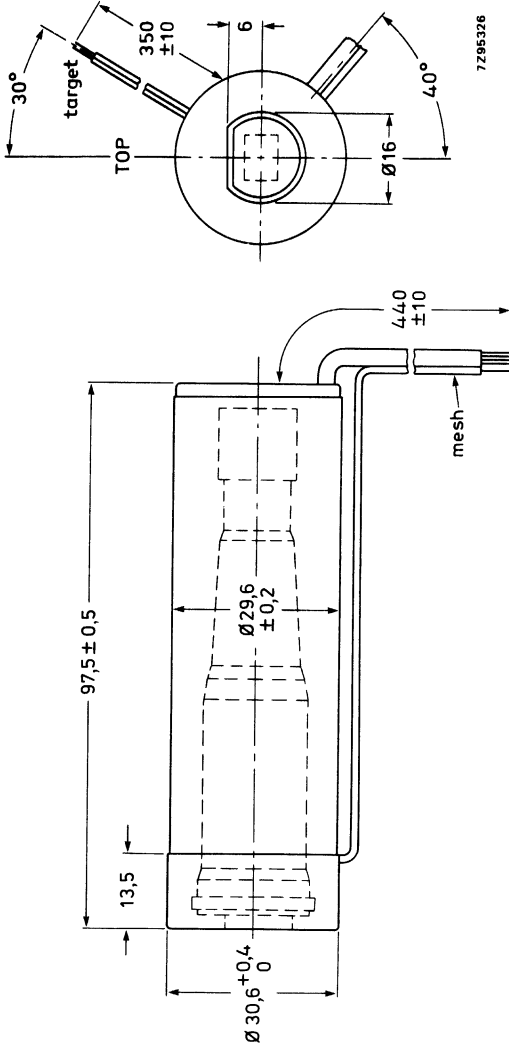

Mass per unit: 115 g

Operating body temperature range:  $-15$  to  $70$  °C

To replace a tube unscrew the front cap of the deflection unit. Remove the metal front part and push gently on the base of the tube through the hole in the rear end of the unit.

The deflection units should be mounted in the camera with the tube target contact positioned upward.

**ELECTRICAL DATA**

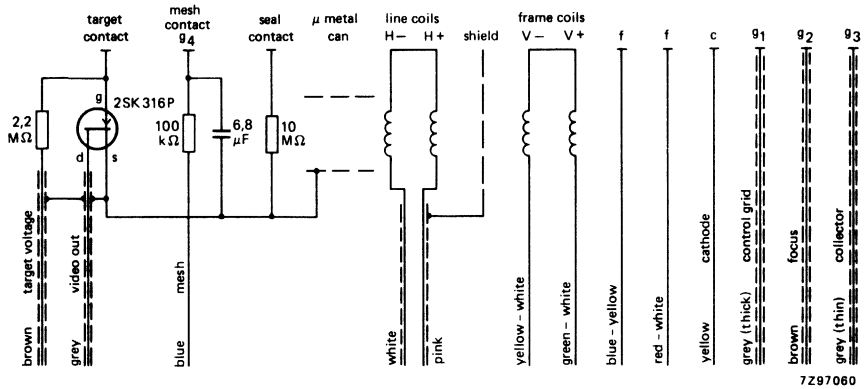

Fig. 1.

DEVELOPMENT DATA

| coils                 | inductance<br>mH | resistance<br>Ω | current<br>mA |
|-----------------------|------------------|-----------------|---------------|
| horizontal deflection | 1,14 ± 5%        | 4,6 ± 5%        | 170 ± 5%      |
| vertical deflection   | 2,37 ± 5%        | 25,4 ± 5%       | 85 ± 5%       |

Measured with bridge f = 1000 Hz, T<sub>amb</sub> = 25 °C

**Distortion**

- geometric ≤ 1% of picture height
- skew ≤ 1% of picture height

**Registration**

The deflection units are supplied in matched sets of three units. The misregistration in any set is not greater than:

- 40 ns in zone A
- 80 ns in zone B
- 120 ns in zone C

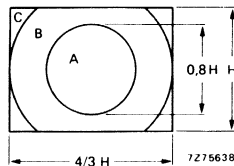

Fig. 2.

Nominal scanning area: 6,6 mm x 8,8 mm (H = 6,6 mm).

The errors are measured both in horizontal and vertical direction after skew correction, with one tube as a reference. Tube settings according to the XQ4187 data.

**Capacitance**

Target contact of the tube/coil assembly to any other contact

C<sub>as</sub> ≈ 3,5 pF

## DEFLECTION UNIT FOR 2/3 INCH PLUMBICON TUBES with electrostatic focus

### QUICK REFERENCE DATA

|                        | inductance | resistance    |
|------------------------|------------|---------------|
| Line deflection coils  | 1,17 mH    | 5,03 $\Omega$ |
| Frame deflection coils | 5,3 mH     | 33 $\Omega$   |
| Alignment coils        |            | 146 $\Omega$  |

### APPLICATION

The KV4780 is a deflection unit for 2/3 inch Plumbicon<sup>®</sup> tubes with magnetic deflection and electrostatic focus, type XQ3467.

### DESCRIPTION

The deflection unit contains the horizontal and vertical deflection coils and the alignment coils. The housing is a mu-metal can for optimum screening from external magnetic fields.

### Warning

No deformation of the mu-metal housing is allowed as this would strongly affect the performance and adjustment of the unit.

### Catalogue number

Single unit KV4780: 9390 304 70000

For a 3-tube colour camera 3 single units must be ordered.

<sup>®</sup> Registered trade mark for television camera tubes.

DEVELOPMENT DATA

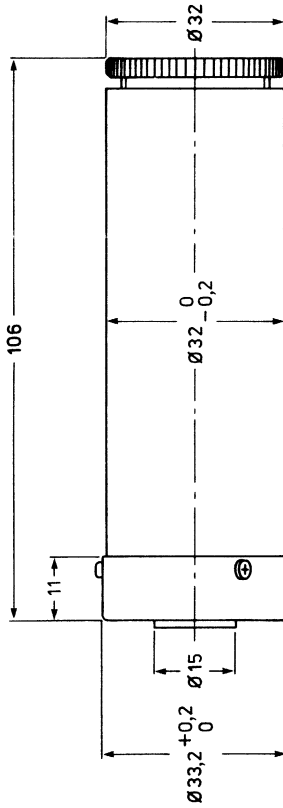
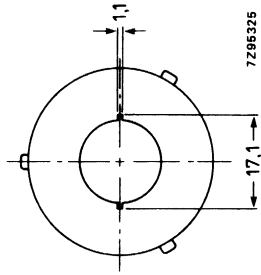

MECHANICAL DATA

Mass per unit: 110 g  
Operating body temperature range: -10 to 60 °C

ELECTRICAL DATA

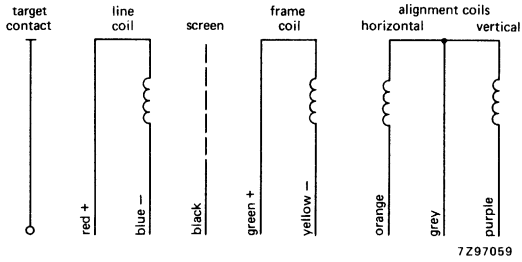

Fig. 2.

| coils, see Fig. 2     | inductance<br>mH | resistance<br>$\Omega$ | current<br>mA  | field<br>mT    |
|-----------------------|------------------|------------------------|----------------|----------------|
| Horizontal deflection | $1,17 \pm 10\%$  | $5,03 \pm 10\%$        | $175 \pm 10\%$ | $0,4 \pm 10\%$ |
| Vertical deflection   | $5,3 \pm 10\%$   | $33 \pm 10\%$          | $30 \pm 10\%$  |                |
| Alignment             |                  | $146 \pm 10\%$         | $22 \pm 10\%$  |                |

**Distortion**

- geometric  $\leq 1\%$  of picture height
- skew  $\leq 1,5\%$  of picture height

**Registration**

The misregistration in any set of 3 units is not greater than:

- 40 ns in zone A
- 80 ns in zone B
- 120 ns in zone C

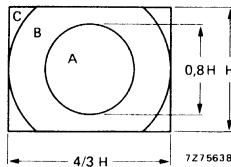

Fig. 2.

Nominal scanning area: 6,6 mm x 8,8 mm (H = 6,6 mm).

The errors are measured both in horizontal and vertical direction after skew correction, with one tube as a reference. Tube settings according to the XQ3467 data.

## INDEX OF TYPE NUMBERS





## INDEX OF TYPE NUMBERS

| type number | page | type number | page | type number | page |
|-------------|------|-------------|------|-------------|------|
| AT1109/01   | 253  | XQ1075      | 99   | XQ2074      | 157  |
| AT1109/10   | 257  | XQ1076      | 99   | XQ2075      | 157  |
| AT1109/16   | 261  | XQ1080      | 121  | XQ2076      | 157  |
| AT1115/01   | 265  | XQ1083      | 121  | XQ2172      | 167  |
| AT1116/06   | 269  | XQ1085      | 121  | XQ2427      | 197  |
| AT1119      | 265  | XQ1090      | 137  | XQ2428      | 197  |
| AT1120      | 273  | XQ1093      | 137  | XQ3070      | 177  |
| AT1126      | 277  | XQ1095      | 137  | XQ3071      | 177  |
| AT1130      | 281  | XQ1410      | 53   | XQ3073      | 177  |
| KV4722      | 285  | XQ1413      | 53   | XQ3074      | 177  |
| KV4736      | 287  | XQ1415      | 53   | XQ3075      | 177  |
| KV4780      | 290  | XQ1427      | 189  | XQ3076      | 177  |
| XQ1020      | 39   | XQ1428      | 189  | XQ3427      | 205  |
| XQ1021      | 39   | XQ1500      | 139  | XQ3440      | 81   |
| XQ1022      | 47   | XQ1503      | 139  | XQ3443      | 81   |
| XQ1023      | 39   | XQ1505      | 139  | XQ3445      | 81   |
| XQ1024      | 39   | XQ1510      | 155  | XQ3457      | 213  |
| XQ1025      | 39   | XQ1513      | 155  | XQ3467      | 221  |
| XQ1026      | 39   | XQ1515      | 155  | XQ4087      | 241  |
| XQ1070      | 99   | XQ1520      | 65   | XQ4187      | 229  |
| XQ1071      | 99   | XQ1523      | 65   | XQ4502      | 89   |
| XQ1072      | 109  | XQ1525      | 65   |             |      |
| XQ1073      | 99   | XQ2070      | 157  |             |      |
| XQ1073X     | 115  | XQ2071      | 157  |             |      |
| XQ1074      | 99   | XQ2073      | 157  |             |      |

For type numbers of Newvicon and Vidicon camera tubes see relevant Data Handbook.

**Argentina:** PHILIPS ARGENTINA S.A., Div. Elcoma, Vedia 3892, 1430 BUENOS AIRES, Tel. 541-7141/7242/7343/7444/7545.

**Australia:** PHILIPS INDUSTRIES HOLDINGS LTD., Elcoma Division, 11 Waltham Street, ARTARMON, N.S.W. 2064, Tel. (02)439 3322.

**Austria:** ÖSTERREICHISCHE PHILIPS BAUELEMENTE INDUSTRIE G.m.b.H., Triester Str. 64, A-1101 WIEN, Tel. 62 91 11.

**Belgium:** N.V. PHILIPS & MBLÉ ASSOCIATED, 9 rue du Pavillon, B-1030 BRUXELLES, Tel. (02) 242 74 00.

**Brazil:** IBRAPE, Caixa Postal 7383, Av. Brigadeiro Faria Lima, 1735 SAO PAULO, SP, Tel. (011) 211-2600.

**Canada:** PHILIPS ELECTRONICS LTD., Electron Devices Div., 601 Milner Ave., SCARBOROUGH, Ontario, M1B 1M8, Tel. 292-5161.

**Chile:** PHILIPS CHILENA S.A., Av. Santa Maria 0760, SANTIAGO, Tel. 39-4001.

**Colombia:** IND. PHILIPS DE COLOMBIA S.A., c/o IPRELENSO LTD., Calle 17, No. 9-21, Of. 202, BOGOTA, D.E., Tel. 57-2347493.

**Denmark:** MINIWATT A/S, Strandlodsvej 2, P.O. Box 1919, DK 2300 COPENHAGEN S, Tel. (01) 54 11 33.

**Finland:** OY PHILIPS AB, Elcoma Division, Kaivokatu 8, SF-00100 HELSINKI 10, Tel. 1 72 71.

**France:** R.T.C. LA RADIOTECHNIQUE-COMPELEC, 130 Avenue Ledru Rollin, F-75540 PARIS 11, Tel. 338 80-00.

**Germany (Fed. Republic):** VALVO, UB Bauelemente der Philips G.m.b.H., Valvo Haus, Burchardstrasse 19, D-2 HAMBURG 1, Tel. (040) 3296-0.

**Greece:** PHILIPS S.A. HELLENIQUE, Elcoma Division, 52, Av. Syngrou, ATHENS, Tel. 9215111.

**Hong Kong:** PHILIPS HONG KONG LTD., Elcoma Div., 15/F Philips Ind. Bldg., 24-28 Kung Yip St., KWAI CHUNG, Tel. (0)-2451 21.

**India:** PEICO ELECTRONICS & ELECTRICALS LTD., Elcoma Dept., Band Box Building, 254-D Dr. Annie Besant Rd., BOMBAY - 400 025, Tel. 4220387/4220311.

**Indonesia:** P.T. PHILIPS-RALIN ELECTRONICS, Elcoma Div., Panim Bank Building, 2nd Fl., Jl. Jend. Sudirman, P.O. Box 223, JAKARTA, Tel. 7161313.

**Ireland:** PHILIPS ELECTRICAL (IRELAND) LTD., Newstead, Clonskeagh, DUBLIN 14, Tel. 69 33 55.

**Italy:** PHILIPS S.p.A., Sezione Elcoma, Piazza IV Novembre 3, I-20124 MILANO, Tel. 2-6752-1.

**Japan:** NIHON PHILIPS CORP., Shuwa Shinagawa Bldg., 26-33 Takahawa 3-chome, Minato-ku, TOKYO (108), Tel. 448-5611.  
(IC Products) SIGNETICS JAPAN LTD., 8-7 Sanbancho Chiyoda-ku, TOKYO 102, Tel. (03) 230-1521.

**Korea (Republic of):** PHILIPS ELECTRONICS (KOREA) LTD., Elcoma Div., Philips House, 260-199 Itaewon-dong, Yongsan-ku, SEOUL, Tel. 794-4202.

**Malaysia:** PHILIPS MALAYSIA SDN. BERHAD, No. 4 Persiaran Barat, Petaling Jaya, P.O.B. 2163, KUALA LUMPUR, Selangor, Tel. 77 44 11.

**Mexico:** ELECTRONICA, S.A de C.V., Carr. México-Toluca km. 62.5, TOLUCA, Edo. de México 50140, Tel. Toluca 91 (721) 613-00.

**Netherlands:** PHILIPS NEDERLAND, Marktgroep Elconco, Postbus 90050, 5600 PB EINDHOVEN, Tel. (040) 79 33 33.

**New Zealand:** PHILIPS NEW ZEALAND LTD., Elcoma Division, 110 Mt. Eden Road, C.P.O. Box 1041, AUCKLAND, Tel. 605-914.

**Norway:** NORSK A/S PHILIPS, Electronica Dept., Sandstuveien 70, OSLO 6, Tel. 68 02 00.

**Peru:** CADESA, Av. Alfonso Ugarte 1268, LIMA 5, Tel. 326070.

**Philippines:** PHILIPS INDUSTRIAL DEV. INC., 2246 Pasong Tamo, P.O. Box 911, Makati Comm. Centre, MAKATI-RIZAL 3116, Tel. 86-89-51 to 59.

**Ireland:** PHILIPS ELECTRICAL (IRELAND) LTD., Newstead, Clonskeagh, DUBLIN 14, Tel. 69 33 55.

**Portugal:** PHILIPS PORTUGUESA S.A.R.L., Av. Eng. Duarte Pacheco 6, 1009 LISBOA Codex, Tel. 68 31 21.

**Singapore:** PHILIPS PROJECT DEV. (Singapore) PTE LTD., Elcoma Div., Lorong 1, Toa Payoh, SINGAPORE 1231, Tel. 35 02 000.

**South Africa:** EDAC (PTY) LTD., 3rd Floor Rainer House, Upper Railway Rd. & Ove St., New Doornfontein, JOHANNESBURG 2001, Tel. 614-2362/9.

**Spain:** MINIWATT S.A., Balmes 22, BARCELONA 7, Tel. 301 63 12.

**Sweden:** PHILIPS KOMPLEMENTER A.B., Lidingövägen 50, S-11584 STOCKHOLM 27, Tel. 08/7822100.

**Switzerland:** PHILIPS A.G., Elcoma Dept., Allmendstrasse 140-142, CH-8027 ZÜRICH, Tel. 01-48822 11.

**Taiwan:** PHILIPS TAIWAN LTD., 3rd Fl., San Min Building, 57-1, Chung Shan N. Rd, Section 2, P.O. Box 22978, TAIPEI, Tel. (02)-5631717.

**Thailand:** PHILIPS ELECTRICAL CO. OF THAILAND LTD., 283 Silom Road, P.O. Box 961, BANGKOK, Tel. 233-6330-9.

**Turkey:** TÜRK PHILIPS TICARET A.S., Elcoma Department, İnönü Cad. No. 78-80, ISTANBUL, Tel. 43 59 10.

**United Kingdom:** MULLARD LTD., Mullard House, Torrington Place, LONDON WC1E 7HD, Tel. 01-580 6633.

**United States:** (Active Devices & Materials) AMPEREX SALES CORP., Providence Pike, SLATERSVILLE, R.I. 02876, Tel. (401) 762-9000.  
(Passive Devices) MEPCO/ELECTRA INC., Columbia Rd., MORRISTOWN, N.J. 07960, Tel. (201) 535-2000.  
(Passive Devices & Electromechanical Devices) CENTRALAB INC., 5855 N. Glen Park Rd., MILWAUKEE, WI 53201, Tel. (414) 228-7380.  
(IC Products) SIGNETICS CORPORATION, 811 East Arques Avenue, SUNNYVALE, California 94086, Tel. (408) 739-7700.

**Uruguay:** LUZILECTRON S.A., Avda Uruguay 1287, P.O. Box 907, MONTEVIDEO, Tel. 91 43 21.

**Venezuela:** IND. VENEZOLANAS PHILIPS S.A., Elcoma Dept., A. Ppal de los Ruices, Edif. Centro Colgate, CARACAS, Tel. 36 05 11

**For all other countries apply to:** Philips Electronic Components and Materials Division, International Business Relations, Building BAE, P.O. Box 218, 5600 MD EINDHOVEN, The Netherlands, Tel. +31 40 72 33 04, Telex 35000 phtcnl

This information is furnished for guidance, and with no guarantee as to its accuracy or completeness; its publication conveys no licence under any patent or other right, nor does the publisher assume liability for any consequence of its use; specifications and availability of goods mentioned in it are subject to change without notice; it is not to be reproduced in any way, in whole or in part, without the written consent of the publisher.